

15008C PONY OPC (5HP)(S/N 15008C0400101-UP)
ELECTRIC START ASSEMBLY

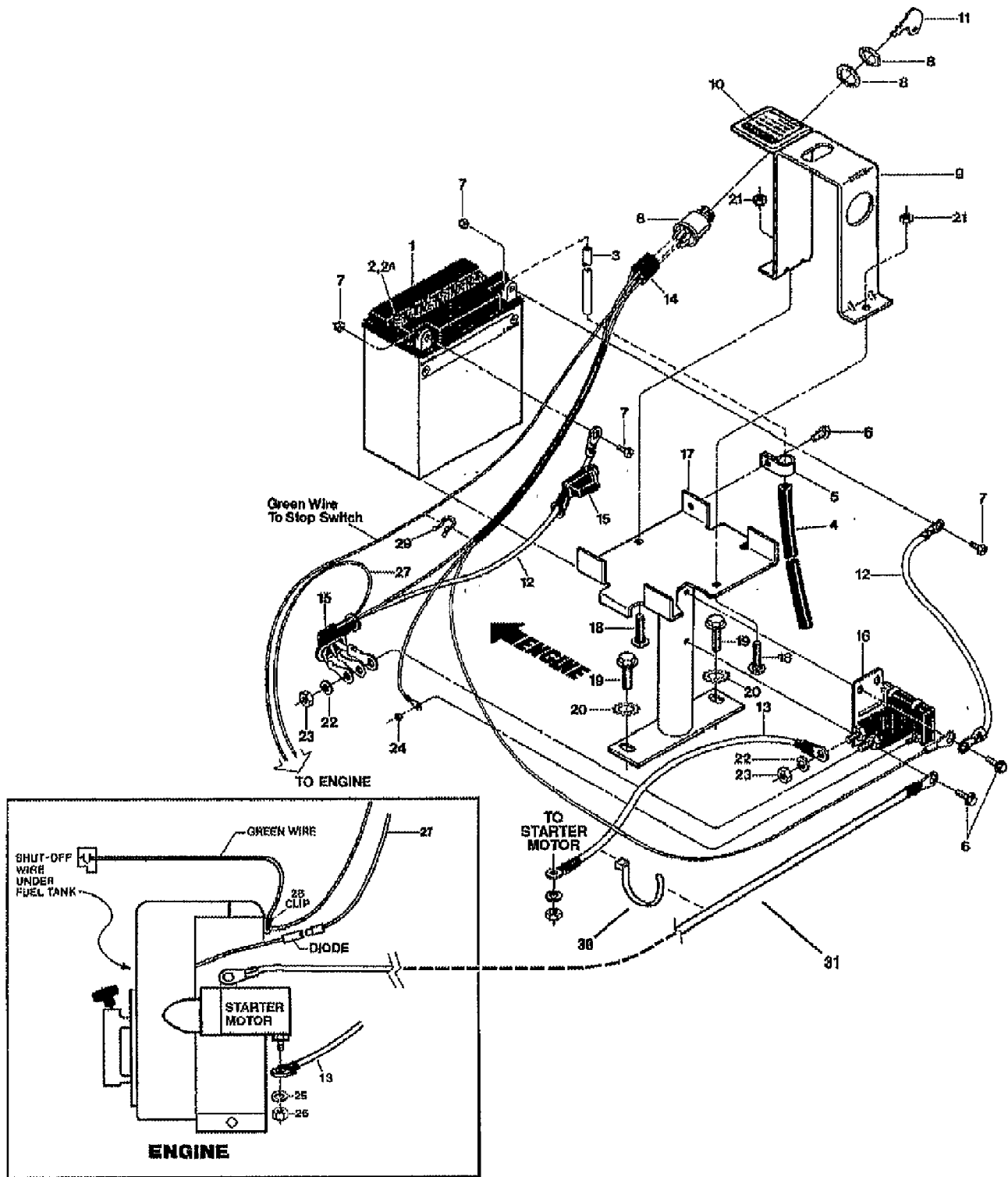

15008C PONY OPC (5HP)(S/N 15008C0400101-UP)
ELECTRIC START ASSEMBLY

Page 2 of 19

Ref #	Part Number	Qty	S/P/F	Description
1	96512	0		BATTERY
2	9462	0		CAP-YELLOW
2A	9248	0		CAP-BATTERY WHITE (PONY)
3	9009	0	S	TUBE-VENT BATTERY/HSE
4	1475	0		TUBING-RUBBER
5	9224	0		CLAMP
6	9552	0	S	SCR-HWH 1/4-20 X .5 STH
7	11361	0		HDW PKG-BATTERY TERMINAL
8	1908112	0	S	ASSM-KEYSWITCH ELEC TLR
9	1904570	0		KEYSWITCH W/DECAL PONY
10	1904548	0	S	DECAL-IGNITION TILLERS
11	96520	0	S	KEYS-IGN T/BLAZER 1 PAIR
12	96509	0		CABLE-BATTERY-12"
13	96510	0	S	CABLE-BATTERY 12"
14	1908118	0	S/F	KIT-WIRE HARNESS ASSM (AVAILABLE AS COMPLETE ASSEMBLY ONLY)
15	97020	0	S	BOOT-BATTERY CABLE
16	96514	0	S	SOLENOID
17	20837	0	S	BRKT-BATTERY OPC PNT
18	1186023	0		NUT-WELD 5/16-18
19	1186331	0	S	SCR-HFLK 5/16-18X1.00 ZP
20	1177548	0	S	WASHER-LK .312 EXT TOOTH
21	1186389	0	/P	NUT-HF/LK 1/4-20 ZP
22	1100242	0	S	WASHER-LK .312 ZP
23	1186211	0	/P	NUT-HEX 5/16-24
24	9853	0	S	NUT W/LKWASHER #10-32 ZP
25	0	0		LOCKWASHER
26	0	0		NUT
27	1901894	0	/P	WIRE-RECHARGE 5&7 BRIGGS
28	9218	0	S	CLIP-SPECIAL
29	9265	0	S	TIE-TWIST LOCK
30	9202	0	S	TIE-RED
31	1901202	0	/P	CABLE-BATTERY 15"

15008C PONY OPC (5HP)(S/N 15008C0400101-UP)
ENGINE, PULLEYS & BELTS

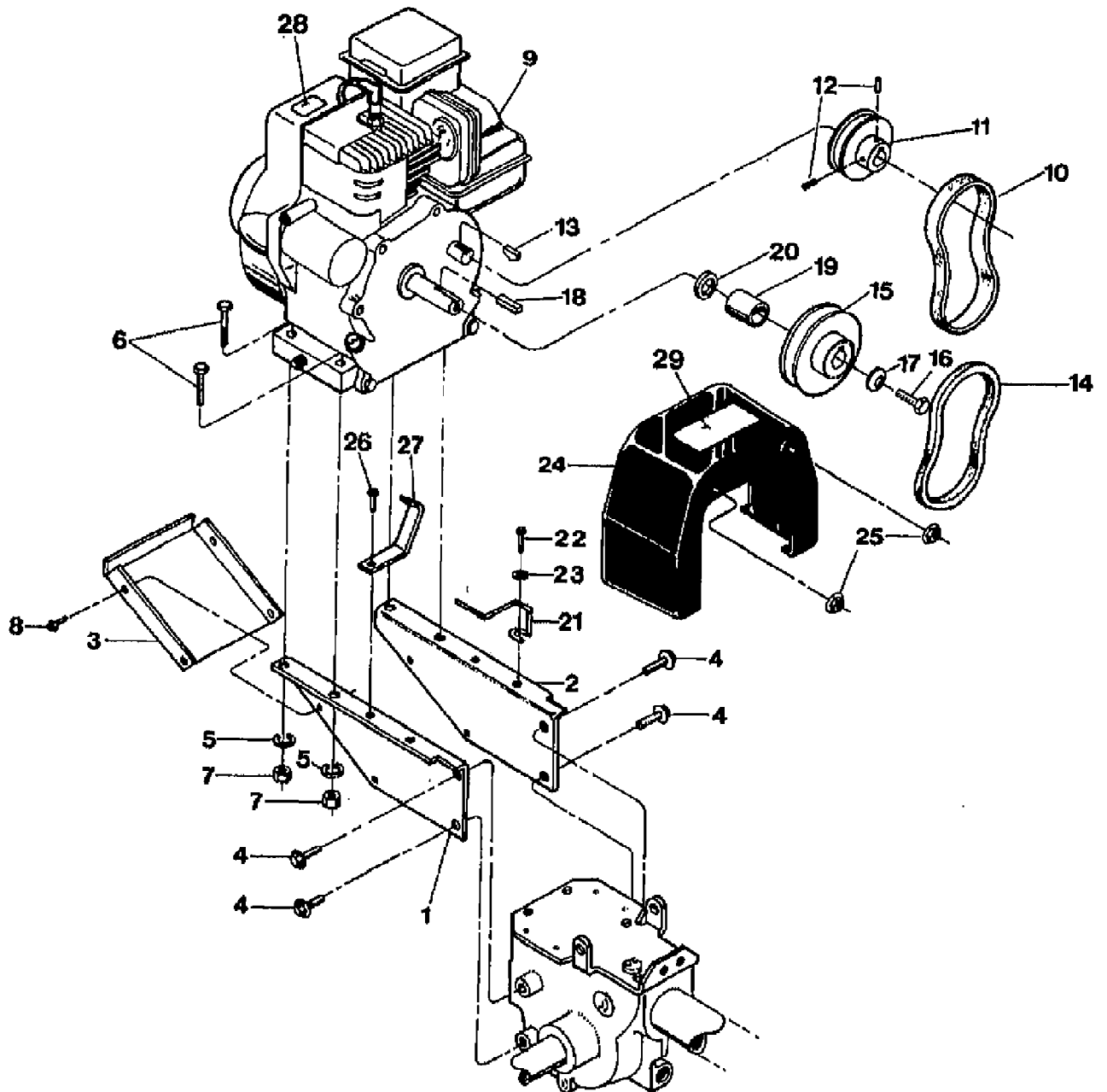

#1900706 RED SPRAY PAINT

15008C PONY OPC (5HP)(S/N 15008C0400101-UP)
ENGINE, PULLEYS & BELTS

Page 4 of 19

Ref #	Part Number	Qty	S/P/F	Description
1	20754	0		BRKT-ENG LT P4
2	20755	0	S	BRKT-ENG RT PNT
3	20673	0	S	PAN-ENG BRKT PNT
4	90044	0		SCR-HFLK 5/16-18X.75 ZP
5	9912	0		WASHER-LK .312 ZP
6	9758	0		SCR-HH 5/16-18X1.5 G5 ZP
7	9801	0		NUT-HEX 5/16-18 ZP
8	1900396	0	/P	SCR-HW M10-32X.5 THRD ROLL
8	9768	0		SCR-HH SEMS 10-32 X .5 ZP (EARLY UNITS)
9	0	0		ENGINE,B&S 5HP STANDARD RECOIL WITH MAGNETRON MODEL 130292 TYPE 3220-01
9	0	0		ENGINE,B&S 5HP ELEC. START WITH MAGNETRON MODEL 130297 TYPE 3221-01
10	97075	0	S	BELT-FLAT (SEE BELT SET BELOW)
11	20881	0		PULLEY-REV DRILL/TAP
12	9561	0	S	SCR-SS 1/4-20 X .25 (SECURES REVERSE ENGINE PULLEY)
13	9361	0	S	KEY-WOODRUFF #5
14	1909404	0	/P	BELT-V GROOVE FWD SMFRAME (SEE BELT SET BELOW)
15	20765	0		PULLEY-ENGINE MACH
16	9655	0	S	SCR-HH 5/16-24X.75 G5 ZP
17	9944	0	S	WASHER-.827X.331X.098 (CONCAVE SURFACE FACES FORWARD PULLEY)
18	9301	0	S	KEY-.188 SQX1.0
19	97077	0		SPACER-.938X.755X1.19 (ON FORWARD PTO SHAFT BETWEEN ENGINE & FORWARD PULLEY)
20	1138-2	0	S	SHIM-1.0X.7656X.031 (ON FORWARD PTO SHAFT BETWEEN ENGINE & SPACER)
21	20555	0		GUIDE-BELT FWD
22	9573	0	S	SCR-HWH 1/4-20 X .75 STH
23	9900	0		WASHER-FLAT 1/4 SAE
24	20916	0	S	COVER-BELT W/DECAL (INCL. 29)
25	9848	0		NUT-HFLK 5/16-18 ZP
	11535	0		KIT-SVC 5HP PONY VA TILLER (INCL. 10 & 14)
26	9552	0	S	SCR-HWH 1/4-20 X .5 STH
27	20514	0		GUIDE-BELT REV PNT
28	1900767	0		DECAL-STABIL STARTING
29	20818	0	S	DECAL-BELT COVER OPC
	1900706	0	S	PAINT-RED SPRAYCAN POWDER

15008C PONY OPC (5HP)(S/N 15008C0400101-UP)
FORWARD/REVERSE IDLER ASSEMBLY

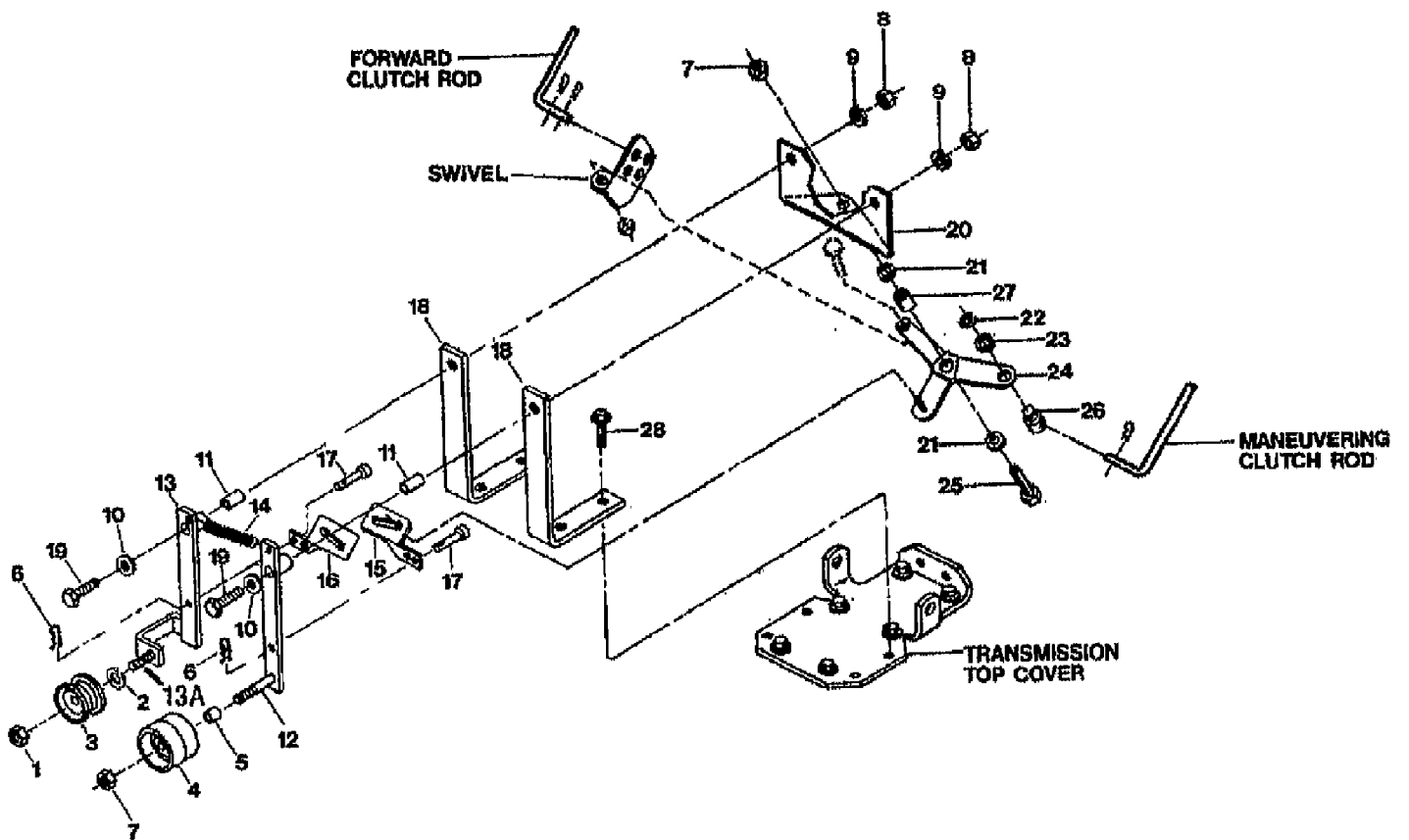

15008C PONY OPC (5HP)(S/N 15008C0400101-UP)
FORWARD/REVERSE IDLER ASSEMBLY

Page 6 of 19

Ref #	Part Number	Qty	S/P/F	Description
1	9837	0	S	NUT-LOCK 3/8-16 NYLON ZP
2	20513	0		BUSHING-.54X.38X.08
3	9460	0	F	IDLER-REV
3	1909266	0	S/F	PULLEY-IDLER REVERSE
4	9090	0	S	PULLEY-IDLER FORWARD
5	9091	0		SPACER-IDLER FWD
6	9338	0	S	PIN-CLIP .08
7	9807	0		NUT-H/LK 3/8-16
8	9801	0		NUT-HEX 5/16-18 ZP
9	9912	0		WASHER-LK .312 ZP
10	20545	0	S	WASHER-#.75X.32X.09 ZP
11	9479	0	S	BUSHING-.438X.323X.712
12	20899	0	S	ARM-IDLER FWD PNT
13	20760	0	F	IDLER-REV
13	1909682010	0	F	ARM-IDLER REV RED
13A	90029	0	F	SCR-HH 3/8-16X1.25
14	1492	0	S	SPRING-.436 X 3.25
15	20517-01	0		LINK-FWD
16	20517-02	0		LINK-REV
17	9340	0		PIN-CLEVIS .375X.719 ZP
18	20751	0		MOUNT BAR-PNT (20691)
19	9966	0		SCR-HH 5/16-18X2.25 G5ZP
20	20842	0	S	SHIFT BASE-OPC PNT
21	20553	0	S	SPACER-.88X.385X.09 ZP
22	9532	0	S	RING-KLIP .500 ZINC
23	20546	0	S	WASHER-#.88X.51X.063 ZP
24	20838	0	S	BELLCRANK-OPC PNT
25	9712	0		SCR-HH 3/8-16X1.25
26	20506	0		PIVOT-ROD (FOR MANEUVERING CLUTCH LEVER)
27	20532	0	S	BUSHING-.5X.38X.4
28	90045	0		SCR-HFLK 5/16-18X1.00 ZP

15008C PONY OPC (5HP)(S/N 15008C0400101-UP)
HANDLE BARS & CONTROL LEVERS

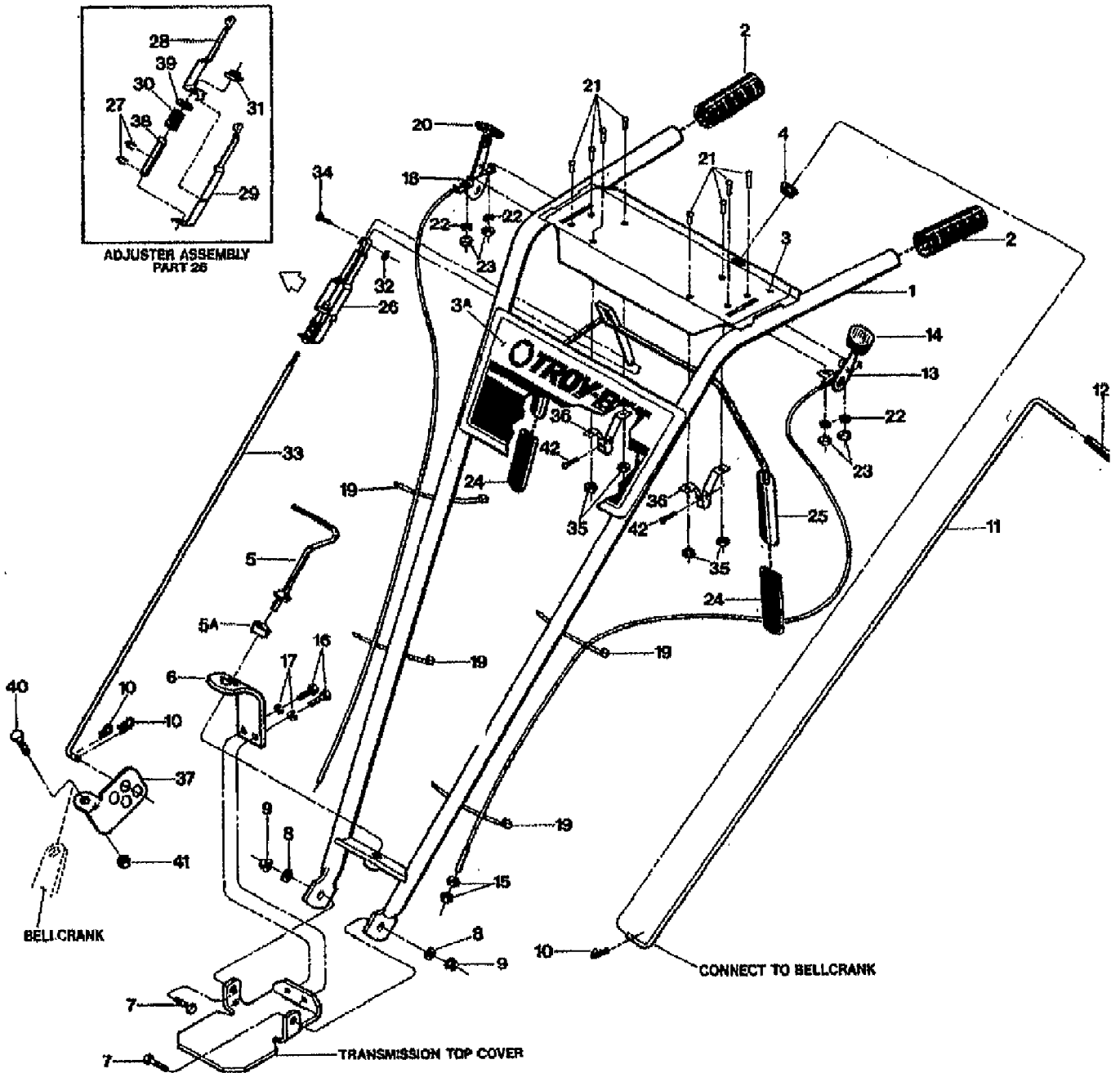

#1900706 RED SPRAY PAINT

15008C PONY OPC (5HP)(S/N 15008C0400101-UP)
HANDLE BARS & CONTROL LEVERS

Page 8 of 19

Ref #	Part Number	Qty	S/P/F	Description
1	20928	0	S	ASSM-HANDLEBAR W/GRIPS (INCL. 2,3,3A,4)
2	9126	0	S	GRIP-H/B 1" PONY/P-J OPC
3	1901867	0	/P	DECAL-CONTROL PANEL
3A	20924	0	S	DECAL-GRAPHICS PANEL PONY
4	9251	0		BUSHING-NYLON (PART OF OPERATOR CONTROL PANEL)
5	20703	0		ASSM-STUD H/B
5A	9955	0	S	WASHER-1.0X.38X.375
6	1900475010	0	/P	PLATE-HANDLEBAR ADJUST
7	9711	0		SCR-HH 3/8-16X1.0 G5 ZP (USED TO ATTACH HANDLEBARS TO TABS ON TRANS. TOP COVER)
8	9904	0	S	WASHER-FLAT 3/8 SAE (HANDLEBAR ATTACHMENT)
9	9837	0	S	NUT-LOCK 3/8-16 NYLON ZP (HANDLEBAR ATTACHMENT)
10	9338	0	S/F	PIN-CLIP .08
11	20830	0		ROD-REV W/GRIP OPC (INCL. #9198)
12	9198	0		GRIP-CONTROL ROD
13	9442	0	S	CABLE-WHEEL CLUTCH OPC (INCL. 14,15,19,21-23)
14	9057	0	S	KNOB-WHEEL DRIVE CABLE
15	9826	0		NUT-HEX 5/16-24
16	9709	0	F	SCR-HH 3/8-16X.75 G5 ZP
17	9913	0	F	WASHER-LK .375 @ DEPL
18	9440	0		CABLE-THROTTLE PONY OPC
19	9202	0	S	TIE-RED (TO SECURE CABLES TO HANDLEBARS)
20	9212	0	S	KNOB-THROTTLE CABLE
21	9722	0		SCR-RH M10-32X.5 MACH
22	9909	0		WASHER-LK M10
23	9809	0		NUT-HH M10-32X.125
24	9390	0	S	GRIP-PADDLE SM FRAME OPC
25	20863	0	S	BAIL W/GRIPS OPC (INCL. TWO #24)
26	20862	0	S	ASSM-ADJUSTMENT OPC (INCL. 27-30, 38-39)
27	9532	0	S	RING-KLIP .500 ZINC
28	20808	0	S	ADJUSTER-RT SIDE OPC
29	20809	0	S	ADJUSTER-LT SIDE OPC
30	9059	0	S	SPRING-ADJUSTER OPC
31	9522	0		WELDNUT 5/16-18
32	9386	0		RING-KLIP .188 DIA
33	20831	0	S	ROD-CONTROL OPC
34	97083	0		ASSM-PIN & CLIP (SMALL FRAME)
35	9853	0	S	NUT W/LKWASHER #10-32 ZP
36	20806	0	S	BRACKET-BAIL OPC
37	20888	0	S	SWIVEL-SMALL FRAME
38	9432	0		BUSHING-.5X.334X2.88

15008C PONY OPC (5HP)(S/N 15008C0400101-UP)
HANDLE BARS & CONTROL LEVERS

Page 9 of 19

Ref #	Part Number	Qty	S/P/F	Description
39	9973	0		WASHER-.75X.51X.06 ZP
40	90070	0		SCR-HH 1/4-20X.75 G5 ZP
41	9811	0		NUT-LK 1/4-20
42	9552	0	S	SCR-HWH 1/4-20 X .5 STH
	1900706	0	S	PAINT-RED SPRAYCAN POWDER

15008C PONY OPC (5HP)(S/N 15008C0400101-UP)
HOOD & DEPTH REGULATOR

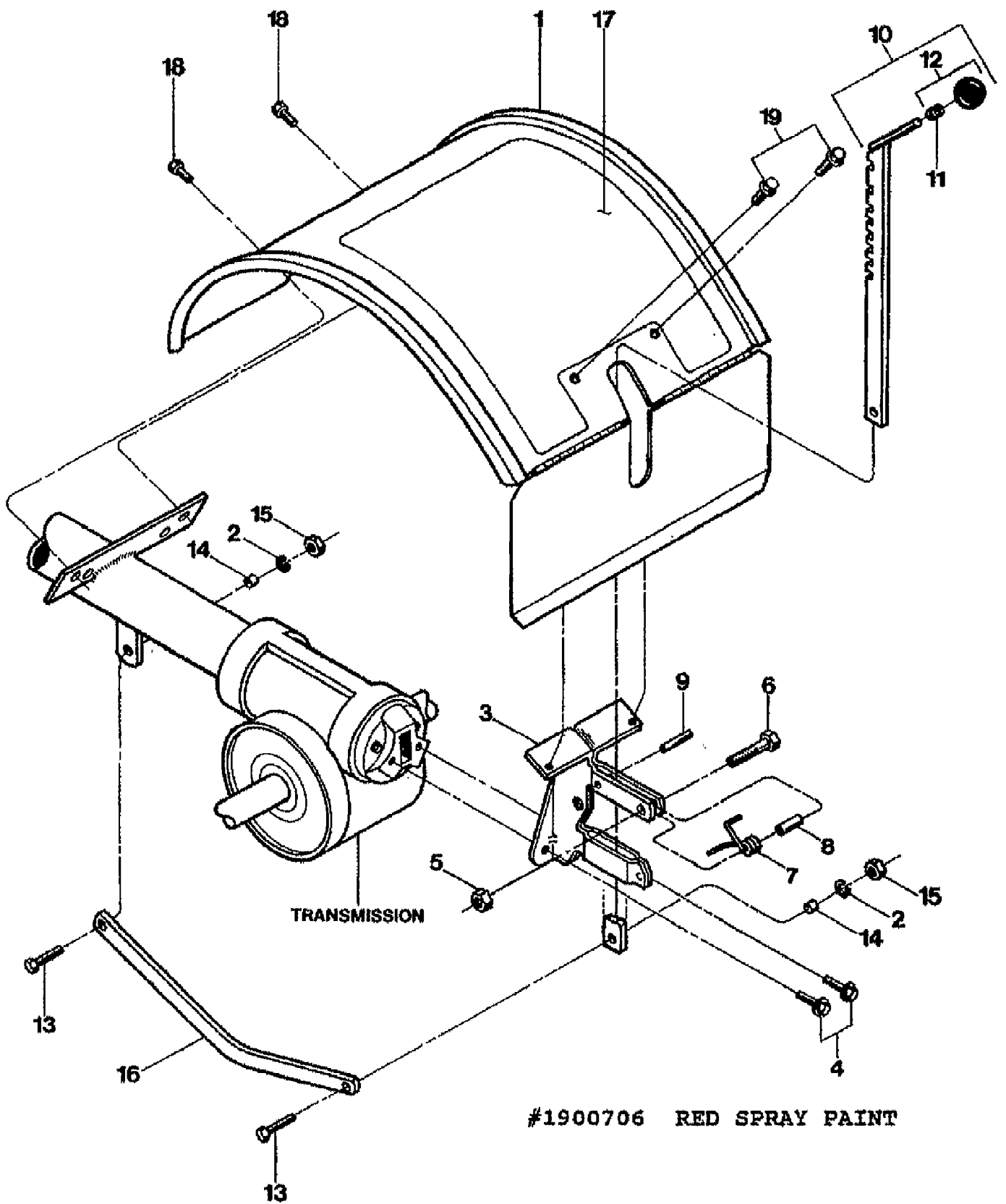

15008C PONY OPC (5HP)(S/N 15008C0400101-UP)
HOOD & DEPTH REGULATOR

Page 11 of 19

Ref #	Part Number	Qty	S/P/F	Description
1	20861	0	S	HOOD W/DECALS PONY OPC (INCL. 17)
2	1904568	0	S	HOOD W/DECALS PONY (INCL 17) (15008,15009, 0400101 & HIGHER)
2	9913	0		WASHER-LK .375 @ DEPL
3	2527	0	S	BRKT W/ROLL PIN (9308)
4	90038	0		SCR-HFLK 5/16-18X.62 G5ZP
5	9811	0		NUT-LK 1/4-20
6	9734	0		SCR-HH 1/4-20X1.0
7	9384	0	S	SPRING-TORSION
8	9438	0		SPACER-.250X.343X.375
9	9308	0	S	PIN-ROLL .25 X 1
10	1117A	0	S	DEPTH REGULATOR W/KNOB (INCL. 11 & 12)
11	9120	0	S	RING-TOLERANCE .5325 ID
12	9119	0	S	KNOB-CONTROL (INCL. 11)
13	9712	0		SCR-HH 3/8-16X1.25
14	1113-1	0	S	BUSHING-.5X.375X.3
15	9802	0		NUT-HEX 3/8-16 ZP
16	20775	0	S	DRAG BAR-BENT
17	20925	0	S	DECAL-HOOD OPER INST
17	1904545	0		DECAL-HOOD INST PONY (15008 & 15009 0400101 & HIGHER)
18	9553	0	S	SCR-HWH 5/16-18 X .5 STH
19	9552	0	S	SCR-HWH 1/4-20 X .5 STH (ATTACHES HOOD TO DEPTH REGULATOR BRACKET)
	1900706	0	S	PAINT-RED SPRAYCAN POWDER

15008C PONY OPC (5HP)(S/N 15008C0400101-UP)
MAIN DRIVE SHAFT & GEAR ASSEMBLY

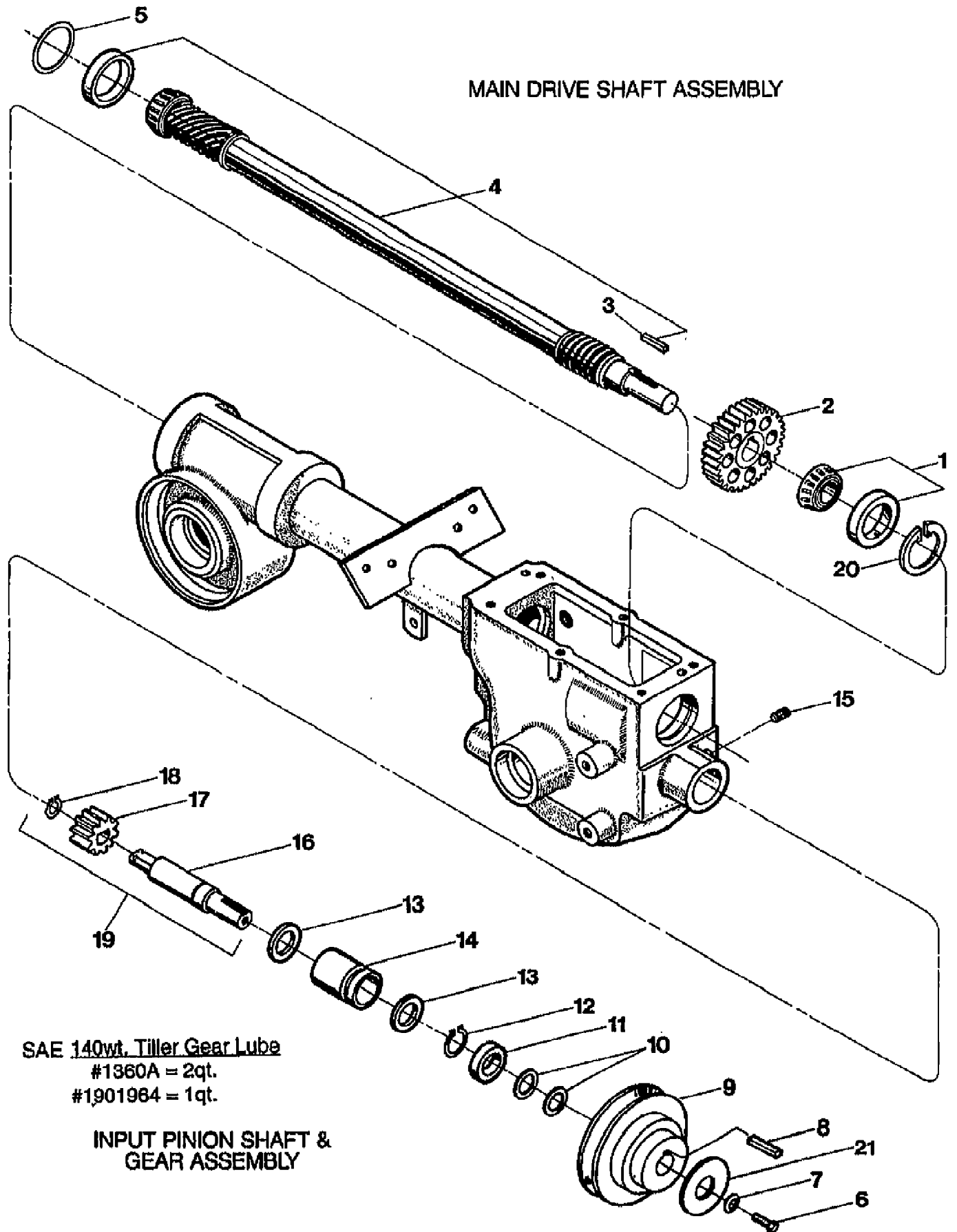

15008C PONY OPC (5HP)(S/N 15008C0400101-UP)
MAIN DRIVE SHAFT & GEAR ASSEMBLY

Page 13 of 19

Ref #	Part Number	Qty	S/P/F	Description
1	1714	0	S	KIT-BRG CONE&RACE-DRIVESHAFT(FRONT OF DRIVE SHAFT)
2	20718	0	S	GEAR-SPUR 30 TEETH
3	9301	0	S	KEY-.188 SQX1.0
4	10360	0	F	KIT-DRIVESHAFT
4	11603	0	F	KIT-DRIVESHAFT SMFR
5	1224-1	0	S/F	SHIM-1.75X1.5X.01 (SEE NOTE 1)
5	1224-2	0	S/F	SHIM-1.75X1.5X.03 (SEE NOTE 1)
5	1224-3	0	S/F	SHIM-1.75X1.5X.005 (SEE NOTE 1)
5	1325C	0	S	SHIM SET-DRIVESHAFT-HORSE
6	9655	0	S	SCR-HH 5/16-24X.75 G5 ZP
7	9944	0	S	WASHER-.827X.331X.098 (CONCAVE SURFACE (FACES PULLEY)
8	9301	0	S	KEY-.188 SQX1.0
9	20880	0		PULLEY-TRANS MACH
10	1440	0	S	WASHER # .875 X .65 X .06
11	85030	0		SEAL-PINION SHAFT PT/85030/00
12	9500	0	S	RING-RETAIN EXT .707 ID
13	9953	0	S	WASHER-1.022X.752X .059
14	9428	0	S	BUSHING-1.24X.75X1.8 GRVD
15	9677	0	S	SCR-SS 5/16-18X.375
16	20791	0	S	SHAFT-PINION(P-V)
17	20792	0	S	GEAR-PINION P/M
18	9093	0	S	RING-BOWED EXT .461 ID
19	20799	0	S	PINION W/GEAR&SNAP RING
20	9517	0	S	RING-RETAINING 5000-181
21	94018	0	S	WASHER-2.5X.316X.06
	1360A	0		OIL (1901964)
	1901964	0		OIL-GEAR 1 QT 140WT

15008C PONY OPC (5HP)(S/N 15008C0400101-UP)
 TINES & WHEELS

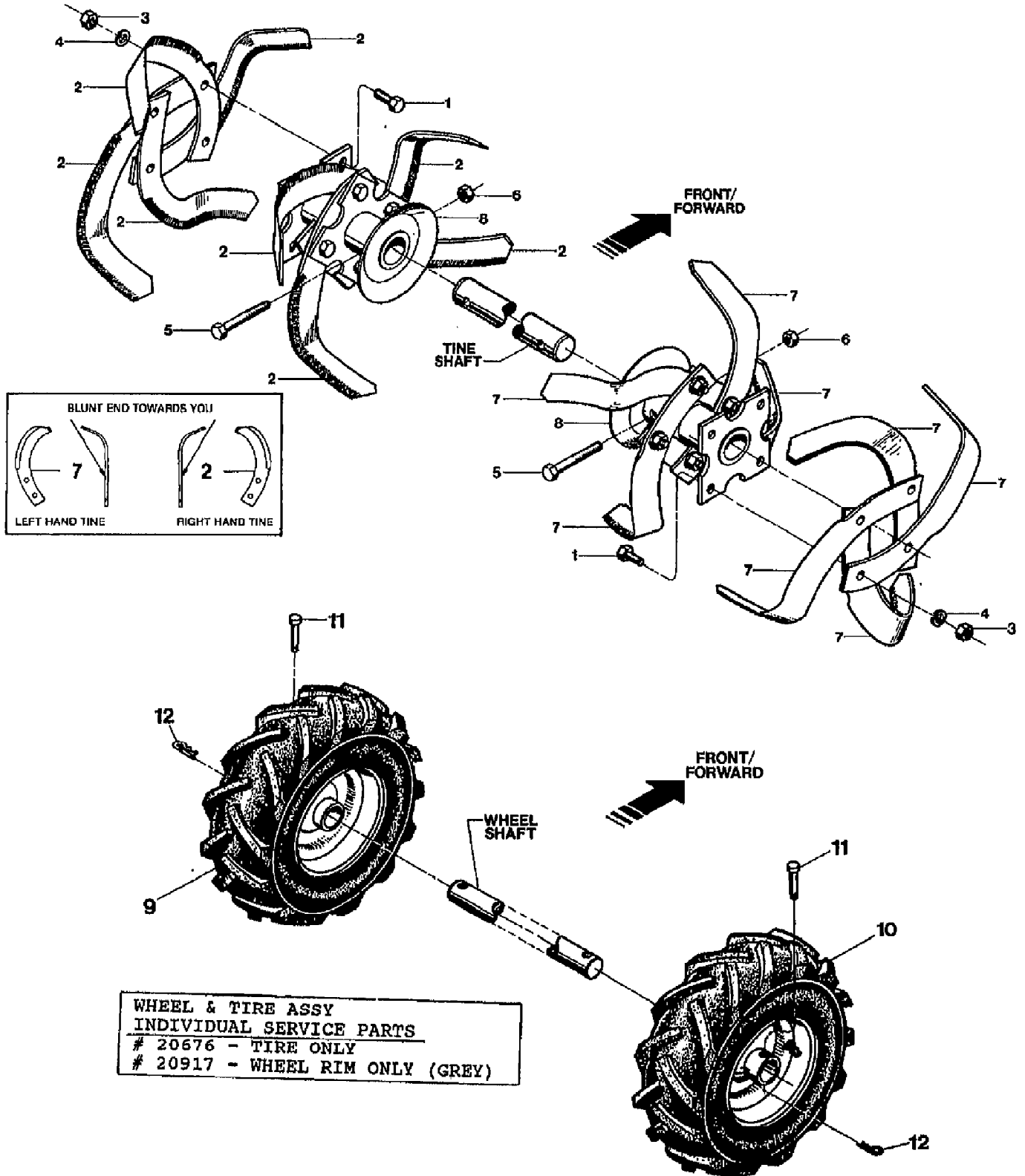

15008C PONY OPC (5HP)(S/N 15008C0400101-UP)
TINES & WHEELS

Page 15 of 19

Ref #	Part Number	Qty	S/P/F	Description
1	9711	0		SCR-HH 3/8-16X1.0 G5 ZP
2	1270-2A	0	S	TINE-BOLO RT W/HDW
3	9802	0		NUT-HEX 3/8-16 ZP
4	9913	0		WASHER-LK .375 @ DEPL
5	9761	0		SCR-HH 3/8-16X2.00 G8
6	9807	0		NUT-H/LK 3/8-16
7	1270-1A	0	S	TINE-BOLO LT W/HDW
8	1902154010	0	S	HOLDER-TINE PONY
	1901118	0	S	TINES-BOLO HORSE/PONY/ECONO (INCL. 8 EA RH & LH TINES, 16 EA # 1,3,4)
	10802	0	S/F	TINES-CUSTOM TILLING (INCL.8 #2475-1, 8 #2475 -2, 16 #9711, & 16 #9807)
	2475-1	0	S/F	TINE-HARD FACED LT
	2475-2	0	S/F	TINE-HARD FACED RT
	9807	0	F	NUT-H/LK 3/8-16
9	20918-01	0	S	ASSM-TIRE&WHL LH GRAY
10	20918-02	0	S	ASSM-TIRE&WHL RH GRAY
9	20678-01	0		ASSM-TIRE LT 4.10 X 6"
10	20678-02	0		ASSM-TIRE RT 4.10 X 6"
	20676	0		TIRE-4.10 X 6"
	20917	0		RIM-WHEEL 6" GRAY
11	9380	0	S	PIN-CLEVIS
12	9338	0	S	PIN-CLIP .08

15008C PONY OPC (5HP)(S/N 15008C0400101-UP)
TRANS. HSG. & SEALS/GASKETS

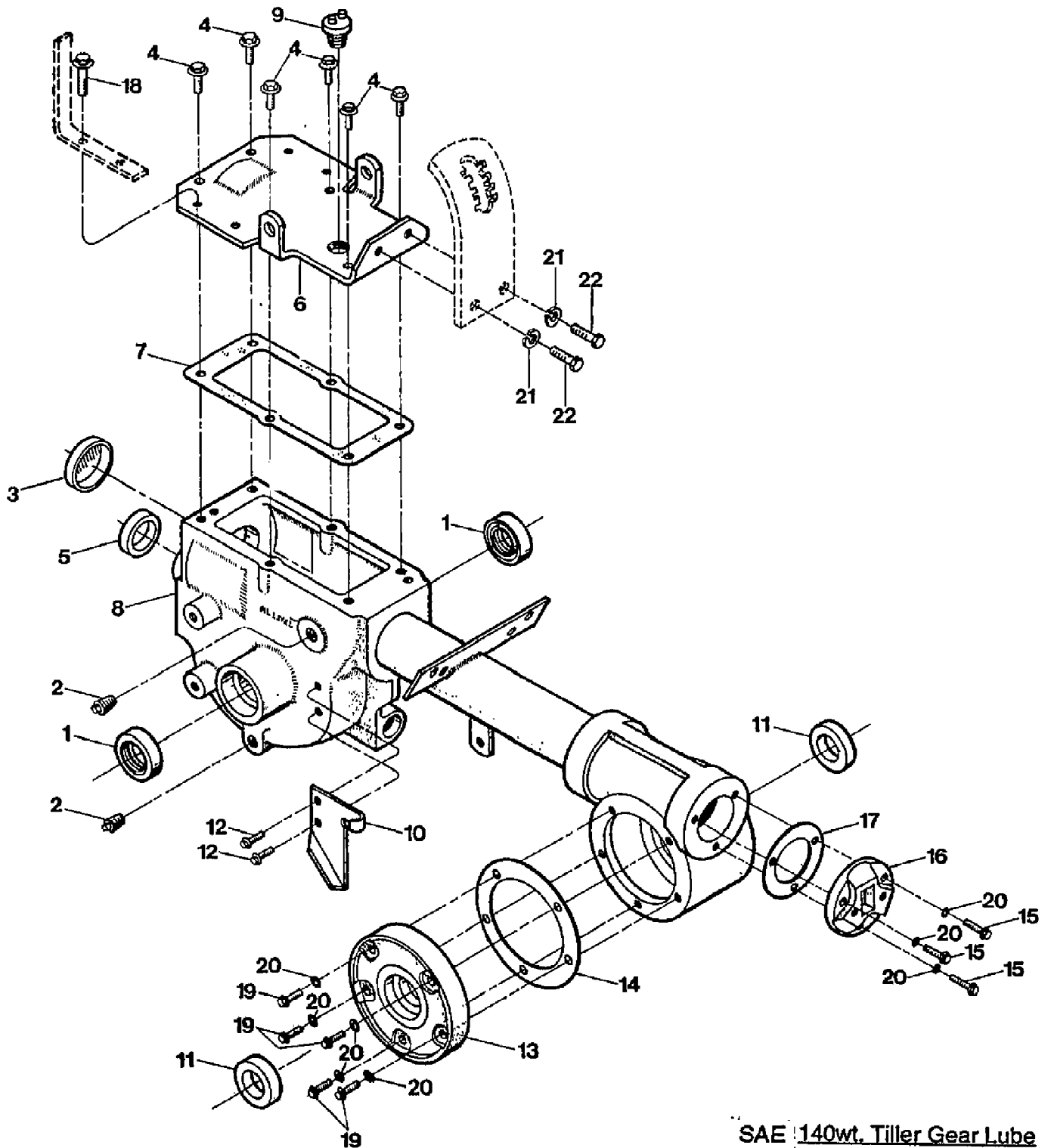

SAE 140wt. Tiller Gear Lube
#1360A = 2qt.
#1901964 = 1qt.

15008C PONY OPC (5HP)(S/N 15008C0400101-UP)
TRANS. HSG. & SEALS/GASKETS

Page 17 of 19

Ref #	Part Number	Qty	S/P/F	Description
1	9621	0	S	SEAL-OIL WHEELSHAFT
2	9726	0	S	PLUG-PIPE 1/4 NPT
3	97076	0	S	SEAL-BORE
4	90044	0		SCR-HFLK 5/16-18X.75
5	85030	0		SEAL-PINION SHAFT PT/85030/00
6	11513	0		KIT-COVER TRANS W/HDW (INCL. FOUR #18 & TWO EA. # 21 & 22)
7	20694	0	S	GASKET-TRANS COVER
8	20893	0	S	ASSM-TRANS A-UNIT P/ECHO
9	9467	0	S	PLUG-OIL FILL 3/4-10
10	20889	0		PLATE-CABLE MT PNT
11	97073	0	S	SEAL-TILLER SHAFT
12	90038	0		SCR-HFLK 5/16-18X.62 G5
13	20873	0	S	COVER-TILLER HSG MACH (INCL. 5 #19)
14	1129-1	0	S	GASKET-TILLER COVER (FITS ALL COVERS)
15	1915089	0	/P	KIT-SEALING SCRS (3)
16	1115	0		CAP-REAR #1115
17	1124-2	0	S	GASKET-BRG COVER
18	90045	0		SCR-HFLK 5/16-18X1.00
19	1908211	0	S	SCR-HXSKT 1/4-20X.625
20	0	0		ITEM NO LONGER USED
21	9913	0		WASHER-LK .375
22	9709	0		SCR-HH 3/8-16X.75 G5
	1360A	0		OIL (1901964)
	1901964	0		OIL-GEAR 1 QT 140WT

15008C PONY OPC (5HP)(S/N 15008C0400101-UP)
WHEEL & TILLER SHAFT ASSEMBLY

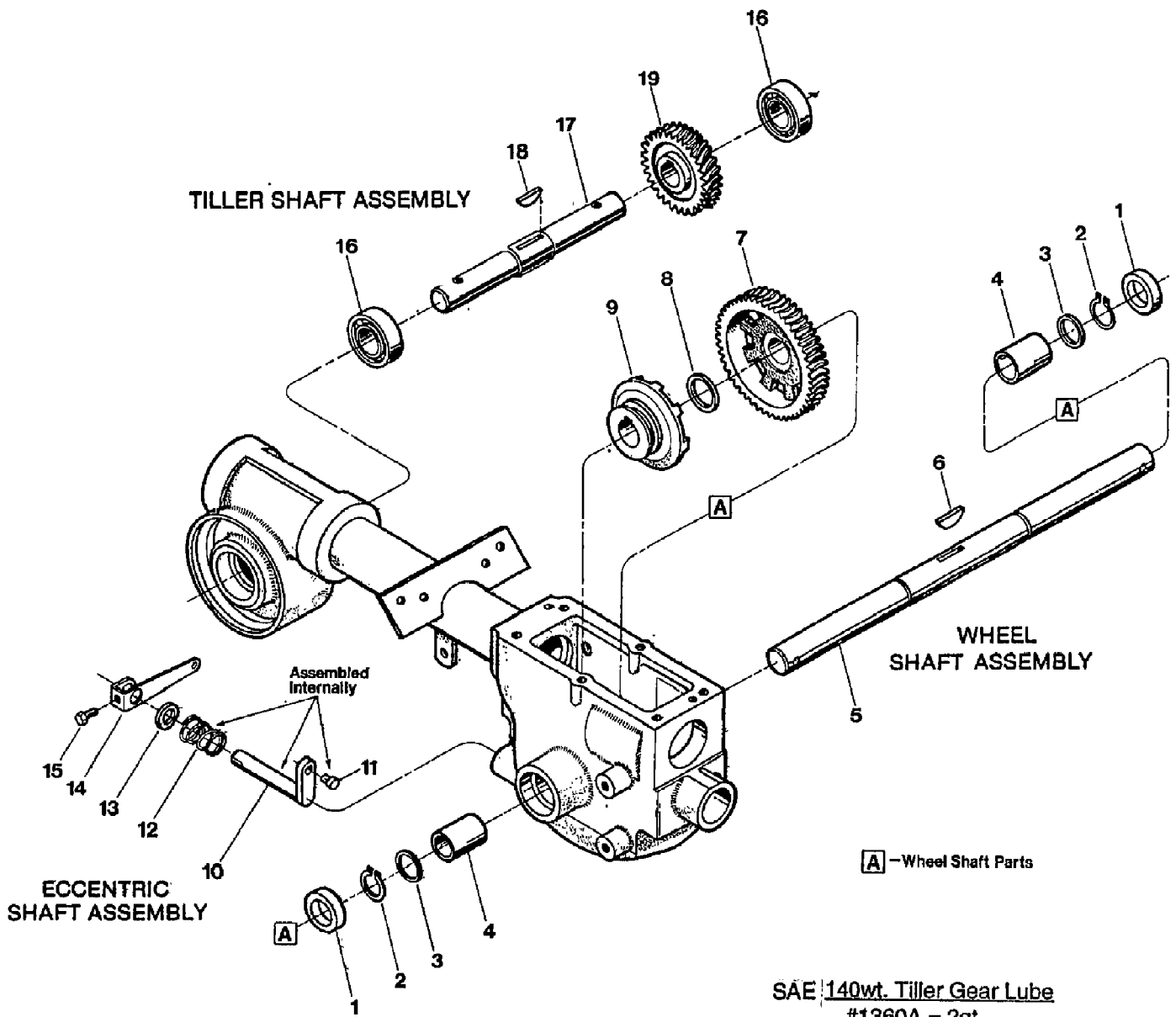

SAE 140wt. Tiller Gear Lube
#1360A = 2qt.
#1901964 = 1qt.

15008C PONY OPC (5HP)(S/N 15008C0400101-UP)
WHEEL & TILLER SHAFT ASSEMBLY

Page 19 of 19

Ref #	Part Number	Qty	S/P/F	Description
1	9621	0	S	SEAL-OIL WHEELSHAFT - LEFT AND RIGHT SIDES
2	9511	0	S	RING-HEAVY EXT .906 ID
3	1166-1	0	S	SHIM-1.375X1.015X.062
3	1166-2	0	S	SHIM-1.375X1.015X.03
3	1166-3	0	S	SHIM-1.375X1.015X.015
3	1166-4	0	S	SHIM-1.375X1.015X.01
4	1086	0	S	BUSHING-1.25X1.005X1.5
5	20711	0	S	ASSM-WHEEL SHAFT W/KEY
6	9373	0	S	KEY-HI PRO .25X1.312
7	20535	0	F	GEAR-WORM 46 TEETH MACH
7	20914	0	S/F	GEAR-WHEEL DRIVE MACH
8	9935	0	S	WASHER-1.468X1.016X.062
9	20712	0	S	CLUTCH-MACH
10	20879	0	S	WELD-ECCENTRIC
11	1442	0	S	PIN-.375 X .72
12	9055	0	S	SPRING-.850 X .875 LONG
13	9622	0	S	SEAL-OIL ECCENTRIC
14	20757	0		LEVER-CABLE ADJ PNT
15	9743	0		SCR-HH 1/4-20X.5 GR5 YEL
16	97074	0	S	BEARING-BALL
17	20896	0	S	SHAFT-W/KEY (TILLER)
18	1104	0	S	KEY-WOODRUFF .25X1.12
19	20776	0		GEAR-TILLER MACH
19	20913	0	S	GEAR-TILLER MACH
	1360A	0		OIL (1901964)
	1901964	0		OIL-GEAR 1 QT 140WT