

Ref #	Part Number	Qty	Description
	1 37674	1	Cylinder (Incl. 2, 20 & 150)
	2 26727	2	Dowel Pin
	6 33734	1	Breather Element
	7 36557	1	Breather Ass'y. (Incl. 6 & 12A)
	12 37944	1	Breather Tube
	12B 36694	1	Breather Tube Elbow
	12A 36558	1	Breather Cover & Tube (Incl. 12B)
	14 28277	1	Washer
	15 30589	1	Governor Rod (Incl. 14)
	16 34839A	1	Governor Lever
	17 31335	1	Governor Lever Clamp
	18 651018	1	Screw, T-15, 8-32 x 19/64"
	19 36281	1	Extension Spring
	20 32600	1	Oil Seal
	30 37459	1	Crankshaft
	40 40027	1	Piston, Pin & Ring Set (Std.)
	40 40028	1	Piston, Pin & Ring Set (.010" OS)
	41 40025	1	Piston & Pin Ass'y. (Std.) (Incl. 43)
	41 40026	1	Piston & Pin Ass'y. (.010" OS)(Incl. 43)
	42 40006	1	Ring Set (Std.)
	42 40007	1	Ring Set (.010" OS)
	43 20381	2	Piston Pin Retaining Ring
	45 36777	1	Connecting Rod Ass'y. (Incl. 46)
	46 32610A	2	Connecting Rod Bolt
	48 27241	2	Valve Lifter
	50 37460	1	Camshaft Exhaust (MCR) (Incl. 104)
	52 29914	1	Oil Pump Ass'y.
	69 37609	1	* Mounting Flange Gasket
	70 37608	1	Mounting Flange (Incl. 72-83,306,309A & 311A)
	72 37614	1	Oil Drain Plug
	75 27897	1	Oil Seal
	80 30574A	1	Governor Shaft
	81 30590A	1	Washer
	82 30591	1	Governor Gear Ass'y. (Incl. 81)
	83 30588A	1	Governor Spool
	86 650488	6	Screw, 1/4-20 x 1-1/4"
	89 611298	1	Flywheel Key
	90 611299	1	Flywheel
	92 650815	1	Belleville Washer
	93 650816	1	Flywheel Nut
	100 34443C	1	Solid State Ignition
	101 610118	1	Spark Plug Cover
	103 651007	2	Screw, T-15, 10-24 x 15/16"
	104 37480	1	Cam Bushing
	110 37047	1	Wire Ass'y
	119 37796	1	* Cylinder Head Gasket
	120 37714	1	Cylinder Head
	125 37288	1	Exhaust Valve (Std.) (Incl. 151)
	125 36780	1	Exhaust Valve (1/32" OS) (Incl. 151)
	126 37289	1	Intake Valve (Std.)(Incl. 151 & 151A)
	130 6021A	8	Screw, 5/16-18 x 1-7/16"
	135 35395	1	Resistor Spark Plug (RJ19LM)
	150 31672	2	Valve Spring
	151 31673	2	Valve Spring Cap
	151A 40017	1	Intake Valve Seal
	169 36783	1	* Valve Cover Gasket
	172 36784	1	Valve Cover
	174 30200	2	Screw, 10-24 x 9/16"

Ref #	Part Number	Qty	Description
178	29752	2	Nut & Lock Washer, 1/4-28
179	30593	1	Retainer Clip
182	6201	2	Screw, 1/4-28 x 7/8"
184	26756	1	* Carburetor To Intake Pipe Gasket
185	37466	1	Intake Pipe
186	34337	1	Governor Link
189	650839	2	Screw. 1/4-20 x 27/64"
191	36559A	1	S.E. Brake Bracket (Incl. 195)
195	610973	1	Terminal
200	33131A	1	Control Bracket (Incl. 202 thru 206)
202	36482	1	Compression Spring
203	31342	1	Compression Spring
204	651029	1	Screw, T-10, 5-40 x 7/16"
205	651019	1	Screw, T-10, 6-32 x 41/64"
206	610973	1	Terminal
207	34336A	1	Throttle Link
209	30200	2	Screw, 10-24 x 9/16"
210	27793	1	Conduit Clip
211	28942	1	Screw, 10-32 x 3/8"
223A	651074	1	Intake Pipe Stud
223	650451	1	Screw, 1/4-20 x 1"
224	36786	1	* Intake Pipe Gasket
238	650932	2	Screw, 10-32 x 49/64"
239	34338	1	* Air Cleaner Gasket
245	36905	1	Air Cleaner Filter
250	37122	1	Air Cleaner Cover
260	37848	1	Blower Housing
261	30200	2	Screw, 10-24 x 9/16"
262	650831	2	Screw, 1/4-20 x 1/2"
275	37529	1	Muffler
277	650988	2	Screw, 1/4-20 x 2-9/32"
279A	650902	1	Screw, 10-32 x 7/16"
279B	30200	1	Screw, 10-24 x 9/16"
279	650737	1	Screw, 1/4-20 x 1/2"
280	37618	1	Heat Shield
285	35000A	1	Starter Cup
287	650926	2	Screw, 8-32 x 21/64"
290	30705	1	Fuel Line
292	26460	2	Fuel Line Clamp
298	28763	3	Screw, 10-32 x 39/64"
300	34476A	1	Fuel Tank (Incl. 292 & 301)
301	33032	1	Fuel Cap Ass'y
305	35647A	1	Oil Fill Tube (Incl. 306)
306	37610	1	* "O"-Ring
307	35499	1	"O"-Ring
309A	650783	1	Screw, 10-24 x 3/4"
309	650562	1	Screw, 10-32 x 1/2"
310	35648	1	Dipstick
311A	37611	1	Hold Down Bracket
313	34080	1	Cam Bushing
324	33177	1	Terminal
355	590701	1	Starter Handle
361A	651075	1	Lock Nut, 10-24
370K	36695	1	Starter Decal
370C	37318	1	Primer Decal (3X)
380	640303	1	Carburetor (Incl. 184)

Ref #	Part Number	Qty	Description
390	590737	1	Rewind Starter (NOTE: This engine could have been built with 590694 starter.)
400	37613	1	* Gasket Set (Incl. items marked PK in notes)
416	37530	1	Spark Arrestor Kit (Incl. 417)(Optional)
417	650760	1	Screw, 8-32 x 3/8" (Optional)
420	730225A	1	SAE 30, 4-Cycle Engine Oil (Quart)
514	36458A	1	Brake Lock Out Device (Incl. 515)
515	650654	1	Screw, 6-32 x 3/8"

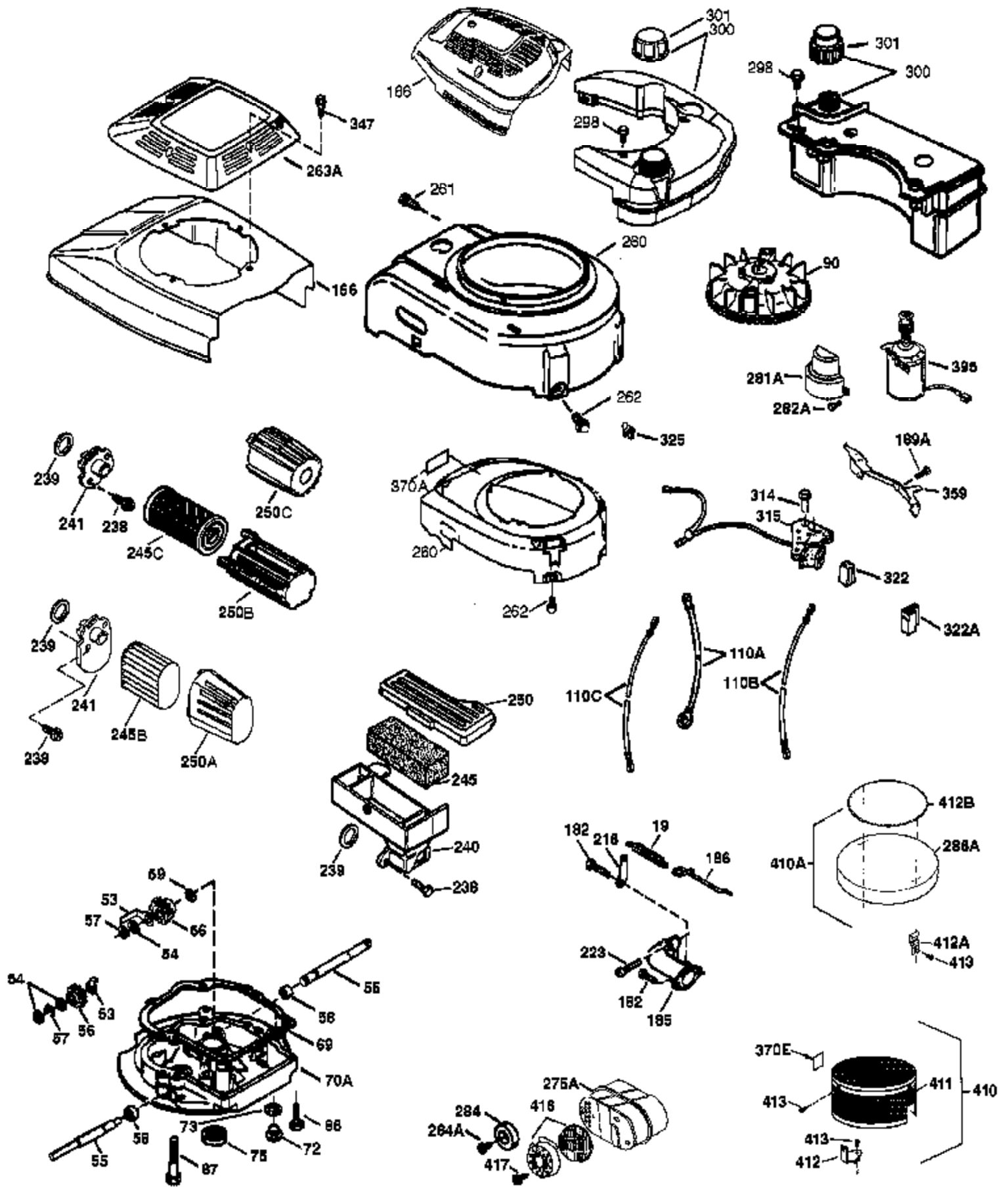

Ref #	Part Number	Qty	Description
19	36281	1	Extension Spring
41	40025	1	Piston & Pin Ass'y. (Std.) (Incl. 43)
41	40026	1	Piston & Pin Ass'y. (.010" OS)(Incl. 43)
69	37609	1	* Mounting Flange Gasket
72	37614	1	Oil Drain Plug
75	27897	1	Oil Seal
86	650488	6	Screw, 1/4-20 x 1-1/4"
90	611299	1	Flywheel
110A	37574	1	Ground Wire
182	6201	2	Screw, 1/4-28 x 7/8"
185	37466	1	Intake Pipe
186	34337	1	Governor Link
223	650451	1	Screw, 1/4-20 x 1"
238	650932	2	Screw, 10-32 x 49/64"
239	34338	1	* Air Cleaner Gasket
241	36919	1	Air Cleaner Collar
245	36905	1	Air Cleaner Filter
250	37122	1	Air Cleaner Cover
260	37848	1	Blower Housing
261	30200	2	Screw, 10-24 x 9/16"
262	650831	2	Screw, 1/4-20 x 1/2"
298	28763	3	Screw, 10-32 x 39/64"
300	34476A	1	Fuel Tank (Incl. 292 & 301)
301	33032	1	Fuel Cap Ass'y
355	590701	1	Starter Handle
361A	651075	1	Lock Nut, 10-24
416	37530	1	Spark Arrestor Kit (Incl. 417)(Optional)
417	650760	1	Screw, 8-32 x 3/8" (Optional)