

PART NO. 17048
Printed in U.S.A.
Price 35¢

parts list

HOMELITE®

XL-2S

Chain Saws

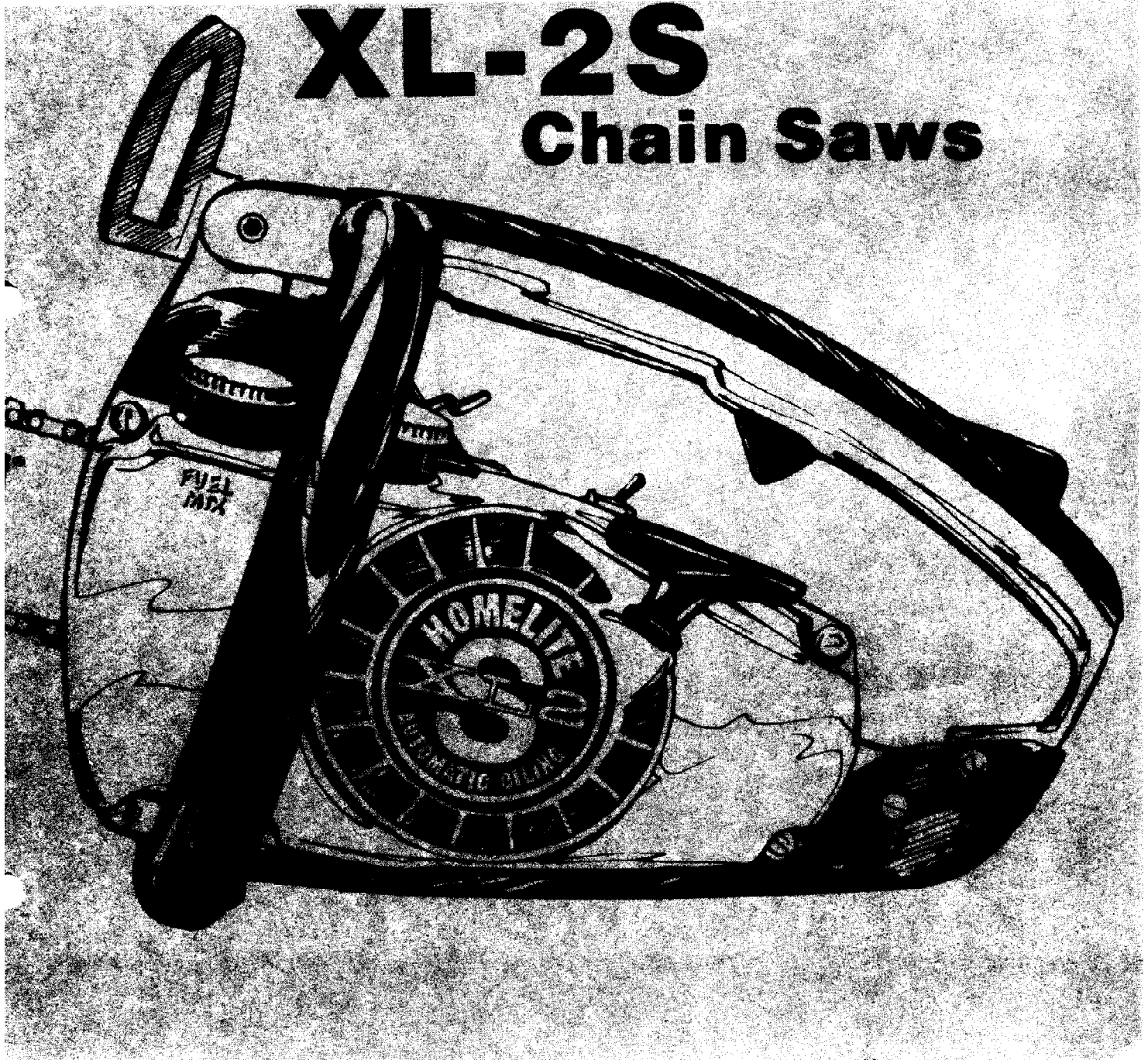

XL-2S

ACCESSORIES

GASKET- Oil pump body	69596
KIT- Spark arrestor (for A-69253-1 Muffler)	A-69586-B
Includes:	
SCREW- Self tapping (#6 x 1/4) (3)	80328
KIT- Hand guard	A-70796-A
Includes:	
SCREW	80312
SCREW- (10-32 x 5/8)	80572
WASHER- Belleville (2)	70728
SPACER	70748
TUBING- Rubber (10 ft.) (oil)	70309-99
TUBING- Rubber (10 ft.) (fuel)	70310-99

TOOLS

PULLER- Magneto rotor	A-24747-A
Includes:	
BOLT- 5/16-18 x 1 3/4	80288
NUT- Hex 5/16-18 (2)	81196
WRENCH- Hex soc. 5/32 (For 10-24 screw)	22126
WRENCH- Hex soc. 9/64 (For 8-32 screw)	23528
WRENCH- Spanner (Clutch)	A-93791
Includes:	
PIN	23717-A
WRENCH- Flat (for guide bar nut)	24814
DRIVE- Check valve (HDC carb. only)	24972
PLIERS- Tru-Arc	17198
GREASE- Multi-Use	94137

**XL-2S
FIGURE 1**

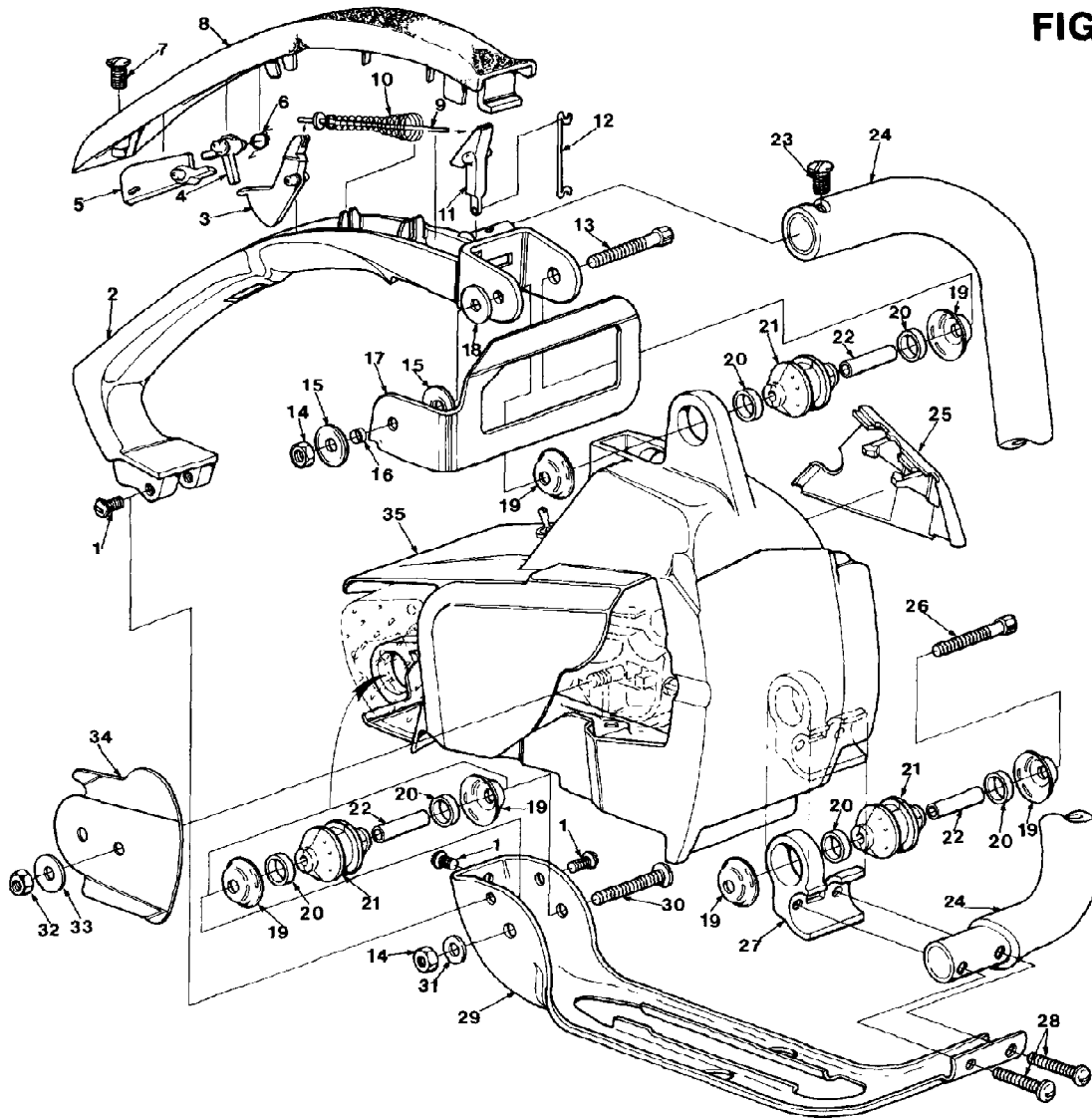

NO.	DESCRIPTION	PART NO.	QTY.	NO.	DESCRIPTION	PART NO.	QTY.
1	SCREW- Pan hd (8-32 x 3/8)	80577-2	3	20	RING- Isolator	70432	6
2	HANDLE- Throttle	70568-2	1	21	ISOLATOR- Vibration	70485-A	3
3	TRIGGER	70619	1	22	SPACER- Isolator	70433	3
4	STOP- Throttle safety	70593	1	23	SCREW- Pan washer hd (10-32 x 5/8)	82239	1
5	LEVER- Throttle safety	70594	1	24	HANDLE BAR	A-70804	1
6	SPRING- Torsion	70591	1	25	COVER- Air filter	70571	1
7	SCREW- Pan hd (10-32 x 5/8)	82239	1	26	SCREW- Cap hex soc (10-32 x 1 3/4)	82310	1
8	COVER- Handle	70626	1	27	BRACKET- Isolator mtg	70558-2	1
9	ROD- Throttle	A-70614	1	28	SCREW- Hex hd (10-32 x 1 3/16)	80841	2
10	SPRING- Throttle rod	69249	1	29	BRACE- Handle	70554-1	1
11	LEVER- Throttle	69107	1	30	SCREW- Pan hd (10-32 x 1 3/4")	82317	1
12	ROD- Throttle	70612	1	31	WASHER- Flat (10)	84008	1
13	SCREW- Cap hex soc , hd (10-32 x 2")	82321	1	32	NUT- Guide bar (1/4-28)	81065-2	1
14	NUT- Hex (10-32)	81206	2	33	WASHER- Flat	69309-1	1
15	WASHER- Belleville	70728	2	34	PLATE- Guide bar	69360	1
16	SPACER- Hand guard	70748	1	35	HOUSING- Engine	A-70662-B	1
17	GUARD- hand	70802-1	1		(see Fig 2 for breakdown)		
18	WASHER- Flat	70632	1				
19	WASHER- Isolator	70440-A	6				

ALWAYS FURNISH MODEL AND SERIAL NUMBER WHEN ORDERING PARTS

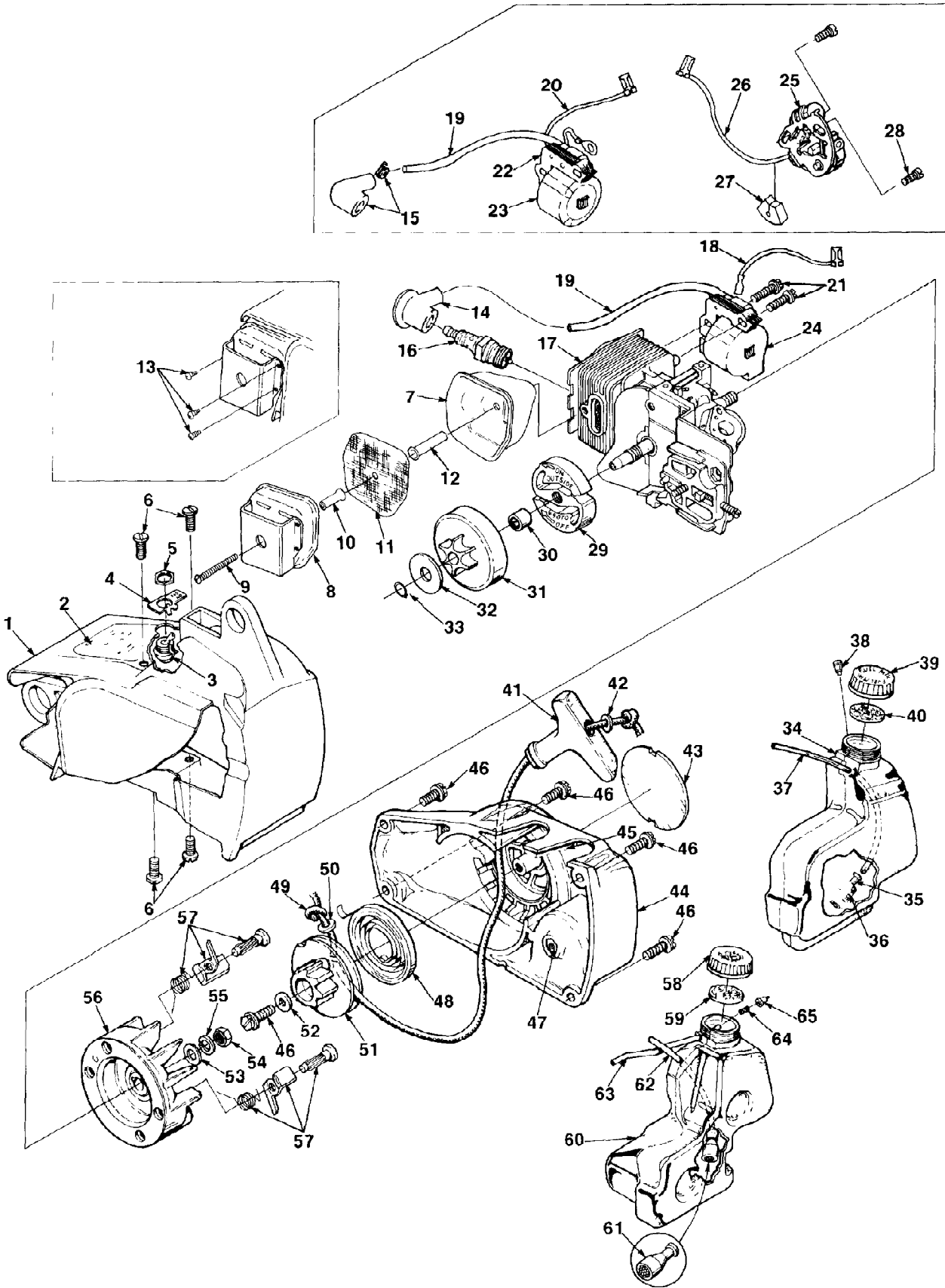

**XL-2S
FIGURE 2**

NO.	DESCRIPTION	PART NO.	QTY.	NO.	DESCRIPTION	PART NO.	QTY.
1	HOUSING- Engine Includes	A-70662-B	1	41	GRIP- Starter rope	70211	1
2	PLATE- Instructions	70835	1	42	WASHER- Flat	84025	1
3	SWITCH- Stop (grounding) Includes	A-63938	1	43	DECAL	70617	1
4	PLATE- "ON-OFF"	70834	1	44	HOUSING- Rewind starter Includes	A-70663	1
5	NUT- Hex	72084-A1	1	45	FILTER- Fuel tank valve	69443	2
6	SCREW- pan hd (10-24 x 1/2)	82216	4	46	SCREW- Hex washer hd (10-32 x 5/8)	80704	5
7	MUFFLER Includes	A-94051-B	1	47	NUT- Center locking hex (#10-32)	81206	1
8	CAP- Muffler	A-95428	1	48	SPRING- Rewind	69217	1
9	SCREW- (10-24 x 1 3/4) SPARK ARRESTOR Includes	82320 A-94139	1 1	49	ROPE- Starter (#4, 34" long) Includes	A-93874	1
10	SPACER	93989	1	50	WASHER- Nylon	93862	1
11	SCREEN- Spark arrestor	D-93991	1	51	PULLEY- Starter	69158	1
12	SPACER	93990	1	52	WASHER- Flat	63606	1
13	SCREW- #4 x 250 (Note 5)	82342	3	53	WASHER- Flat	84065-1	1
14	TERMINAL- Spark plug (Solid state) (Serviced with item #15)			54	NUT- Hex	81117	1
15	TERMINAL- Spark plug (Point ignition)	A-33055	1	55	WASHER- Lock	83002	1
16	SPARK PLUG- Champion DJ-7J	68616-S	1	56	ROTOR & STARTER PAWL (Solid state) ROTOR & STARTER PAWL (Point ignition)	A-94717 A-69297-A	1 1
17	CYLINDER & CRANKCASE (Solid state) CYLINDER & CRANKCASE (Point ignition) (See Fig 3 for breakdown)	A-95071 A-69421-B	1 1	57	KIT- Starter pawl (See Note 4)	A-70285-A	2
18	LEAD- Ground (Solid state)	A-94721	1	58	CAP- Tank oil Includes	A-70893-A	1
19	LEAD- High tension (See Note 1)	69326	1	59	GASKET- Fuel filler cap (See Note 3)	94838	1
20	LEAD- Ground (Point ignition)	A-95051	1	60	TANK- Oil Includes	A-70583	1
21	SCREW- Hex w/washer (8-32 x 3/4)	82248	2	61	FILTER- Oil	A-68593	1
22	CORE- Coil (Point ignition)	69324	1	62	TUBING- Rubber	70309-24	1
23	COIL- Ignition (Point ignition) RETAINER- Coil (Not Shown) (Point ignition)	69323 69325	1 1	63	LINE- Pressure Includes	A-69358	1
24	MODULE- Ignition (Solid state)	A-94711	1	64	CONNECTOR- Oil line	69659-1A	1
25	POINT SET- Breaker (Point ignition) Includes	A-69336	1	65	VALVE- Check (Duckbill)	69451	1
26	LEAD- Electrical (Point ignition)	70249	1				
27	SEAL- Lead (Point ignition)	69247	1				
28	SCREW- Fil hd , (6-32 x 3/8) (Point ignition)	88026	2	NOTE 1	For Solid State Ignition cut wire to 6 1/2"		
29	CLUTCH- "S" (See Note 2)	A-70351-A	1	NOTE 2	Retaining Ring, item 33, must never be reused once it has been removed. Item 33 is included with both item 29 and 31		
30	BEARING- Clutch Drum	68512	1	NOTE 3	Use 70826 Gasket in A-70893 and A-70894 external thread caps. Use 69585 Gasket for caps with internal threads		
31	SPROCKET & DRUM	A-70221-C	1	NOTE 4	Replacement Starter Pawl Kit, item #57 includes an over sized pin. Paint, stamp or mark to identify over-sized pin when installing. Oversize pin can be installed tightly only once. If over sized pin is removed, the entire rotor assembly must be replaced		
32	WASHER- Thrust (Clutch)	69138	1	NOTE 5	Units with separate shield requires index #13 screw. All new muffler cap A-95428 includes a shield welded to cap		
33	RING- Retaining (See Note 2)	93972	1				
34	TANK- Fuel Includes	A-70582	1				
35	FILTER- Fuel Includes	A-69923	1				
36	ELEMENT- Felt	64083	1				
37	TUBING- Rubber	70310-29	1				
38	VALVE- Check (Duckbill)	69451	1				
39	CAP- Fuel (Red) Includes	A-70894-A	1				
40	GASKET- Filler cap (See Note 3)	94838	1				

XL-2S
FIGURE 3

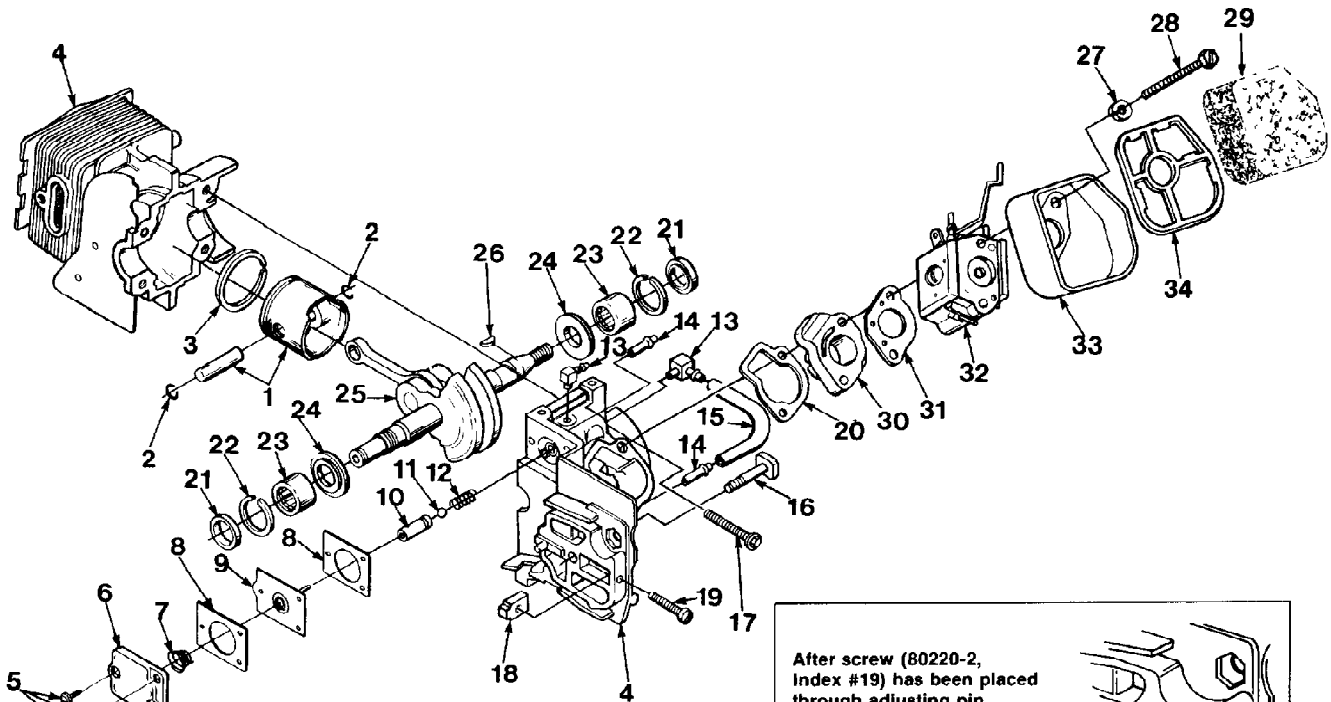

After screw (80220-2, Index #19) has been placed through adjusting pin (69254-1A, Index #18) the end of the screw should be crimped. This will prevent the screw from backing out.

NO.	DESCRIPTION	PART NO.	QTY.	NO.	DESCRIPTION	PART NO.	QTY.
1	PISTON & PIN Includes	A-69393	1	15	LINE- Oil	70161	1
2	RING- Piston retaining	65261	2	16	BOLT- Guide bar	69195	1
3	PISTON RING	69312	1	17	SCREW- Sem hex hd , 8-32 x 1	88044	4
4	CRANKCASE & CYLINDER (Solid state)	A-95071	1	18	PIN- Adjusting	69254-1A	1
	CRANKCASE & CYLINDER (Point ignition)	A-69421-B	1	19	SCREW- Adjusting fil hd 8-32 x 1	80220-2	1
	Includes			20	GASKET- Intake manifold	69143	1
	SCREW- Tapping pan (Not Shown)	93932	1	21	SEAL	94638	2
5	SCREW- Pan hd , 6-32 x 3/8	80571	3	22	SPACER- Seal	69407	2
6	COVER- Oil pump	69224-1C	1	23	BEARING- Needle	12530	2
7	SPRING- Oil pump	69447	1	24	WASHER- Thrust	69093-A	2
8	GASKET- Oil pump	69244-1	2	25	CRANKSHAFT- (Solid state)	A-94712	1
9	PLUNGER- Oil pump	A-12356-B	1		CRANKSHAFT- (Point ignition)	A-70352	1
10	BODY- Oil pump	69343-1	1	26	KEY- Magneto (See insert)	69250	1
11	BALL- Check valve	60051	1	27	WASHER- Lock #10	83006-1	2
12	SPRING- Check valve	68570	1	28	SCREW- Hex hd (10-32 x 2 1/4)	80481	2
13	FITTING- Oil line	70204	2	29	ELEMENT- Air filter	70566	1
14	FITTING- Tube	69833	2	30	MANIFOLD- Intake	A-69373-A	1
				31	GASKET- Carburetor	65016	1
				32	CARBURETOR- (HDC-49)	A-94054	1
				33	CUP- Air filter	70557	1
				34	RETAINER- Air filter	70556	1

XL-2S

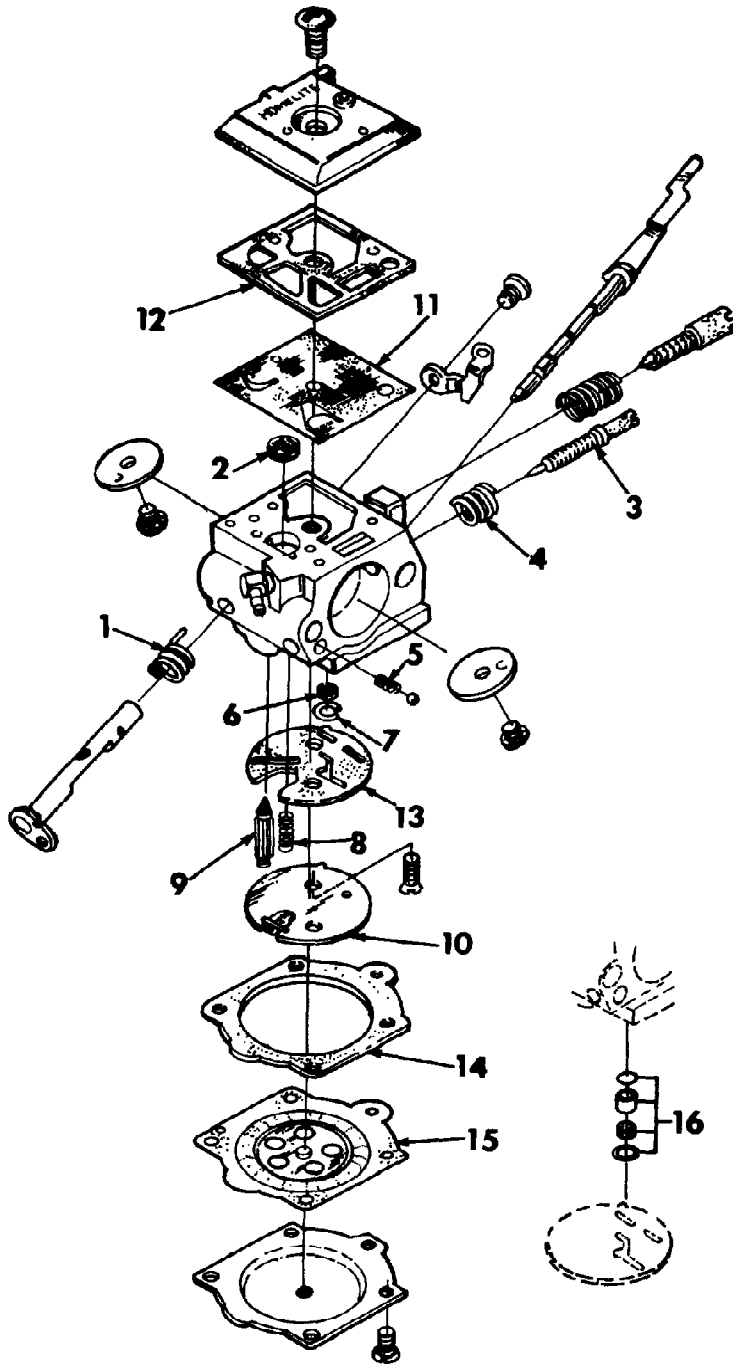

CARBURETOR

A-94054

HDC-49

- 94061-A REPAIR KIT (Includes: 1-15)
- 70655 GASKET/DIAPHRAGM KIT (Includes: 11-15)
- 93901 CHECK VALVE REPAIR KIT (#16)
- 94057 CIRCUIT PLATE- High altitude .029 (Not shown)
- 64229 INLET NEEDLE (#9)

ALWAYS FURNISH MODEL AND SERIAL NUMBER WHEN ORDERING PARTS.

0086JY



HOMELITE DIVISION OF TEXTRON
P O Box 7047
14401 Carowinds Boulevard
Charlotte, N C. 28217

HOMELITE **TEXTRON**

Homelite Division of Textron Inc