

Ref #	Part Number	Qty	S/P/F	Description
	A03904	1	/P	Gasket/Diaphragm Kit Included items 1 - 4
	A01375	1		Repair Kit Included items 1 - 10
1		1		Superseded by UP07217 Included in Repair Kit P/N A03904 & Gasket/Diaphragm Kit P/N A01375
2		1		Superseded by UP07217 Included in Repair Kit P/N A03904 & Gasket/Diaphragm Kit P/N A01375
3		1		Superseded by UP07217 Included in Repair Kit P/N A03904 & Gasket/Diaphragm Kit P/N A01375
4		1		Superseded by UP07217 Included in Repair Kit P/N A03904 & Gasket/Diaphragm Kit P/N A01375
5		1		Superseded by UP07217 Included in Repair Kit P/N A03904
6		1		Superseded by UP07217 Included in Repair Kit P/N A03904
7		1		Superseded by UP07217 Included in Repair Kit P/N A03904
8		1		Superseded by UP07217 Included in Repair Kit P/N A03904
9		1		Superseded by UP07217 Included in Repair Kit P/N A03904
10		1		Superseded by UP07217 Included in Repair Kit P/N A03904



XL Chain Saw UT-10722-B
Engine Housing

Page 4 of 12

Ref #	Part Number	Qty	S/P/F	Description
1	94065	2		SCREW-Pan, plastite (#10-16 X 3/4")
2	02495	1		COVER-Handle
3	02493	1		LOCK-Trigger
4	02492A	1		TRIGGER
5	02501	1	/P	ROD-Throttle
6	A02482	1	S	LEAD-w/Flag Term.
7	A02434	1		LEAD-w/Ring Term.
8	02491	1		SWITCH
9	A01147	1		OIL VALVE
10	7031017	1	S	TUBING-Rubber (4 1/4")
11	82528	5	/P	SCREW-Pan plastite (#6 X 3/8")
12	02765	1		SHIELD-Muffler
13	A01232	1	S	HOUSING-Engine
14	95615	2	S/P	TAPE
15	02490A	1		DECAL-Warning
16	82538	4	/P	SCREW-Torx, taptite (10-24 X 3/4")
17	95212	1	/P	STOP-Chain
18	82563	1	/P	SCREW-Torx, plastite (#10 X 3/4")
19	69360A	1		PLATE-Guide Bar
20	69309A	1	/P	WASHER-Flat
21	810652	1	S	NUT-Hex
22	7031032	1	S	TUBING Rubber (8")
23	02481	1		COVER- Air Filter

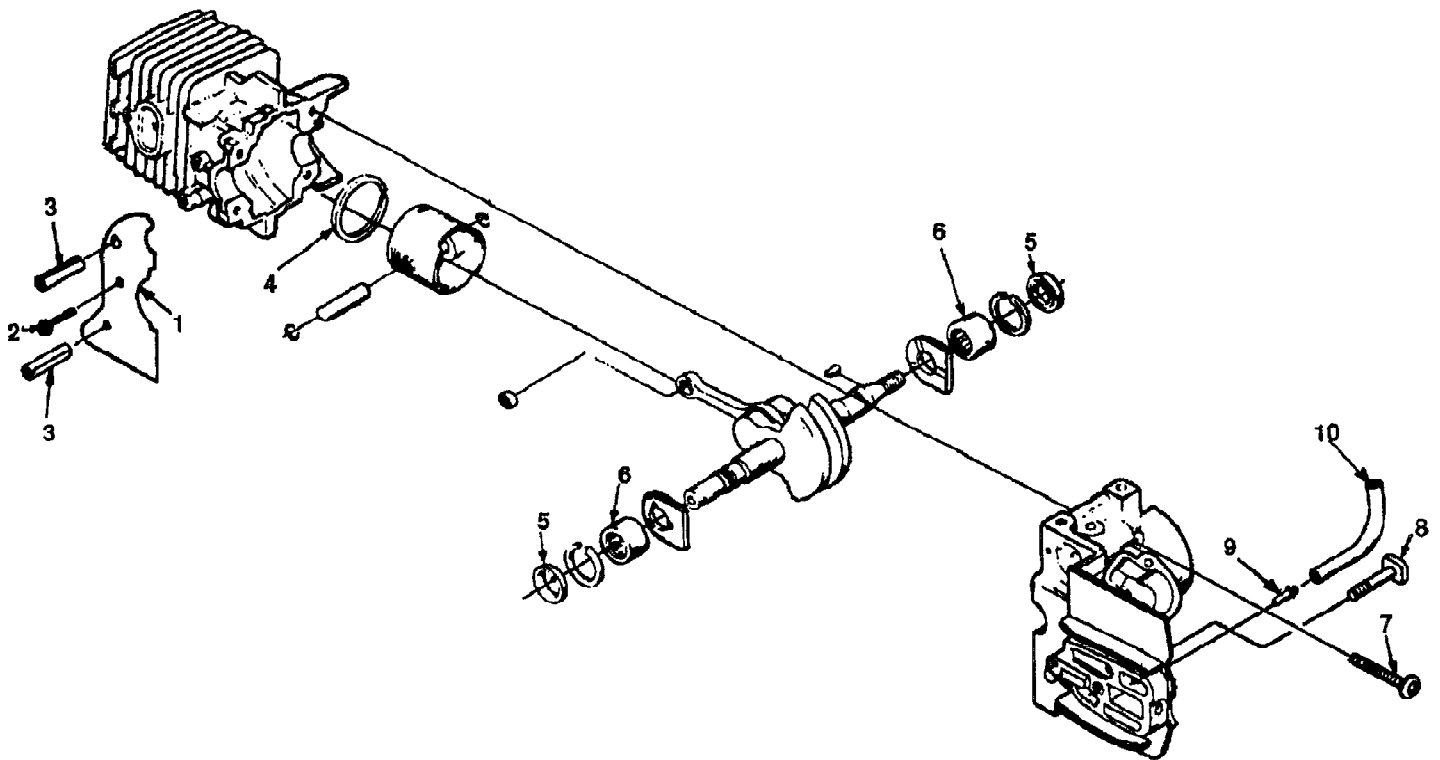

Ref #	Part Number	Qty	S/P/F	Description
1	02639	1	/P	SAW DUST SHIELD
2	93932	1		SCREW- Tapping (#6-32 x 5/16")
3	70763	2	/P	PIN- Roll (5/32 x 1 1/8") (Brake Model Only)
	A001321	1	S	SHORT BLOCK (XL, 180)
4	93165	1		RING- Piston
5	94638	2	S	SEAL- Shaft
6	12530	2		BEARING- Needle
7	82567	4		SCREW- Torx Pan Hd. (10-24 x 1 1/8")
8	69195	1	/P	BOLT-Guide Bar
9	94619	1		FITTING- Tube
	A01105	1	S	SHORT BLOCK (192, Super 2, 200, Super 2 SL))
	93165	1		RING-Piston
	94638	2	S	SEAL- Shaft
	12530	2		BEARING- Needle
	82567	4		SCREW- Torx Pan Hd. (10-24 x 1 1/8")
	69195	1	/P	BOLT- Guide Bar
	94619	1		FITTING- Tube
10	7031017	1	S	TUBING- Rubber (Oil Line) (4 1/4")
	7031099	1	S	TUBING- Rubber (Oil Line) (10 Ft. Length)

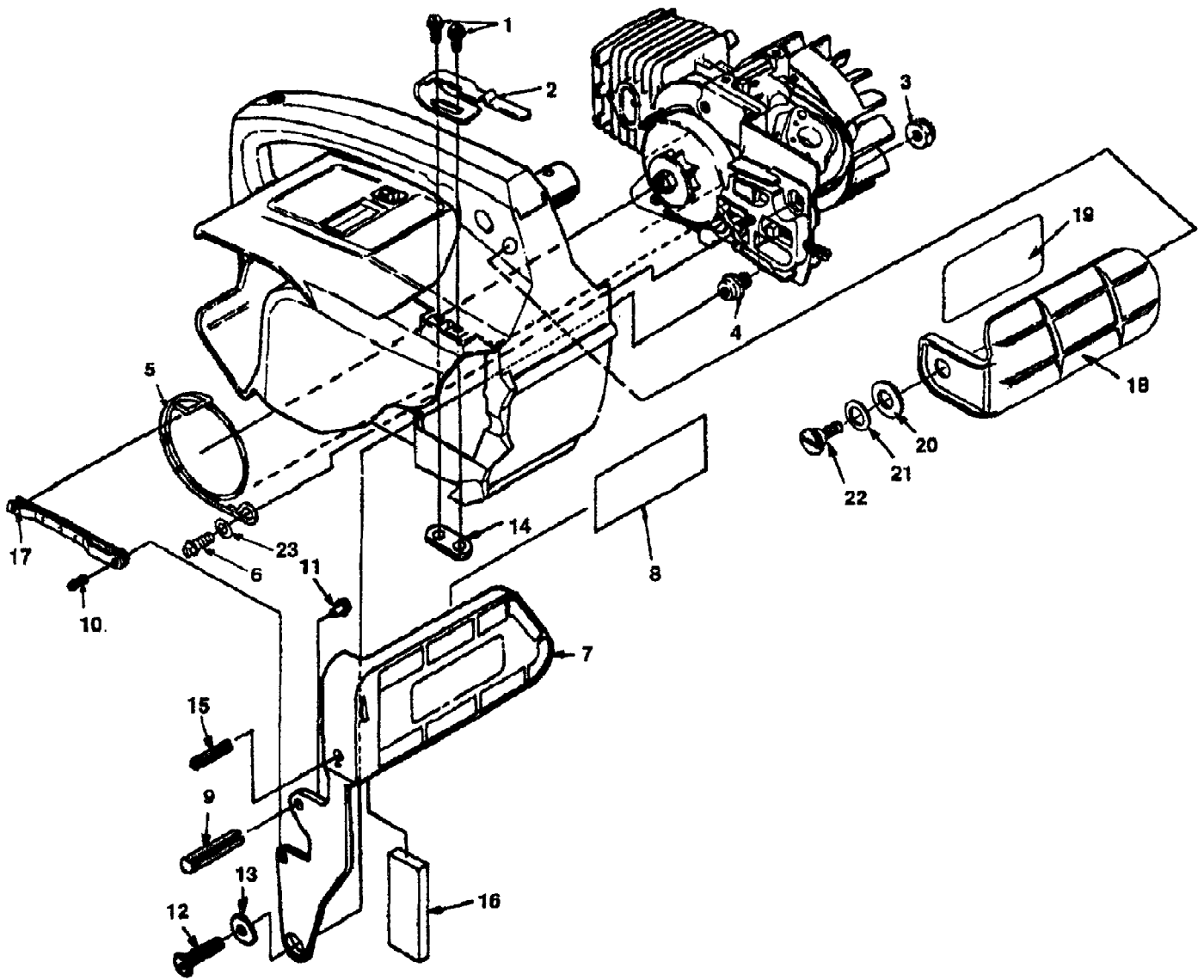

XL Chain Saw UT-10722-B
Handguard & Chain Brake

Page 8 of 12

Ref #	Part Number	Qty	S/P/F	Description
1	88066	2	S	SCREW-Hex Hd. w/Washer (8-32 X 1/2")
2	02635	1		CLIP-Retaining
3	81124A	1	/P	NUT-Hex, Jam
4	70636	1		POST-Chain Brake
5	70637C	1	S	BAND-Brake
6	82538	1	/P	SCREW-Thread Form (10-24 x 3/4")
7	A03061A	1		HANDGUARD & LEVER (200, Super 2 SL)
8	02661	1		DECAL-Safety
9	JA461383	1		PIN-Roll (3/16 X 1")
10	95395A	1	/P	PIN-Roll
11	82367	1	/P	SCREW-Drive
12	82166	1		SCREW-Machine, Pan Hd. (10-32 X 1/2")
13	70632	1	/P	WASHER-Flat
14	02637	1		NUT-Weld
15	JA461361	1		PIN-Roll
16	02462	1		WEIGHT-Handle (International Only)
17	A70767	1		PIVOT-Link
18	A70796C	1	S	HANDGUARD KIT (Super 2, XL, 180 & 192)
19	02661	1		DECAL-Handguard
20	95694	1		WASHER-Curve Spring
21	96102	1		WASHER-Flat
22	95714	1	S	SCREW-Shoulder
23	84008	1	S/P	WASHER- Flat (#10)



OULET OIL FITTING
TO GUIDE BAR PAD
FITTING. 4" LONG.
70310-17

PRESSURE PULSE LINE
FROM CARBURETOR
BRASS ELBOW TO
DUCK BILL IN OIL TANK
4 3/4" LONG.
70310-19

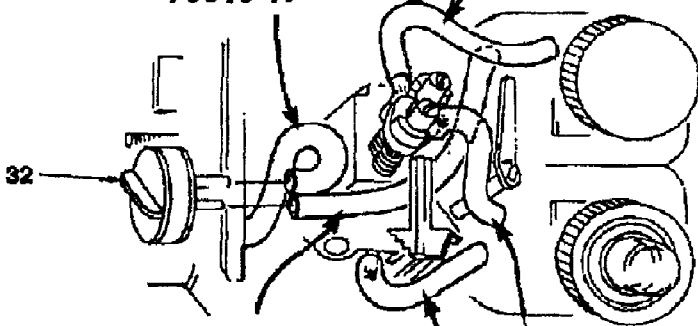

FROM OIL PICK UP
TO CENTRAL VALVE
FITTING. 8" OVERALL
LENGTH WITH 4 1/2"
OUT OF TANK.
70310-32

FUEL INLET LINE
FROM PICK UP
TO FITTING ON
BOTTOM OF
CARBURETOR. 5 1/2"
LONG OVERALL
AND 1 3/4" OUT
OF TANK.
70310-22

PRIMER INLET LINE
FROM CARBURETOR
FITTING UNDER
ADJUSTING SCREWS
TO PRIMER FITTING.
6 1/4" LONG, W/2 1/2"
OUT OF TANK.
70310-25

XL Chain Saw UT-10722-B
Intake, Ignition, Muffler & Clutch

Page 10 of 12

Ref #	Part Number	Qty	S/P/F	Description
1	93460	1	/P	SCREW-Machine Hex Sems (#8 -32 X 3/4")
2	A02459	1		MUFFLER
3	02458	1		SCREEN-Spark Arrestor
4	02500	1	S	FILTER-Air
5	00167	2	/P	SCREW-Thread Forming
6	02491A	1		BOX-Air Filter
7	A01373	1		CARBURETOR (Zama)
8	02488	1	S	GASKET-Carburetor
9	82589	2	/P	SCREW-Plastite, (10-14 X 1")
10	A02499	1		HEAT DAM
11	95983	1	S	REED
12	03205	1		STOP-Reed
13	82498	2	/P	SCREW-Hex Taptite (4-40 X 3/8")
14	02453	1	/P	GASKET-Intake Manifold
15	82540	2	/P	SCREW-Thread Forming (8-32 X 1")
16	94711CS	1	/P	MODULE-Ignition
17	A33055	1	/P	TERMINAL
18	96169S	1	S	SPARK PLUG (Champion DJ7Y)
	79252	1	S	SPARK PLUG (Champion RDJ7Y)
19	03961	3		SPRING-Clutch
20	79221	1	/P	SPIDER-Clutch
21	79222A	3		SHOE-Clutch
22	A95653C	1	S	SPROCKET & DRUM
23	70277	1	S	BEARING
24	81229	2		NUT-Rotor (5/16-24)
25	95299	2	/P	WASHER-Thrust
26	692542	1	/P	PIN-Adjusting
27	A00440	1	/P	SCREW & E-RING KIT
28	93574	1	S	E-RING
29	A04158	1	S	ROTOR & STARTER PAWL
30	A70285E	1	/P	STARTER PAWL KIT
31	84065	1	S	WASHER-(5/16")
32	A01147	1		OIL VALVE

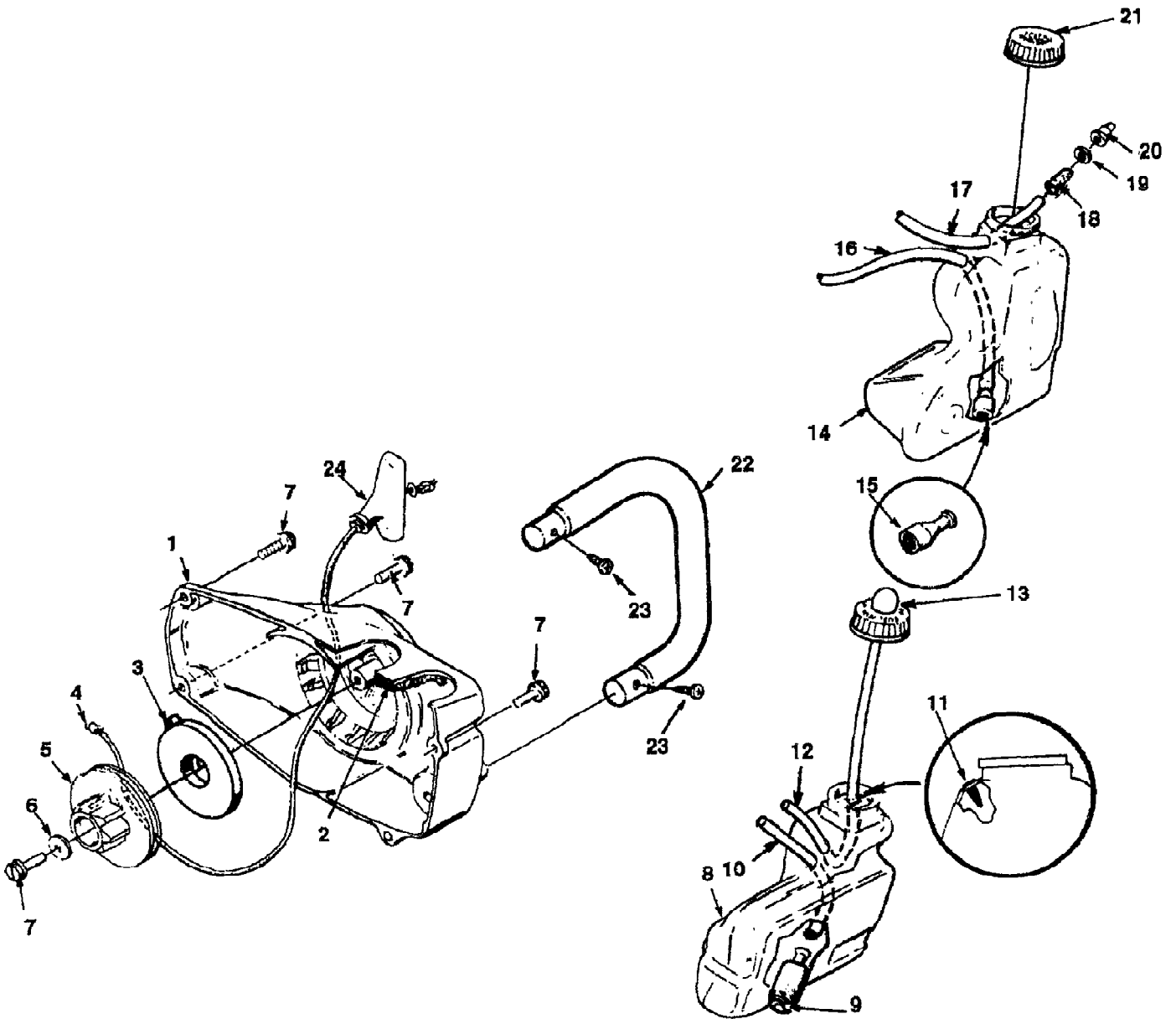

XL Chain Saw UT-10722-B
Starter & Tanks

Page 12 of 12

Ref #	Part Number	Qty	S/P/F	Description
1	A02562B	1	S	STARTER HOUSING ASSY.
2	69443	1		FILTER
3	A97908	1	/P	SPRING & CONTAINER
4	9789901	1	/P	ROPE-Starter (46")
	98052A	1	/P	ROPE- Starter (250 Ft. Reel)
5	97768A	1		PULLEY Starter
6	94062	1	/P	WASHER-Retaining
7	82563	5	/P	SCREW-Torx (#10 x 3/4")
8	A027641	1		FUEL TANK
9	49422	1	S	FILTER- Fuel
10	7031022	1	S	LINE-Fuel (5 1/2")
11	08819	1		VALVE-Check
12	7031025	1	S	TUBING-Return 6 1/4"
	7031099	1	S	TUBING- Rubber (10 Ft. Length)
13	A01372A	1	/P	PRIMER & CAP
14	A027631	1		OIL TANK
15	A68593	1		FINDER-Oil
16	7031032	1	S	TUBING-Rubber (8")
17	7031019	1	S	TUBING-Rubber (4 3/4")
18	69659B	1		FITTING-Oil
19	83004	1	S	WASHER- Lock
20	98819	1	/P	VALVE-Check
21	A97230A	1		OIL CAP
22	02496	1	S	HANDLE BAR
23	94065	2		SCREW- Pan Plastite (#10-16 x 3/4")
24	02264	1	S	GRIP-Starter