

SXLAO Chain Saw UT-10489-A
Carburetor Chamber

Page 2 of 21

Ref #	Part Number	Qty	S/P/F	Description
1	59274	1		GASKET- Spacer
2	59718	1		SPACER
3	63260A	1	S	RETAINER- Reed valve
4	63253	1		SEAT- Reed valve
5	59678B	4	S	VALVE- Reed
6	59722	1		GASKET- Carburetor
7	7031037	1	F	LINE- Fuel 9 1/4"
8	A68371B	1		CARBURETOR- Walbro (SDC-62)
	A68363BS	1	/P	CARBURETOR- Tillotson (HS-179-B)
	A94953	1		CARBURETOR- Zama (#20-20)
9	68279	1		GROMMET
10	86324	1	/P	PIN- Cotter
11	5877312	1	S	COVER-Air filter
12	A65272	1	S	NUT- Air filter cover
13	58319A	1	/P	RING- Retaining
14	63589A	1	S/P	ELEMENT- Air filter
15	A59822B	1	/P	BRACKET- Mounting
16	681301	1		ROD- Choke
17	58362	1		GROMMET
18	59763	1		ROD- Throttle
19	80891	5	/P	SCREW- Hex 12-24 x 7/8
20	83046	2		WASHER- Lock #10
21	80921	2		SCREW- Hex 10-32 x 2 11/16
22	95671	1	S	PIN- Throttle latch
23	58405	1		SPRING- Throttle latch
24	A592131A	1	S	COVER- Throttle handle
	67752	1		Bushing- Pin (Not shown)
25	80560	2	/P	SCREW- Pan 8-32 x 1/2
26	58859	1	S	TRIGGER- Throttle
27	58409	1	/P	RING- Retaining
28	A93926	1		THROTTLE HANDLE
29	63290	1		WASHER- Felt
30	86301	1		PIN- Cotter
31	67634	1		BOOT- Throttle rod
32	63303	1		PLUG
33	93209	1	S	SHIELD- Spark plug
34	94142	1		PIN
35	A59011	1		VALVE- Check
36	63302B	1	/P	SCREW- Idle
37	59770	1	S	GROMMET- Hi-Lo
38	A93783	1	S	PLUNGER- Spring
39	59293	1	/P	SPRING- Compression
40	74388	1	S	"O" RING
41	A59818	1		VALVE- Check
42	96479	1		LABEL- Homelite

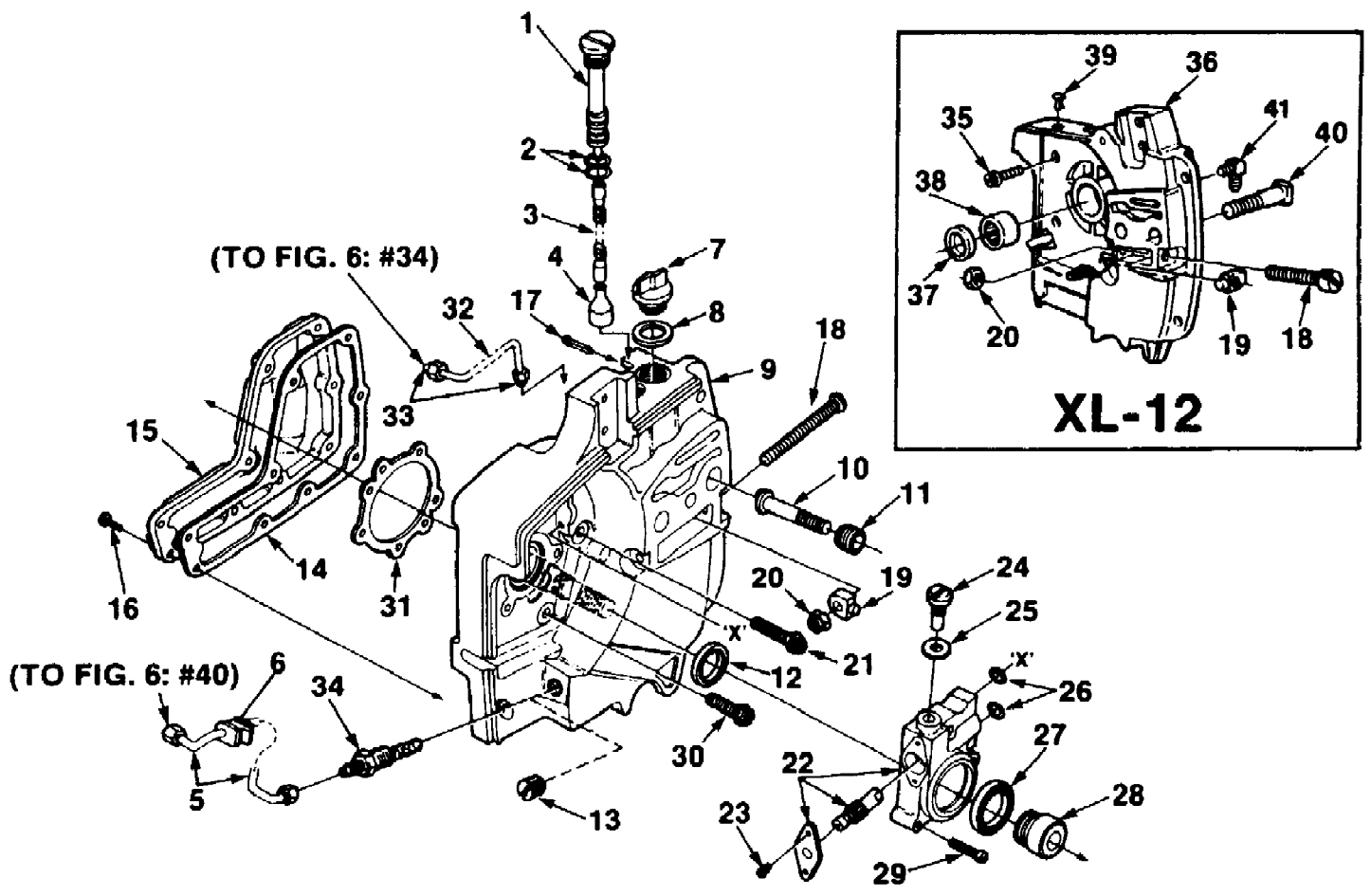

SXLAO Chain Saw UT-10489-A
Drive Case & Oil Pump

Page 4 of 21

Ref #	Part Number	Qty	S/P/F	Description
	A69371	1	S	OIL FILTER ASSEMBLY
1	593252	1	/P	TUBE- Oil line
2	59765	2		"O" RING
3	7030909	1	S	TUBING- Rubber 2 1/4"
4	A68593	1		FILTER- Oil
5	A59819	1		LINE- Oil
6	59794	1		GROMMET
7	A63717C	1	/P	CAP- Filler oil
8	56607	1	/P	GASKET
9	A59930H	1	S	DRIVECASE
10	67475	2		STUD- Guide bar, 3/8
11	67476	2		INSERT- Threaded
12	58308B	1	S	SEAL
13	28097	1		PLUG
14	59710	1		GASKET- Oil reservoir
15	596494A	1		COVER- Oil reservoir
16	80513	9		SCREW- Rd. 6-32 x 1/2
	80742	1		SCREW- Set (not shown)
17	86301	1		PIN- Cotter
18	63225	1	/P	SCREW- Guide bar adjusting
19	93039	1	/P	PIN- Bar adjusting
20	81204	1	/P	NUT- Lock, 1/4-20
21	80864	1	/P	SCREW- Hex 12-24 x 1
22	A59809B	1		PUMP- Automatic oil
23	80919	2		SCREW- Pan 4-40 x 1/4
24	64102A	1		SCREW- Cam
25	59736	1		GASKET
26	59074	2	/P	"O" RING
27	59926	1	S	SEAL- Felt
28	59675	1		WORM
29	80248	3		SCREW- Fil. 8-32 x 3/4
30	80899	4		SCREW- Hex 12-24 x 9/16
31	63355	1	S	GASKET- Crankcase
32	A59806	1	S	LINE- Oil (Discharge)
33	25301	2		SLEEVE- Compression
34	A59804A	1		FILTER- Oil (Manual oil)

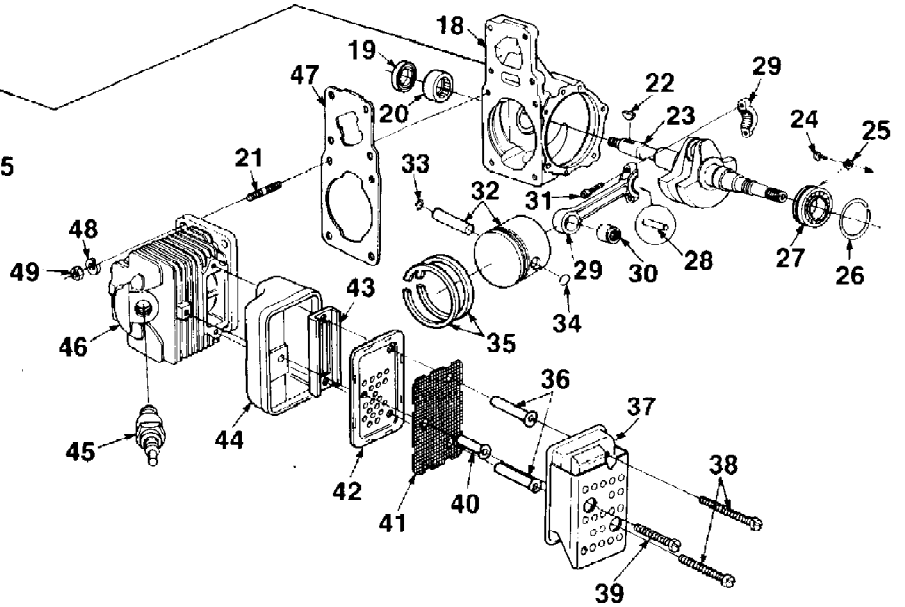
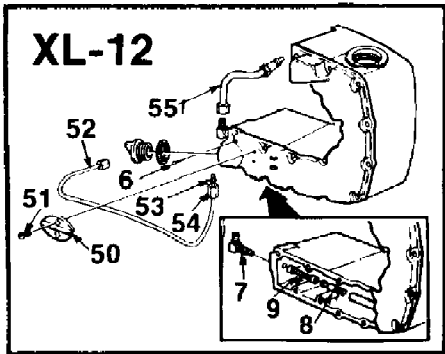
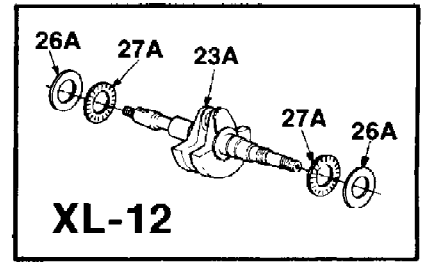
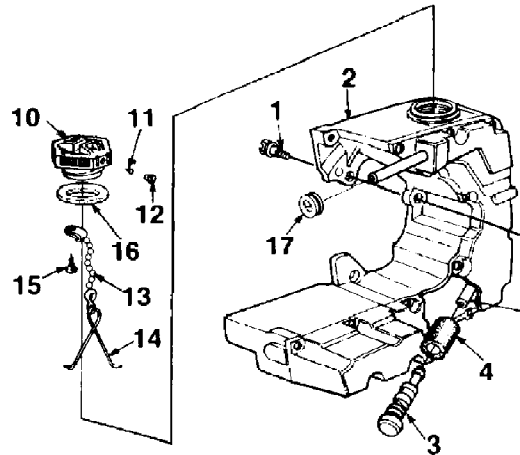

Ref #	Part Number	Qty	S/P/F	Description
1	63407	3	/P	SCREW- Shoulder
2	A68345A	1	S/F	TANK- Fuel
3	A69923	1	S	FILTER- Fuel
4	64083	1		FELT- Filter
5	7031037	1		TUBING- Fuel 9 1/4"
10	A69500A	1	S	CAP- Fuel filler
11	69451	1	/P	VALVE- Check
12	69454	1	/P	FILTER- Fuel cap
13	69502	1		CHAIN- Bead
14	96535	1	/P	RETAINER
15	82256A	1	/P	SCREW- Pan hd. #6 x 1/4
16	69501	1	/P	GASKET- Fuel filler cap
17	68046	1		GROMMET
18	A65736	1	/P	CRANKCASE
19	12282A	1	S	SEAL
20	58956	1	/P	BEARING
21	55871	4	S	STUD
22	75078	1		KEY- Woodruff
23	634981	1	/P	CRANKSHAFT
24	70306	2		SCREW- Torx
25	59705	2		WASHER- Lock
26	58319A	2	/P	RING- Retaining
27	58190	2	/P	BEARING- Ball
28	A69054	1		ROLLER SET (31)
29	A63477B	1	/P	ROD- Connecting
30	93369	1		BEARING
31	69919	2	/P	SCREW- Cap soc. hd.
32	A68438	1	S	PISTON & PIN
33	75120	1	/P	RING- Retaining
34	64813	1	/P	RING- Retaining
35	594361A	2	S	PISTON RING
	A94219A	1	F	MUFFLER ASSEMBLY
36	9398301	2		SPACER- Muffler
37	A95988	1	/P	CAP- Muffler & Shield
38	94128	2		SCREW- Hex hd. (12-24 x 2 1/4)
39	94129	1		SCREW- Hex hd. (12-24 x 1 7/8)
40	9398302	1		SPACER- Muffler
41	93979	1		SCREEN- Spark arrestor
42	93980	1		BAFFLE- Muffler
43	94133A	1		PLATE- Muffler
44	93981	1		BODY- Muffler
45	63547S	1	/P	SPARK PLUG (CJ6)
46	A69714	1	S	CYLINDER
47	59771	1		GASKET- Cylinder
48	83061	4	/P	WASHER- Lock 1/4
49	96212	4	/P	NUT- 1/4-28

SXLAO Chain Saw UT-10489-A
Handles & Clutch

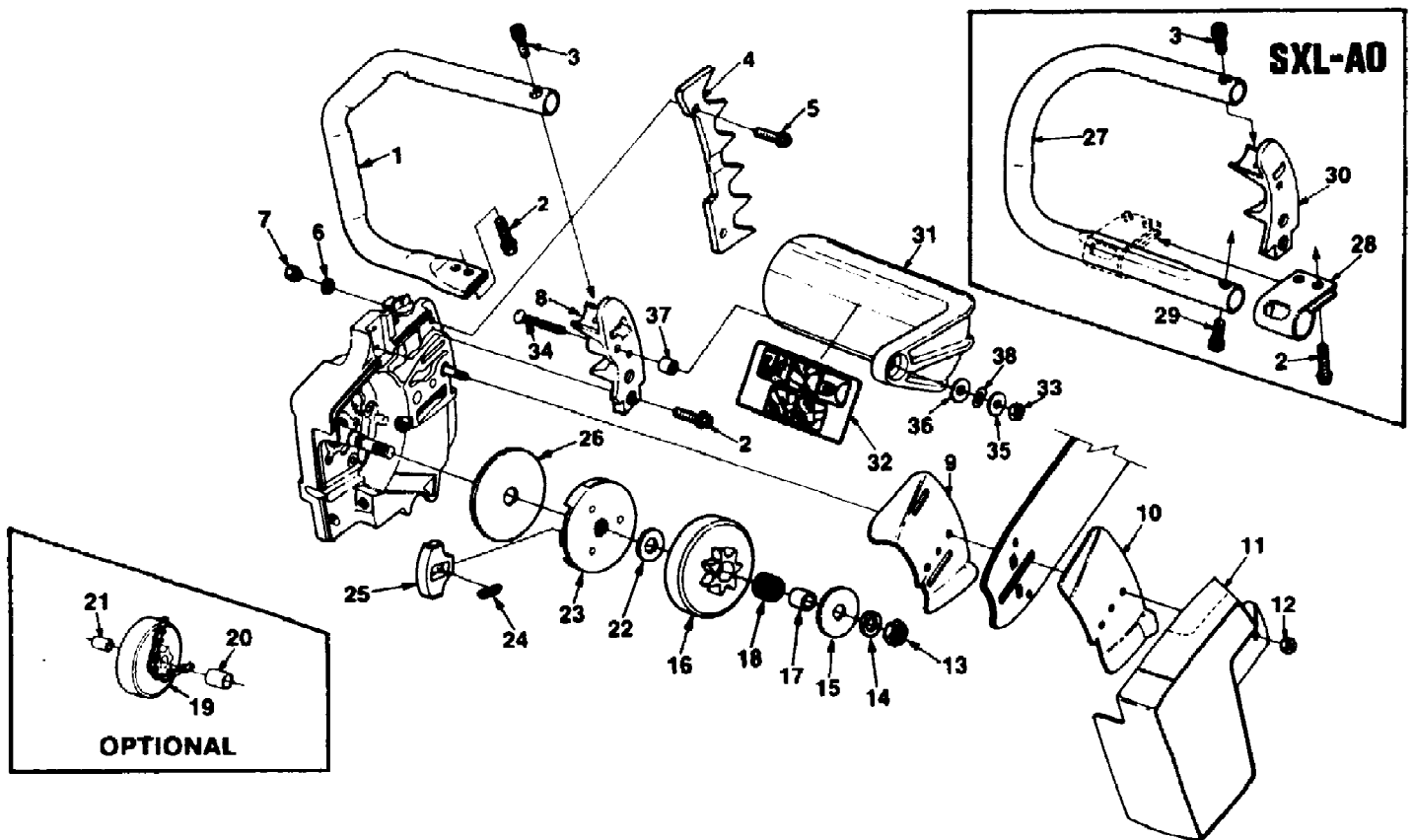

Ref #	Part Number	Qty	S/P/F	Description
2	80867	4	/P	SCREW- 12-24 x 3/4
3	804281	1	S	SCREW- Socket hd. 1/4-20 x 1
4	DA59043	1		BUMPER KIT- Spiked (Accessory)
5	80867	2	/P	SCREW- Hex 12-24 x 3/4
6	70901	2	/P	WASHER- Lock #12
7	81068	2	/P	NUT- Hex 12-24
8	A70618	1	/P	KIT- Guide bar plate
9	70399	1	S	PLATE- Guide bar (inner)
10	70400	1	S	PLATE- Guide bar (outer)
11	5875016	1	S	COVER- Drivecase
12	810892	2	/P	NUT- Hex 3/8-16
13	81124	1	S	NUT- Lock 3/8-24
14	83018	1	/P	WASHER- Lock 3/8
15	65064	1		WASHER- Thrust (outer)
16	A95459	1	F	SPROCKET & DRUM 7 tooth (std.) 3/8,7 tooth
17	65746B	1	S	RACE- Inner
18	64124	1	S	BEARING- Roller
19	A63346	1		SPROCKET & DRUM (opt.) 3/8" pitch, 8T
	A59555	1		.404 pitch, 7 T
20	72311	1	F	BEARING- Needle
21	55584	1	F	RACE- Inner
	A65990	1		HUB & DRUM- "splined" (opt.) (used w/ index #17,18,22 & rim sprockets
	95058	1	F	SPROCKET- Splined rim typed 3/8" 7 T
	63285	1		.404 pitch, 7 tooth Check type and number of teeth before ordering. "Splined" hub and drum requires one of the "Splined" Sprockets listed
22	58833	1	/P	WASHER- Thrust (inner)
	A69480C	1	/P	CLUTCH & COVER
23	657601B	1	/P	PLATE- Clutch
24	67053	3		SPRING- Clutch
25	69461	3		SHOE- Clutch
26	95054	1	S	COVER- Clutch
27	A70365	1		HANDLE BAR- Flush cut
28	63291A	1	S	CLAMP
29	804281	1	S	SCREW- Soc. hd. 1/4-20
30	5965112	1	F	BRACKET- Handle bar
	A63422A	1		HANDLE BAR- Wrap around
	A63421	1		HANDLE BAR
	596516B	1		BRACKET- Handle bar
	63405	1		BRACKET- Handle bar mtg.
	80676	1	/P	SCREW- Hex hd. 12-24 x 5/8
31	A95088	1		GUARD- Hand
32	96990	1		DECAL
33	81225	1	/P	NUT- 12/24
34	82223	4		SCREW- (12-24 x 1 1/4)
35	95935	1	/P	WASHER (5/16)
36	84065	1	S	WASHER
37	95937	1		SPACER
38	96757	1		WASHER- Spring wave

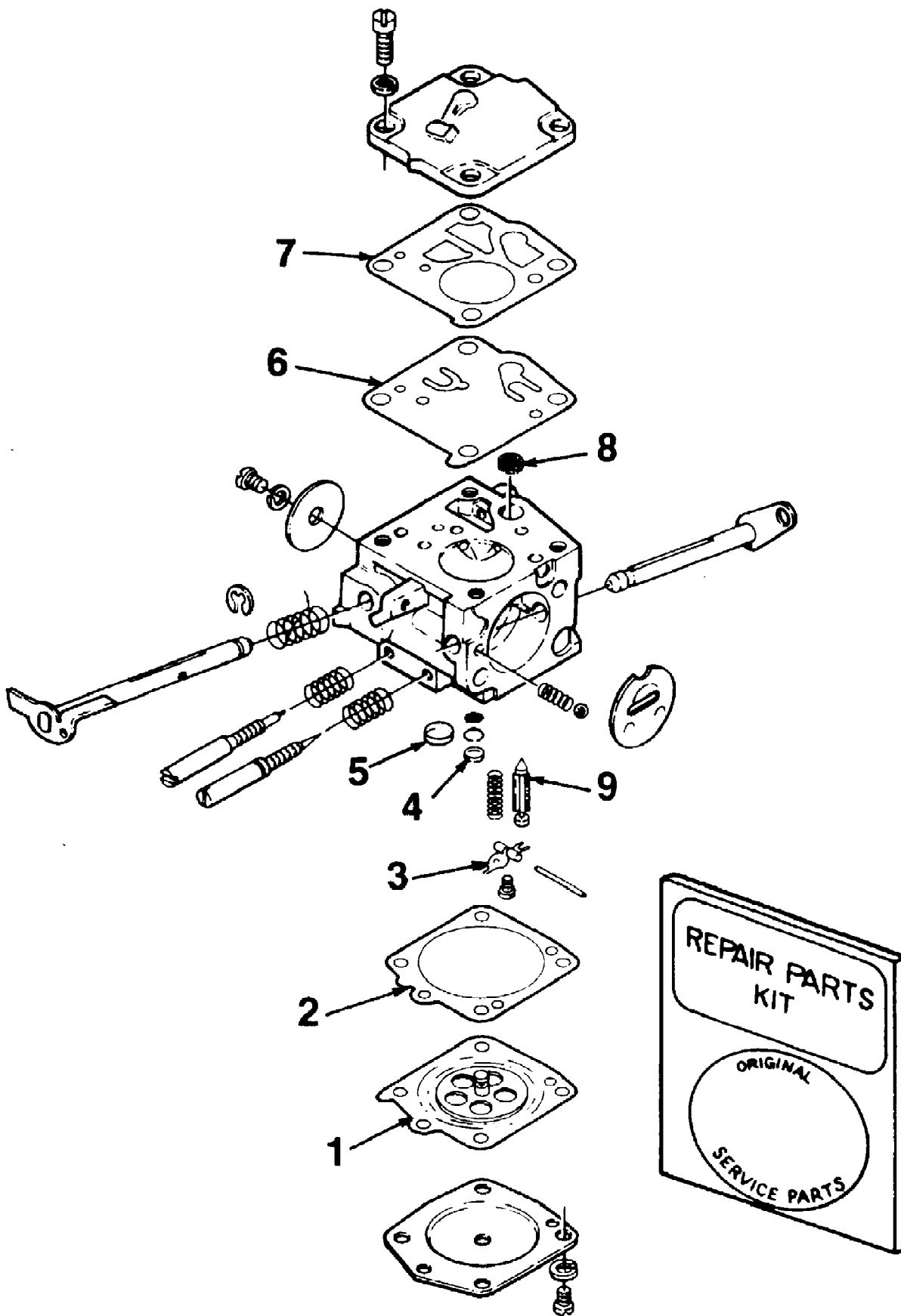

SXLAO Chain Saw UT-10489-A
HS-179-B Carburetor

Ref #	Part Number	Qty	S/P/F	Description
1	95698	1	/P	Repair Kit
2	95698	1	/P	Repair Kit
3	95698	1	/P	Repair Kit
4	95698	1	/P	Repair Kit
5	95698	1	/P	Repair Kit
6	95698	1	/P	Repair Kit
7	95698	1	/P	Repair Kit
8	95698	1	/P	Repair Kit
9	95698	1	/P	Repair Kit

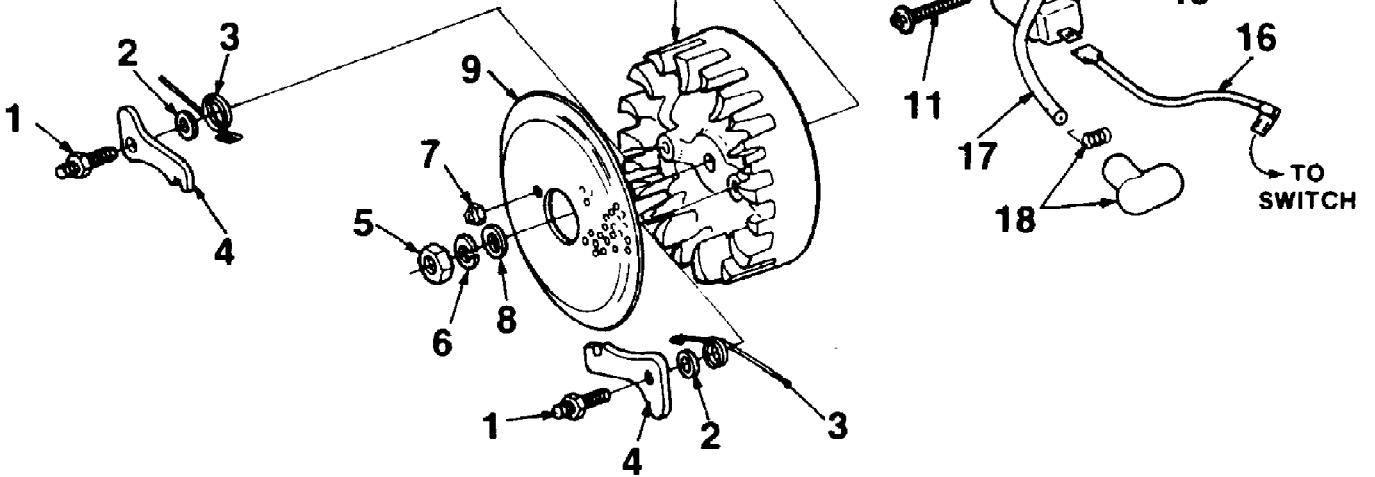
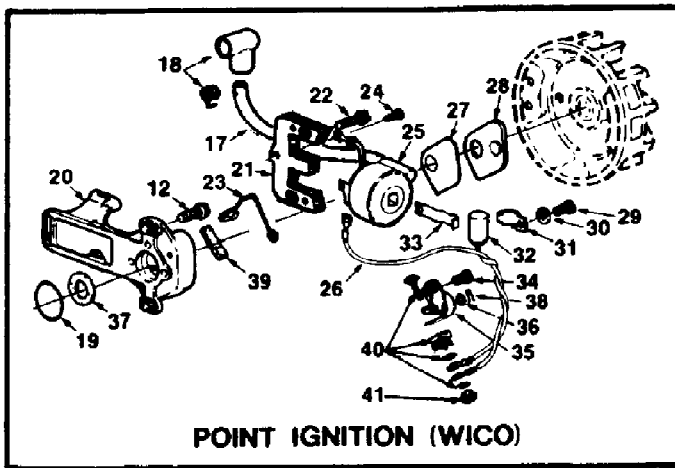

Ref #	Part Number	Qty	S/P/F	Description
1	58757E	2	/P	STUD- Shoulder
2	70901	2	/P	WASHER- Lock
3	653752	2	S	SPRING- Starter pawl
4	58756	2	S	PAWL- Starter
5	81117	1	/P	NUT- Hex (5/16-24)
6	83002	1	/P	WASHER- Lock (5/16)
7	81206	2	S/P	NUT- Center lock (#10-32)
8	84056	1	S	WASHER- Flat (5/16)
9	58765	1		SCREEN- Starter
10	70639	1	/P	ROTOR- Magneto
11	82248	2		SCREW- Hex washer hd. (8-32 x 3/4)
12	80899	3		SCREW- Hex hd. (12-24 x 9/16)
13	943261	1	/P	PLATE- Ignition coil mtg. (Solid state)
14	75078	1		KEY- Rotor (woodruff)
15	A94605S	1	S	MODULE & CORE (Solid state)
16	A94850	1	/P	LEAD- Ground (Solid state)
	A59031	1		LEAD- Ground (Point ignition)
17	58966	1		LEAD- High tension
18	A33055	1	/P	TERMINAL- High tension
19	59538	1		GASKET- Stator (point ignition)
20	A94556	1		BOX- Breaker (point ignition)
21	93098	1		CORE
22	82248	2		SCREW- Hex washer hd. (8-32 x 3/4)
23	76413	1		CLIP- Breaker box cover (point ignition)
24	64090	1		SCREW- Terminal (point ignition)
25	A94325	1	/P	COIL- with lead (point ignition)
26	93095	1		LEAD
27	58810	1		GASKET- Breaker box cover (point ignition)
28	58811	1		COVER- Breaker box (point ignition)
29	30261	1		SCREW- Hd. (8-32 x 5/16) (point ignition)
30	83060	2	S	WASHER- Lock (point ignition)
31	59622	1		CLAMP- Condenser (point ignition)
32	63250A	1	S	CONDENSER (point ignition)
33	63726	1		CLIP- Coil retaining (point ignition)
34	76421	1		SCREW- Contact plate (point ignition)
35	A58914A	1	/P	POINTS- Breaker (point ignition)
36	28028	A/R		WASHER- Plain
37	59760	1		SEAL- Felt
38	28008	1		CLIP
39		1		CAM- Felt
40	A68162	1		BLOCK- Terminal (point ignition)
41	93099	1		NUT- Connection stud

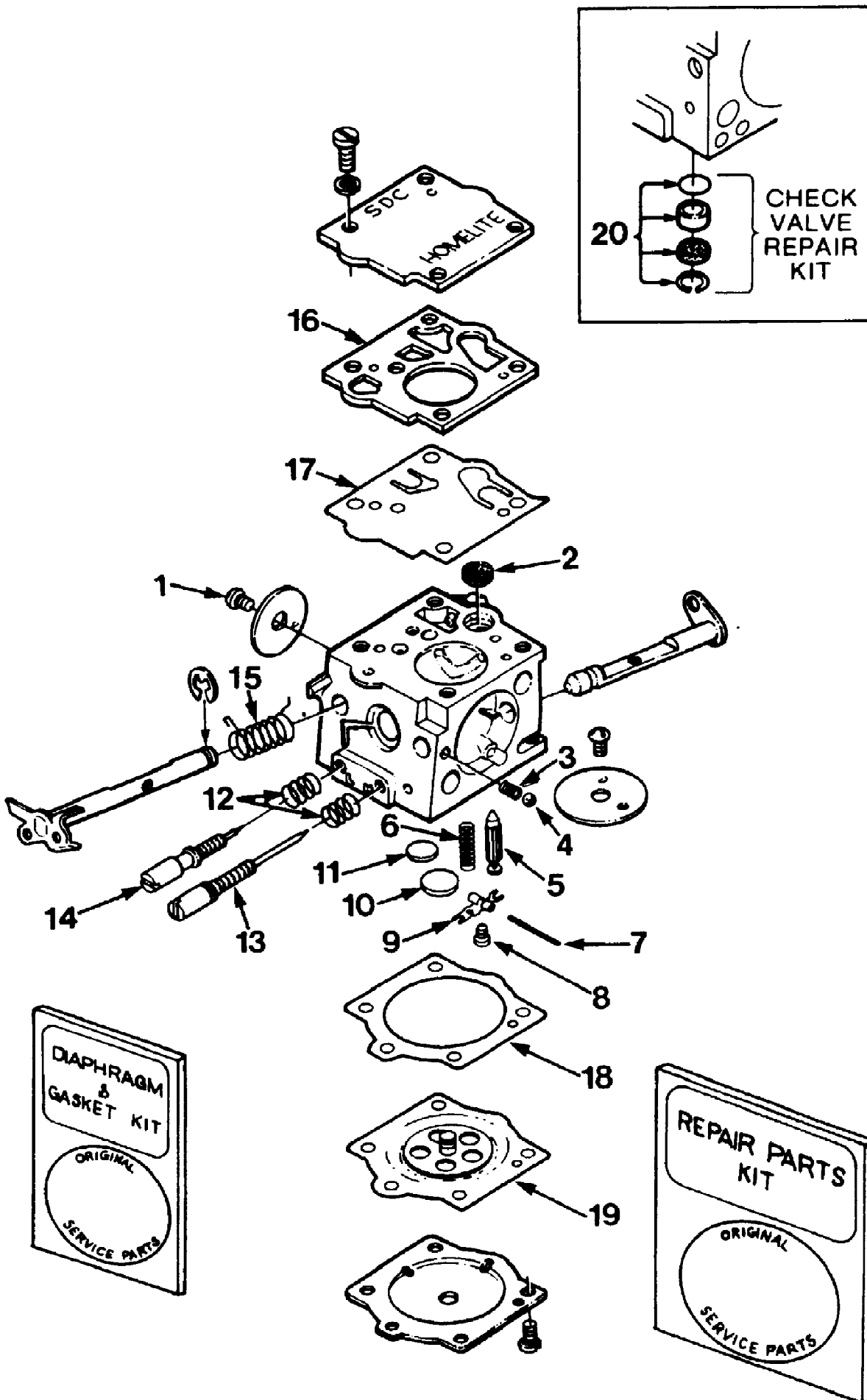

Ref #	Part Number	Qty	S/P/F	Description
1	67020	1		Repair Kit
2	67020	1		Repair Kit
3	67020	1		Repair Kit
4	67020	1		Repair Kit
5	67020	1		Repair Kit
	64229	1	S	Inlet Needle
6	67020	1		Repair Kit
7	67020	1		Repair Kit
8	67020	1		Repair Kit
9	67020	1		Repair Kit
10	67020	1		Repair Kit
11	67020	1		Repair Kit
12	67020	1		Repair Kit
13	67020	1		Repair Kit
14	67020	1		Repair Kit
15	67020	1		Repair Kit
16	67020	1		Repair Kit
	70811	1		Diaphragm & Gasket Kit
17	67020	1		Repair Kit
	70811	1		Diaphragm & Gasket Kit
18	67020	1		Repair Kit
	70811	1		Diaphragm & Gasket Kit
19	67020	1		Repair Kit
	70811	1		Diaphragm & Gasket Kit
20	93910A	1		Check Valve Kit

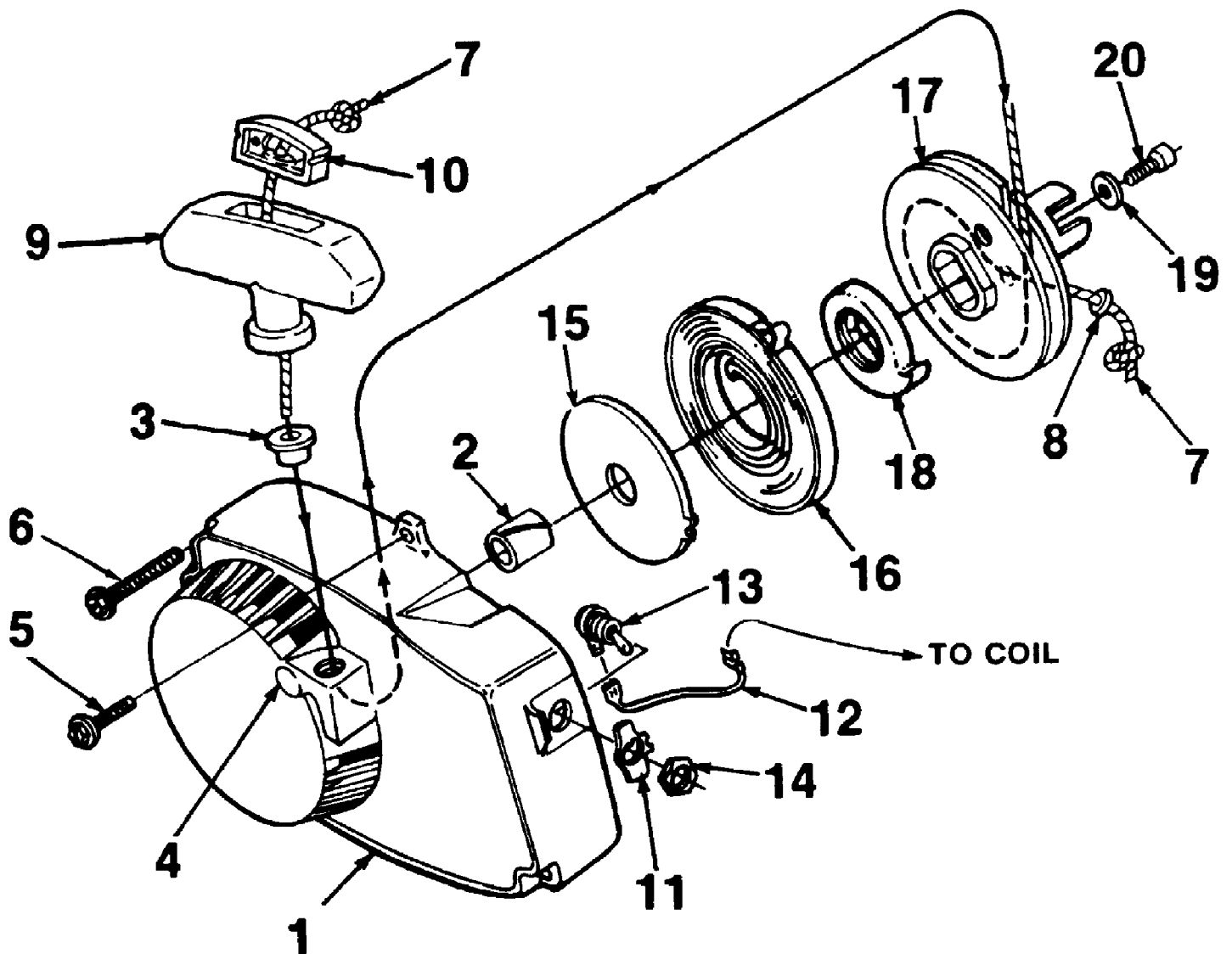

SXLAO Chain Saw UT-10489-A
Starter

Page 16 of 21

Ref #	Part Number	Qty	S/P/F	Description
1	A64518	1	S	HOUSING- Fan
2	64443	1	/P	BUSHING- Starter
3	67177	1		BUSHING- Rope
4	59067	1		DRIVE- Stud
5	80899	1		SCREW- Hex 12-24 x 9/16
6	58963	3		SCREW- Hex 12-24 x 1 1/16
7	A93875	1	S	ROPE- Starter 48" long #5
8	93862	1	/P	WASHER- Flat (nylon)
9	A69962B	1	/P	GRIP- Starter rope
10	70018A	1	/P	INSERT
11	95231	1	S	PLATE-"On-Off"
12	A94850	1	/P	LEAD- Ground (solid state)
	A59031	1		LEAD- Ground (point ignition)
13	96831	1	/P	SWITCH & LEAD
14	72084A1	1	S	NUT
15	59638B	1	/P	SHIELD- Spring (inner)
16	A94842	1	/P/F	SPRING- Recoil
17	A64446	1	/P	PULLEY- Starter
18	94827	1	S	BUSHING- Spring
19	58763	1		WASHER- Retainer
20	80648	1	/P	SCREW- Hex 10-32 x 1/2

TOOLS FOR XL-12

DESCRIPTION	PART NO.
PLIERS- Piston snap ring	22828
PLUG- Bearing assembly & disassembly	23756
PLUG- Bearing assembly & disassembly Drive & Crankcase	23757
PLUG- Seal assembly-drive & crankcase	23758
PLUG- Piston pin removal	A-23949
Includes:	
"O" RING	67900
PULLER- Magneto remover	A-24290
SLEEVE- Seal protecting-crankcase	23759
SLEEVE- Seal installation-drive and crankcase	23800
WRENCH- Hex socket screw (conn rod)	23528
WRENCH- Spanner to assembly & disassemble clutch	A-23934
Includes:	
PIN	23954
WRENCH- Socket	68651
SCREWDRIVER	24541
TOOL- Clutch removal (for clutch conversion kit)	A-17146

ACCESSORIES

DESCRIPTION	PART NO.	XL-12	SXL-AO
CLUTCH- Conversion Kit (Lined)	A-96745	1	1
Includes:			
SHOE- Clutch	A-93632-A	3	3
SPIDER- Clutch	93639	3	3
SPRING- Clutch	93814-A	3	3
SPROCKET & DRUM	A-95465	1	1
THRUST WASHER	93643	1	1
THRUST WASHER	93650	1	1
THRUST WASHER	65064	1	1
KIT- Manual oil pump (Prior to s/n 50440501)	A-65868		1
Includes:			
BUTTON	57289-1		1
LINE- Oil	A-59819		1
Includes:			
GROMMET	59794		1
VALVE- Check	A-59818		1
FILTER- Oil (Intake)	A-59804-A		1
PLUNGER	A-57834-10		1
Includes:			
"O" RING	74388		1
"O" RING	59074		1
SPRING	59293		1

When this Kit is assembled to the unit, the unit will have a complete manual oil pump system.

KIT- Hand guard	A-70910-A		1
Includes:			
WASHER	58851-2		1
WASHER	70788		1
SLEEVE	70911		1
SCREW- Machine flat hd.	70926		1
SCREW	80945		1
NUT	81225		1
SCREW	82223		1
DECAL	96990		1
KIT- Hand Guard	A-70944-A		1
WASHER	58851-2		1
WASHER	70788		1
SLEEVE	70911		1
SCREW	80945		1
NUT	81225		1
KIT- Safe•T•TIP (Standard)	DA-70790-A		1
Includes:			
SCREW	82335		1
CARRY CASE	95920		1
REEL- Starting rope (250 Ft.) #5	57084-1		1
KIT- Insert (for drivecase guide barstuds)	A-70370-A		1
TUBING- Rubber 10 ft. (Fuel)	70310-99		1
TUBING- Rubber 10 ft. (Oil)	70309-99		1
THROTTLE HANDLE			
CONVERSION KIT	A-97553		1
(For the XL-12 single reed system)			

PAINT

DESCRIPTION	PART NO.	XL-12	SXL-AO
LACQUER- Red	23475	1	1
LACQUER- Black	22772	1	1

TOOLS FOR THE SXL-AO

DESCRIPTION	PART NO.
ANVIL- Crankshaft	23846-4
COLLAR- Ball bearing installation	22820-1
DRIVER- Check valve (for SDC carburetor)	24173
JACKSCREW	A-23137
PLIERS- Piston snap ring	22828
PLUG- Bearing assembly connecting rod	23756
Drive & Crankcase	23757
PLUG- Seal assembly - drive & crankcase	23758
PLUG- Seal installation Drivecase assembly	23845
PLUG- Piston pin removal	A-23949
Includes:	
"O" RING	67900
PULLER- Magneto remover	A-24290
SLEEVE- Bearing & Shaft installation	23884-A
SLEEVE- Bearing & Shaft installation	23136-2A
SLEEVE- Seal protecting	23844
SLEEVE- Seal protecting crankcase	23759
SLEEVE- Seal installation drivecase	23843
SLEEVE- Seal installation drive & crankcase	23800
WRENCH- Hex socket screw (connecting rod)	23528
WRENCH- Spanner to assemble & Disassemble clutch	A-23934
Includes:	
PIN	23954
WRENCH- Socket	68651
WRENCH- Insert	A-24322
SCREWDRIVER	24541
TOOL- Clutch removal (for clutch conversion kit)	A-17146
BIT- Driver torx 1/4" hex shank	24982-01
BIT- Driver torx 5/16" hex shank	24982-02

Ref #	Part Number	Qty	S/P/F	Description
22828	22828	1		PLIERS- Piston snap ring
23756	23756	1		PLUG- Bearing assembly & disassembly
23757	23757	1		PLUG- Bearing assembly & disassembly Drive & Crankcase
23758	23758	1	S	PLUG- Seal assembly-drive & crankcase
A-23949	A23949	1		PLUG- Piston pin removal
67900	67900	1	/P	"O" RING
A-24290	A24290	1	/P	PULLER- Magneto remover
23759	23759	1		SLEEVE- Seal protecting-crankcase
23800	23800	1	S	SLEEVE- Seal installation-drive and crankcase
23528	23528	1		WRENCH- Hex socket screw (conn rod)
A-23934	A23934	1	/P	WRENCH- Spanner to assembly & disassemble clutch
23954	23954	1		PIN
68651	68651	1	S	WRENCH- Socket
24541	24541	1	S	SCREWDRIVER
A-17146	A17146	1	S	TOOL- Clutch removal (for clutch conversion kit)
238464	238464	1		ANVIL- Crankshaft
22820-1	228201	1		COLLAR- Ball bearing installation
24173	24173	1		DRIVER- Check valve (or SDC carburetor)
A-23137	A23137	1		JACKSCREW
22828	22828	1		PLIERS- Piston snap ring
23756	23756	1		PLUG- Bearing assembly connecting rod
23757	23757	1		Drive & Crankcase
23758	23758	1	S	PLUG- Seal assembly - drive & crankcase
23845	23845	1		PLUG- Seal installation drivecase assembly
A-23949	A23949	1		PLUG- Piston pin removal
67900	67900	1	/P	"O" RING
A-24290	A24290	1	/P	PULLER- Magneto remover
23884-A	23884A	1		SLEEVE- Bearing & Shaft installation
23136-2A	231362A	1	/P	SLEEVE- Bearing & Shaft installation
23844	23844	1		SLEEVE- Seal protecting
23759	23759	1		SLEEVE- Seal protecting crankcase
23843	23843	1		SLEEVE- Seal installation drivecase
23800	23800	1	S	SLEEVE- Seal installation drive & crankcase
23528	23528	1		WRENCH- Hex socket screw (connecting rod)
A-23934	A23934	1	/P	WRENCH- Spanner to assemble & Disassemble clutch
23954	23954	1		PIN
68651	68651	1	S	WRENCH- Socket
A-24322	A24322	1		WRENCH- Insert
24541	24541	1	S	SCREWDRIVER
A-17146	A17146	1	S	TOOL- Clutch removal (for clutch conversion kit)
2498201	2498201	1		BIT- Driver torx 1/4" hex shank
2498202	2498202	1	/P	BIT- Driver torx 5/16" hex shank
A-96745	A96745	1		CLUTCH- Conversion Kit (Lined)

Ref #	Part Number	Qty	S/P/F	Description
A-93632-A	A93632A	3	S	SHOE- Clutch
93639	93639	3	S	SPIDER- Clutch
93814-A	93814A	3	S	SPRING- Clutch
A-95465	A95465	1		SPROCKET & DRUM
93643	93643	1		THRUST WASHER
93650	93650	1	/P	THRUST WASHER
65064	65064	1		THRUST WASHER
A-65868	A65868	1	F	KIT- Manual oil pump (Prior to s/n 50440501)
57289-1	572891	1		BUTTON
A-59819	A59819	1		LINE- Oil
59794	59794	1		GROMMET
A-59818	A59818	1		VALVE- Check
A-59804-A	A59804A	1		FILTER- Oil (intake)
A-57834-10	A5783410	1	/P	PLUNGER
74388	74388	1	S	"O" RING
59074	59074	1	/P	"O" RING
59293	59293	1	/P	SPRING
A-70910-A	A70910A	1		KIT- Hand guard
588512	588512	1	/P	WASHER
70788	70788	1	S	WASHER
70911	70911	1		SLEEVE
70926	70926	1		SCREW- Machine flat hd.
80945	80945	1		SCREW
81225	81225	1	/P	NUT
82223	82223	1		SCREW
96990	96990	1		DECAL
A-70944-A	A70944A	1		KIT- Hand Guard
588512	588512	1	/P	WASHER
70788	70788	1	S	WASHER
70911	70911	1		SLEEVE
80945	80945	1		SCREW
81225	81225	1	/P	NUT
DA70790A	DA70790A	1		KIT- Safe-T-TIP (Standard)
82335	82335	1	S	SCREW
95920	95920	1	S	CARRY CASE
57084-1	570841	1	/P	REEL- Starting rope (250 Ft.) #5
A-70370-A	A70370A	1		KIT- Insert (for drivecase guide barstuds)
7031099	7031099	1	S	TUBING- Rubber 10 ft. (Fuel)
7030999	7030999	1	/P	TUBING- Rubber 10 ft. (Oil)
A-97553	A97553	1	/P	THROTTLE HANDLE CONVERSION KIT (For the XL-12 single reed system)
23475	23475	1	/P	LACQUER- Red
22772	22772	1		LACQUER- Black

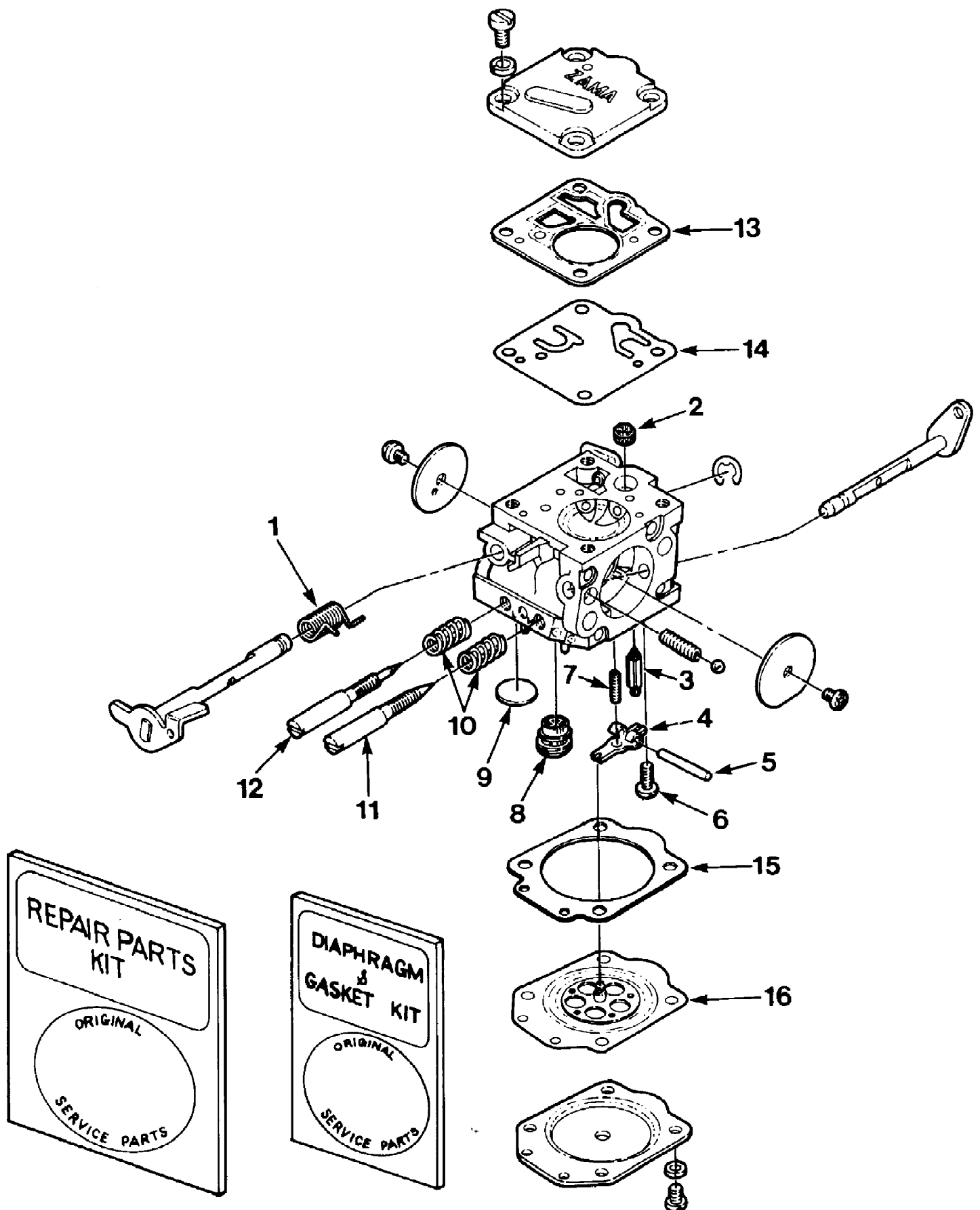

Ref #	Part Number	Qty	S/P/F	Description
1	94954	1		Repair Kit
2	94954	1		Repair Kit
3	94954	1		Repair Kit
4	94954	1		Repair Kit
5	94954	1		Repair Kit
6	94954	1		Repair Kit
7	94954	1		Repair Kit
8	94954	1		Repair Kit
9	94954	1		Repair Kit
10	94954	1		Repair Kit
11	94954	1		Repair Kit
12	94954	1		Repair Kit
13	94954	1		Repair Kit
	94952	1		Diaphragm & Gasket Kit
14	94954	1		Repair Kit
	94952	1		Diaphragm & Gasket Kit
15	94954	1		Repair Kit
	94952	1		Diaphragm & Gasket Kit
16	94954	1		Repair Kit
	94952	1		Diaphragm & Gasket Kit