

---

---





## FOREWORD

---

This manual contains service, maintenance, and troubleshooting information for the 2007 Arctic Cat Y-12 Youth ATV. The manual is designed to aid service personnel in service-oriented applications and may be used as a textbook for service training.

This manual is divided into sections. Each section covers a specific ATV component or system and, in addition to the standard service procedures, includes disassembling, inspecting, and assembling instructions. When using this manual as a guide, the technician should use discretion as to how much disassembly is needed to correct any given condition. A troubleshooting section is also included in this manual.

The service technician should become familiar with the operation and construction of each component or system by carefully studying this manual. This manual will assist the service technician in becoming more aware of and efficient with servicing procedures. Such efficiency not only helps build consumer confidence but also saves time and labor.

All Arctic Cat ATV publications and decals display the words Warning, Caution, Note, and At This Point to emphasize important information. The symbol  **WARNING** identifies personal safety-related information. Be sure to follow the directive because it deals with the possibility of severe personal injury or even death. The symbol  **CAUTION** identifies unsafe practices which may result in ATV-related damage. Follow the directive because it deals with the possibility of damaging part or parts of the ATV. The symbol  **NOTE:** identifies supplementary information worthy of particular attention. The symbol  **AT THIS POINT** directs the technician to certain and specific procedures to promote efficiency and to improve clarity.

At the time of publication, all information, photographs, and illustrations were technically correct. Some photographs used in this manual are used for clarity purposes only and are not designed to depict actual conditions. Because Arctic Cat Inc. constantly refines and improves its products, no retroactive obligation is incurred.

All materials and specifications are subject to change without notice.

Keep this manual accessible in the shop area for reference.

**Product Service and  
Warranty Department  
Arctic Cat Inc.**

---

---

## TABLE OF CONTENTS

---

### Foreword

Click on the red text to go.

### Section



#### 1. General Information

1

#### 2. Periodic Maintenance/Tune-Up

2

#### 3. Engine/Transmission

3



#### 4. Fuel/Lubrication/Cooling

4

#### 5. Electrical System

5



#### 6. Drive System

6

#### 7. Suspension

7

#### 8. Steering/Frame

8

#### 9. Controls/Indicators

9

#### 10. Aids for Maintenance

10

#### 11. Troubleshooting

11

# SECTION 1 - GENERAL INFORMATION

---

---

## TABLE OF CONTENTS

---

Specifications .....	1-2
Break-In Procedure .....	1-2
Gasoline-Oil-Lubricant .....	1-2
Genuine Parts .....	1-3
Preparation For Storage .....	1-3
Preparation After Storage.....	1-4

## Specifications\*

CARBURETOR	
Type	Keihin PTE
Main Jet	80
Slow Jet	40
Pilot Screw Setting (turns)	1 3/8
Jet Needle	NBSD-3
Needle Jet	3.4/2.5
Throttle Valve Cutaway	3.0
Idle RPM	1700
Needle Valve/Seat	1.6
Float Arm Height	10.2 mm (0.40 in.)
Throttle Cable Free-Play (at lever)	6.0 mm (0.25 in.)
ELECTRICAL	
Ignition Type	CDI
Spark Plug Type	CR7HSA
Spark Plug Gap	0.6-0.7 mm (0.024-0.028 in.)
CHASSIS	
Length (Overall)	146.8 cm (57.8 in.)
Height (Overall)	96.2 cm (37.9 in.)
Width (Overall)	87.6 cm (34.5 in.)
Suspension Travel (Front/Rear)	71.00 mm (2.8 in.) 73.66 mm (2.9 in.)
Wheelbase	97.5 cm (38.38 in.)
Tire Size (Front/Rear)	AT20 x 7-8 AT19 x 8-8
Tire Inflation Pressure	0.21 kg-cm <sup>2</sup> (3.0 psi)
MISCELLANY	
Dry Weight (Approx)	118 kg (260 lb) - DVX 123 kg (271 lb) - Utility
Gas Tank Capacity (Rated)	5.5 L (1.4 U.S. gal.)
Reserve Capacity	1.3 L (0.34 U.S. gal.)
Transmission Lubricant (Recommended)	SAE 80W-90 Hypoid
Transmission Lubricant Capacity	100 ml (3.4 fl oz)
Engine Oil Capacity	0.8 L (0.84 U.S. qt)
Gasoline (Recommended)	87 Octane Regular Unleaded
Engine Oil (Recommended)	5W-30
Brake Type	Front Double Drum/Rear Hydraulic Disc w/Brake Lever Locks
Starting System	Electric w/Kick Start (Emergency)

\* Specifications subject to change without notice.

## Break-In Procedure

A new ATV and an overhauled ATV engine require a “break-in” period. The first month is most critical to the life of this ATV. Proper operation during this break-in period will help assure maximum life and performance from the ATV.

During the first three hours of operation, always use less than 1/2 throttle. Varying the engine RPM during the break-in period allows the components to “load” (aiding the mating process) and then “unload” (allowing components to cool). Although it is essential to place some stress on the engine components during break-in, care should be taken not to overload the engine too often.

When the engine starts, allow it to warm up properly. Idle the engine several minutes until the engine has reached normal operating temperature. Do not idle the engine for excessively long periods of time.

After the completion of the break-in period, the engine lubricant should be changed. Other maintenance after break-in should include checking of all prescribed adjustments and tightening of all fasteners.

## Gasoline-Oil-Lubricant

### RECOMMENDED GASOLINE

The recommended gasoline to use is 87 minimum octane regular unleaded. In many areas, oxygenates (either ethanol or MTBE) are added to the gasoline. Oxygenated gasolines containing up to 10% ethanol, 5% methane, or MTBE are acceptable gasolines.

### CAUTION

**Do not use white gas. Only Arctic Cat approved gasoline additives should be used.**

### RECOMMENDED ENGINE OIL

The recommended oil to use is Arctic Cat 4-Cycle Oil.

### RECOMMENDED TRANSMISSION LUBRICANT

The recommended transmission lubricant to use is SAE 80W-90 hypoid.

## FILLING GAS TANK

### **⚠ WARNING**

Always fill the gas tank in a well-ventilated area. Never add gasoline to the ATV gas tank near any open flames or with the engine running or hot. DO NOT SMOKE while filling the gas tank.

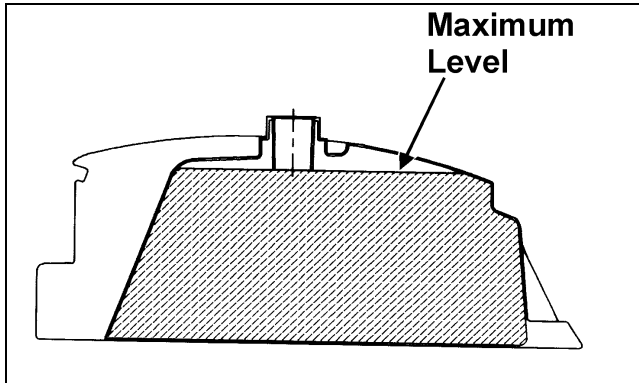

ATV0049B

Since gasoline expands as its temperature rises, the gas tank must be filled to its rated capacity only. Expansion room must be maintained in the tank particularly if the tank is filled with cold gasoline and then moved to a warm area.

### **⚠ WARNING**

Do not over-fill or overflow gasoline when filling the gas tank. A fire hazard could materialize. Always allow the engine to cool before filling the gas tank.

Tighten the gas tank cap securely after filling the tank.

## Genuine Parts

When replacement of parts is necessary, use only genuine Arctic Cat ATV parts. They are precision-made to ensure high quality and correct fit. Refer to the appropriate Illustrated Parts Manual for the correct part number, quantity, and description.

## Preparation For Storage

### **⚠ CAUTION**

Prior to storing the ATV, it must be properly serviced to prevent rusting and component deterioration.

Arctic Cat recommends the following procedure to prepare the ATV for storage.

1. Clean the seat cushion (cover and base) with a damp cloth and allow to dry.
2. Clean the ATV thoroughly by washing dirt, oil, grass, and other foreign matter from the entire ATV. Allow the ATV to dry thoroughly. DO NOT get water into any part of the engine or air intake.
3. Either drain the gas tank or add Fuel Stabilizer to the gas in the gas tank. Remove the air filter housing cover and air filter. Start the engine and allow it to idle; then using Arctic Cat Engine Preserver, rapidly inject the preserver into the air filter opening for a period of 10 to 20 seconds. Install the air filter and housing cover.

### **⚠ CAUTION**

If the interior of the air filter housing is dirty, clean the area before starting the engine.

4. Drain the carburetor float chamber.
5. Plug the hole in the exhaust system with a clean cloth.
6. Apply light oil to the upper steering post bushing and plungers of the shock absorbers.
7. Tighten all nuts, bolts, cap screws, and screws. Make sure rivets holding components together are tight. Replace all loose rivets. Care must be taken that all calibrated nuts, cap screws, and bolts are tightened to specifications (see Section 10).
8. Disconnect the battery cables (negative cable first); then remove the battery, clean the battery posts and cables, and store in a clean, dry area.

### **⚠ CAUTION**

This maintenance-free battery should be charged at the recommended rate every 30 days or permanent damage will result if the battery completely discharges.

9. Store the ATV indoors in a level position.

### **⚠ CAUTION**

Avoid storing outside in direct sunlight and avoid using a plastic cover as moisture will collect on the ATV causing rusting.

1

www.arcticcat.com



Back to TOC

Back to Section TOC



---

---

## Preparation After Storage

---

Taking the ATV out of storage and correctly preparing it will assure many miles and hours of trouble-free riding. Arctic Cat recommends the following procedure to prepare the ATV.

1. Clean the ATV thoroughly.
2. Clean the engine.
3. Remove the cloth from the exhaust system.
4. Check all control wires and cables for signs of wear or fraying. Replace if necessary.
5. Change the transmission lubricant.
6. Charge the battery; then install. Connect the battery cables making sure to connect the positive cable first.
7. Check the entire brake system (cables, shoes, etc.), and all controls. Adjust or replace if necessary.
8. Check the tire pressure. Inflate to recommended pressure as necessary.
9. Tighten all nuts, bolts, cap screws, and screws making sure all calibrated nuts, cap screws, and bolts are tightened to specifications (see Section 10).
10. Make sure the steering moves freely and does not bind.
11. Check the spark plug. Clean or replace as necessary.

# SECTION 2 - PERIODIC MAINTENANCE/TUNE-UP

2

---

---

## TABLE OF CONTENTS

---

Periodic Maintenance Chart.....	2-2
Lubrication Points.....	2-3
Battery.....	2-3
Fuse.....	2-3
Air Filter.....	2-4
Valve/Tappet Clearance.....	2-4
Testing Engine Compression.....	2-6
Spark Plug.....	2-6
Muffler/Spark Arrester.....	2-7
Gas/Vent Hoses.....	2-7
Adjusting Throttle Cable.....	2-7
Adjusting Engine RPM (Idle).....	2-8
Transmission Lubricant.....	2-8
Engine Oil.....	2-9
Tires.....	2-10
Steering Components.....	2-10
Drive Chain/Sprockets.....	2-10
Suspension/Shock Absorbers/Bushings.....	2-10
Nuts/Bolts/Cap Screws.....	2-10
Ignition Timing.....	2-11
Brakelight.....	2-11
Switches.....	2-11
Frame/Welds.....	2-11
Electrical Connections.....	2-11
Brake Systems.....	2-11
Replacing Drive Belt.....	2-14

# Periodic Maintenance Chart

A = Adjust  
 C = Clean  
 CH = Charge  
 D = Drain  
 I = Inspect  
 L = Lubricate  
 R = Replace  
 T = Tighten

Item	Initial Service After Break-In (First Mo)	Every Day	Every Month	Every 3 Months	Every 6 Months	Every Year	As Needed
Battery	I		CH			I	C
Fuse				I			R
Air Filter	I		C*				R
Engine Compression						I	
Spark Plug				I/C			R (4000 Mi or 18 Mo)
Chassis				C*/L*		I	
Gas/Vent Hoses		I					C, R (2 Years)
Fuel Valve						I	C
Throttle Cable	I	I			C/L		A, R
Carburetor	I			C/D*		C/D*	
Engine RPM (Idle)	I					I	I/A
Engine Oil	R	I		R			
Valve/Tappet Clearance	A					A	
Transmission Lubricant/Level	R						I
Fuel Filter	I			I			R
Tires/Air Pressure/Wear	I	I					I/R
Steering Components	I	I					R
Drive Chain	I			C*/L*			R
Suspension (Tie Rods, Protective Boots)	I	I					R
Nuts/Bolts/Cap Screws	I		I/T				T
Ignition Timing							I
Brakelight	I	I					R
Switches		I					R
Kick Starter		I					C
Handlebar/Grips		I					R
Frame/Welds			I		I		
Electrical Connections	I					I	C
Complete Brake Systems	I	I		C*			L, R
Brake Fluid	I		I				R (2 Years)
Shock Absorbers			I				R

\*Service/Inspect more frequently when operating in adverse conditions.





## Lubrication Points

It is advisable to lubricate certain components periodically to ensure free movement. Apply light oil to the components using the following list as reference.

- A. Throttle Lever Pivot/Cable Ends
- B. Brake Lever Pivot/Cable Ends
- C. Brake Cable Ends
- D. Idle RPM Adjustment Screw (Carburetor)

## Battery

This maintenance-free battery requires periodic charging to prevent sulfiding. If the ATV will be idle for extended periods of time, either run the engine or trickle charge every 30 days. If planning to store the ATV, see Preparation for Storage in this manual. If the battery completely discharges, permanent damage will occur requiring replacement.

### CAUTION

The battery can be permanently damaged if the cap-strips over the cells are removed.

### WARNING

Battery posts, terminals, and related accessories contain lead and lead compounds, chemicals known to the State of California to cause cancer and reproductive harm. Wash hands after handling.

The battery is located beneath the seat.

If the battery is discharged, remove the battery from the ATV and charge the battery at the standard charging rate of 1.5 amps for 10 hours.

### WARNING

Anytime service is performed on a battery, the following must be observed: Keep sparks, open flame, cigarettes, or any other flame away. Always wear safety glasses. Protect skin and clothing when handling batteries. When servicing battery in enclosed space, keep the area well-ventilated.

To remove and charge the battery, use the following procedure:

1. Remove the seat; then remove the battery hold-down strap.

2. Disconnect the negative battery cable; then disconnect the positive battery cable.
3. Remove the battery from the ATV.

### CAUTION

Do not charge the battery while it is in the ATV with the battery terminals connected.

4. Trickle charge the battery at 1.5 amps for 10 hours.

### CAUTION

Never exceed the standard charging rate.

### CAUTION

Before installing the battery, make sure the ignition switch is in the OFF position.

5. Place the battery into position in the ATV.
6. Clean the battery posts and cable ends by using a battery post cleaning tool and/or a wire brush to remove dirt, grease, and corrosion.
7. Connect cables to the proper terminals: positive cable to the positive terminal (+) and negative cable to the negative terminal (-). Connect the negative cable last.

### CAUTION

Connecting cables in reverse (positive to negative and negative to positive) can cause serious damage to the electrical system.

8. Install the battery hold-down strap; then install the seat.

## Fuse

The main (7 amp) fuse is located on the frame near the battery under the seat.

■ **NOTE:** To remove the fuse, compress the locking tabs on either side of the fuse case and lift out.

If there is any type of electrical system failure, always check the fuse first.

### CAUTION

Always replace a blown fuse with a fuse of the same type and rating.

## Air Filter

The air filter inside the air filter housing must be kept clean to provide good engine power and gas mileage. If the ATV is used under normal conditions, service the filter at the intervals specified. If operated in dusty, wet, or muddy conditions, inspect and service the filter more frequently. Use the following procedure to remove the filter and inspect and/or clean it.

### ⚠ CAUTION

Failure to inspect the air filter frequently if the ATV is used in dusty, wet, or muddy conditions can damage the ATV engine.

1. Remove the seat; then remove five screws securing the air filter housing cover.

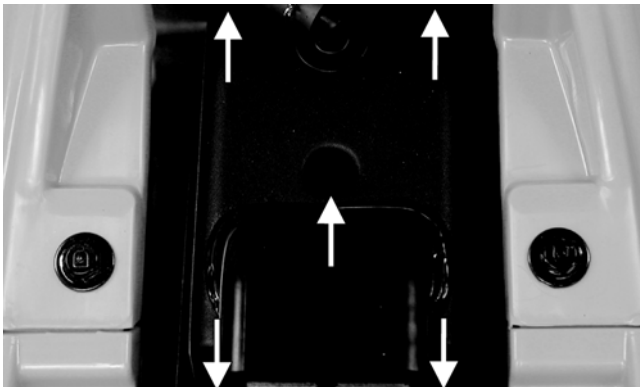

KM032A

2. Remove the air filter housing cover; then pull the filter out of the housing.
3. Fill a wash pan larger than the element with a non-flammable cleaning solvent; then dip the element in the solvent and wash it.

■ **NOTE: Foam Filter Cleaner and Foam Filter Oil are available from Arctic Cat.**

4. Compress the element by pressing it between the palms of both hands to remove excess solvent. Do not twist or wring the element or it will develop cracks.
5. Dry the element.
6. Put the element in a plastic bag; then pour in air filter oil and work the oil into the element.
7. Compress the element to remove excess oil.

### ⚠ CAUTION

A torn air filter can cause damage to the ATV engine. Dirt and dust may get inside the engine if the element is torn. Carefully examine the element for tears before and after cleaning it. Replace the element with a new one if it is torn.

8. Clean any dirt or debris from inside the air cleaner. Make sure no dirt enters the carburetor.
9. Install the air filter. Install air filter housing cover and secure with the five screws.

## Valve/Tappet Clearance

To check and adjust valve/tappet clearance, use the following procedure.

■ **NOTE: Valve/tappet clearance specifications are for room temperature (approximately 68° F).**

1. Remove the two cap screws and the two self-tapping screws securing the fan shroud; then remove the fan shroud.



CD651

2. Remove the breather tube from the valve cover; then remove the four cap screws and remove the valve cover. Account for the O-ring seal and the valve cover.



CD654

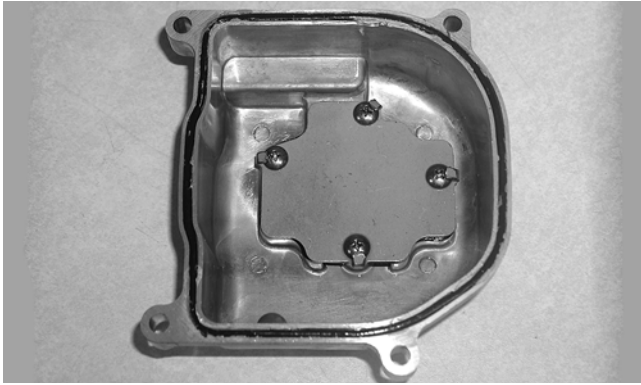

CD655

- Remove the spark plug wire and the spark plug; then rotate the engine clockwise to the TDC position on the compression stroke.

■ **NOTE:** The “T” mark on the rotor/flywheel is aligned with the timing pointer on the crankcase, and intake and exhaust valve adjuster screws must not have pressure on them. The two punch marks on the camshaft gear are aligned with the valve cover surface, and the hole in the timing gear points away from the engine.

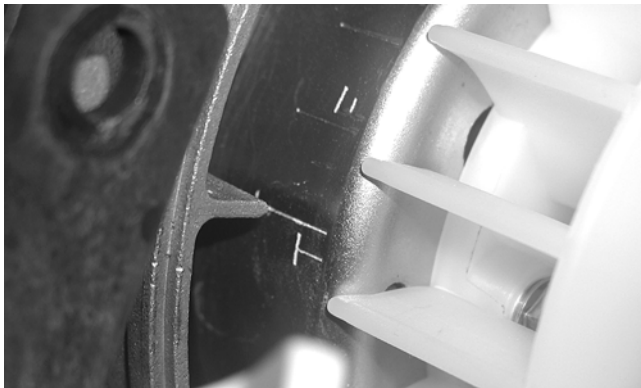

CD652

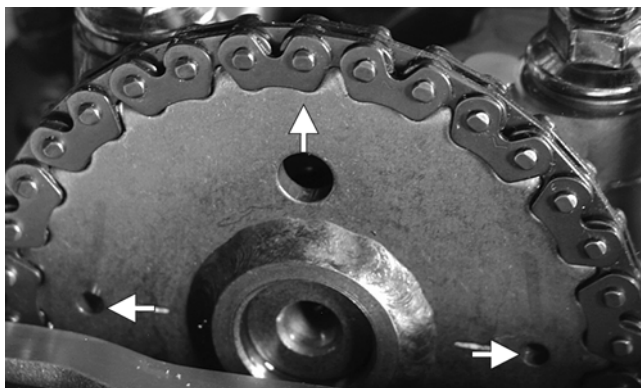

CD656A

- Using a feeler gauge, check each valve tappet clearance. If the clearance is not within specifications, loosen the jam nut and rotate the tappet adjuster screw until the clearance is within specifications. Tighten each jam nut securely after completing the adjustment.

VALVE/TAPPET CLEARANCE	
Intake	0.1 mm (0.0039 in.)
Exhaust	0.1 mm (0.0039 in.)



CD659

**2**

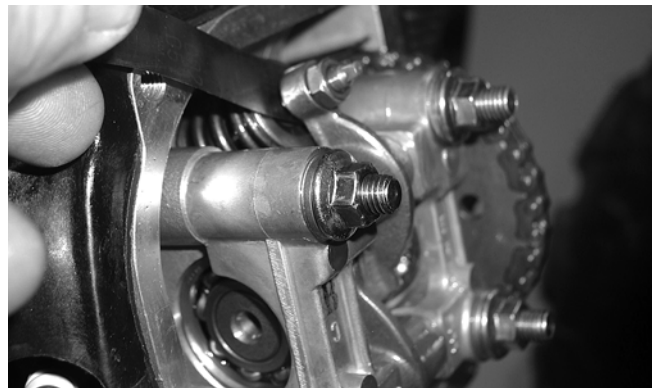

CD658

- Check the valve/tappet clearance after the jam nut has been tightened to ensure that the clearance did not change.

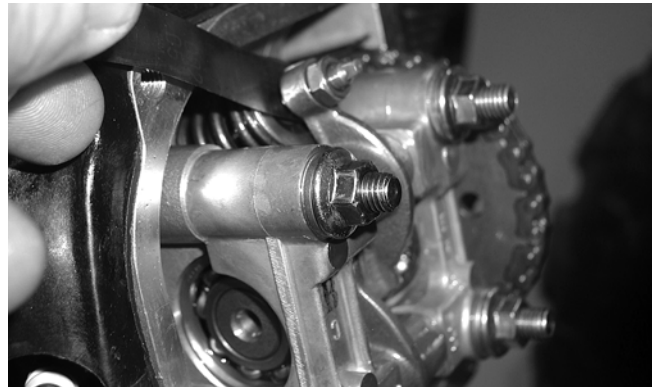

CD658

- Install the valve cover and tighten the four cap screws to specifications (see Section 10) using a crisscross pattern; then install the breather tube.
- Install the fan shroud and tighten the two cap screws securely. Tighten the self-tapping screws snug taking care not to strip the plastic cover.
- Install the spark plug and tighten to specifications (see Section 10); then install the spark plug wire.

## Testing Engine Compression

To test engine compression, use the following procedure.

1. Remove the high tension lead from the spark plug.
2. Using compressed air, blow any debris from around the spark plug.

### **⚠ WARNING**

**Always wear safety glasses when using compressed air.**

3. Remove the spark plug; then attach the high tension lead to the plug and ground the plug on the cylinder head well away from the spark plug hole.
4. Attach the Compression Tester Kit (p/n 0444-213).

■ **NOTE: The engine must be warm and the battery must be fully charged for this test.**

5. While holding the throttle lever in the full-open position, crank the engine over with the electric starter until the gauge shows a peak reading (five to 10 compression strokes).

■ **NOTE: Compression should be within a range of 195-230 psi in the full-open throttle position.**

6. If compression is abnormally low, inspect the following items.
  - A. Verify starter cranks engine over.
  - B. Gauge is functioning properly.
  - C. Throttle lever in the full-open position.
7. Pour 29.5 ml (1 fl oz) of oil into the spark plug hole, reattach the gauge, and retest compression.
8. If compression is now evident, service the piston rings (see Section 3).

## Spark Plug

A light brown insulator indicates that the plug is correct. A white or dark insulator indicates that the engine may need to be serviced or the carburetor may need to be adjusted. To maintain a hot, strong spark, keep the plug free of carbon.

### **⚠ CAUTION**

**Before removing the spark plug, be sure to clean the area around the spark plug. Dirt could enter engine when removing or installing the spark plug.**

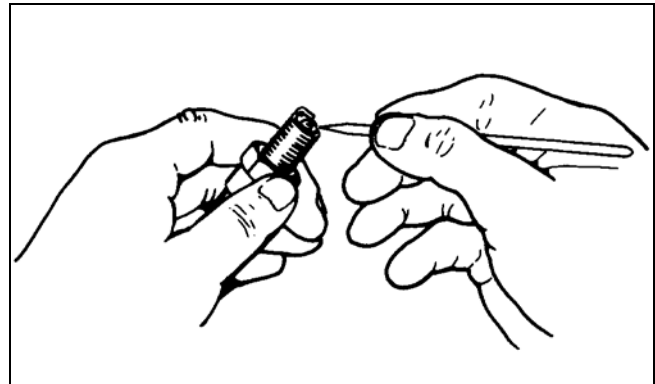

ATV-0051

Adjust the gap to 0.6-0.7 mm (0.024-0.028 in.) for proper ignition. Use a feeler gauge to check the gap.

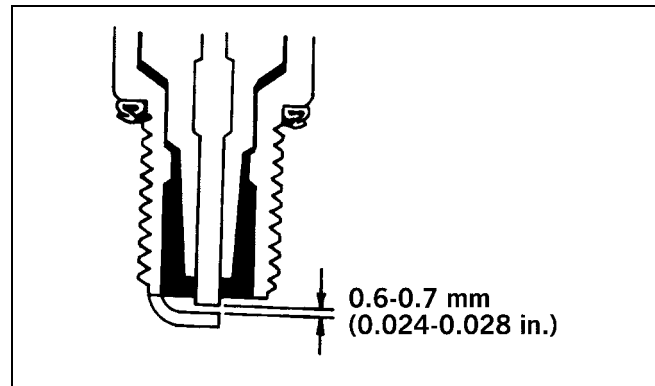

ATV-0052A

When installing the spark plug, be sure to tighten it to specifications. A new spark plug should be tightened 1/2 turn once the washer contacts the cylinder head. A used spark plug should be tightened 1/8 - 1/4 turn once the washer contacts the cylinder head.

## Muffler/Spark Arrester

The exhaust system has a muffler/spark arrester which can be removed and cleaned if it becomes clogged.

### **⚠ WARNING**

**Before removing the muffler/spark arrester, wait for it to cool to avoid burns.**

To clean the arrester, use the following procedure.

1. Remove the cap screw (1) securing the spark arrester assembly (2) to the rear of the muffler. Account for a gasket.



KM139A

2. Clean the screen (3) with a brush and parts-cleaning solvent. Dry with compressed air. If the screen has any holes or tears, it must be replaced.

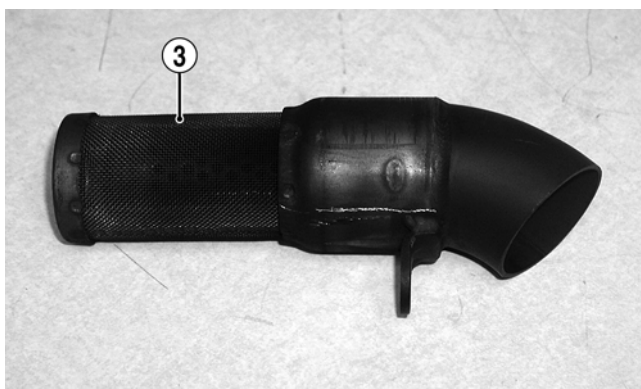

KM140B

### **⚠ WARNING**

**Before installing the spark arrester, wait for the muffler to cool to avoid burns.**

3. Install the spark arrester in the muffler and secure with the cap screws. Tighten securely.



KM139

## Gas/Vent Hoses

**2**

Replace the gas hose every two years. Damage from aging may not always be visible. Do not bend or obstruct the routing of the carburetor vent hose. Make certain that the vent hose is securely connected to the carburetor and the opposite end is always open.

## Adjusting Throttle Cable

To adjust the throttle cable free-play, use the following procedure.

1. Pull back rubber boot to access cable adjustment nut.

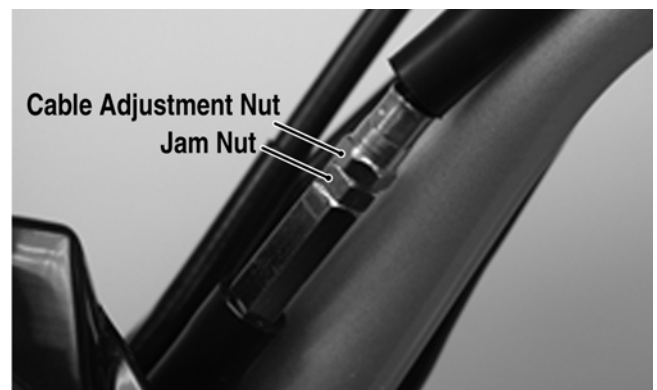

KM071A

2. Loosen jam nut to allow cable adjustment nut to be adjusted.
3. Turn cable adjustment nut clockwise to increase free-play in the cable. Turn the adjustment nut counterclockwise to decrease free-play in the cable.

4. There should be approximately 6 mm (0.25 in.) free-play in the cable.
5. Tighten the jam nut to secure the adjustment; then slide the rubber boot back into position.

---

---

## Adjusting Engine RPM (Idle)

---

To properly adjust the idle RPM, a tachometer is necessary. To adjust idle RPM, use the following procedure.

1. Set the brake lever locks. Start the engine and warm it up to normal operating temperature.

**⚠ CAUTION**

**Make sure the engine is fully warm before adjusting the idle RPM.**

2. Turn the idle adjustment screw in or out until the engine idles at 1700 RPM.

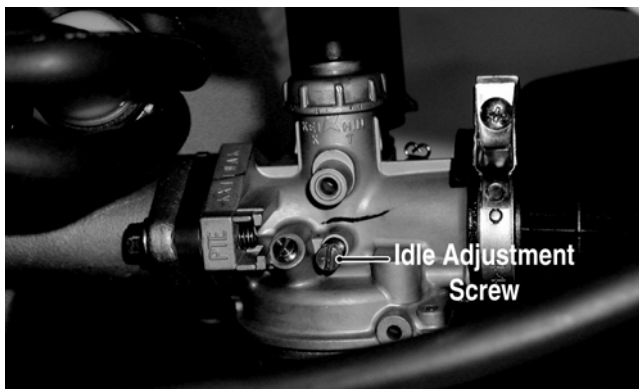

KM004A

**⚠ WARNING**

**Adjust the idle to the correct RPM. Make sure the engine is at normal operating temperature before adjusting the idle RPM.**

---

---

## Transmission Lubricant

---

1. Park the ATV on level ground.
2. Remove the level/fill plug from the left-rear of the transmission. Be careful not to allow contaminants to enter the opening.



KM039A

3. Remove the drain plug from the bottom of the transmission and drain the lubricant into a drain pan.

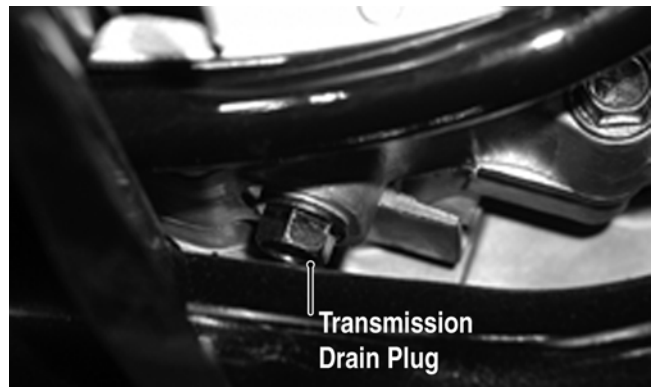

KM038A

4. Install the drain plug and tighten to specifications (see Section 10). Pour the recommended lubricant in the fill/level hole. Install the level/fill plug.
5. Start the engine (while the ATV is outside on level ground) and drive it a short distance.
6. Turn the engine off and wait approximately one minute. Remove the level/fill plug and recheck the lubricant level. The level should be visible at the level hole. If lubricant is not visible, add recommended lubricant until the level is visible at the level hole.
7. Inspect the area around the drain plug for leaks.

## Engine Oil

1. Move the ATV outdoors and start and warm up the engine. Shut the engine off; then place a drain pan under the engine oil drain plug located on the left-side rear of the engine under the kick starter.

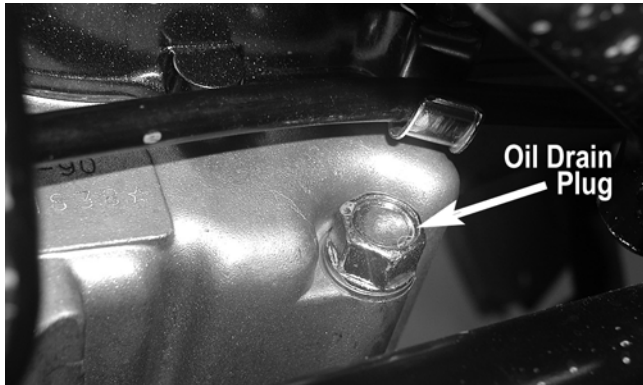

CD634A

2. Remove the oil drain plug and drain the engine oil into the pan; then install the oil drain plug and tighten securely.
3. Move the drain pan to the right-front of the engine and remove the oil screen/filter cap. Account for a screen, spring, and O-ring.

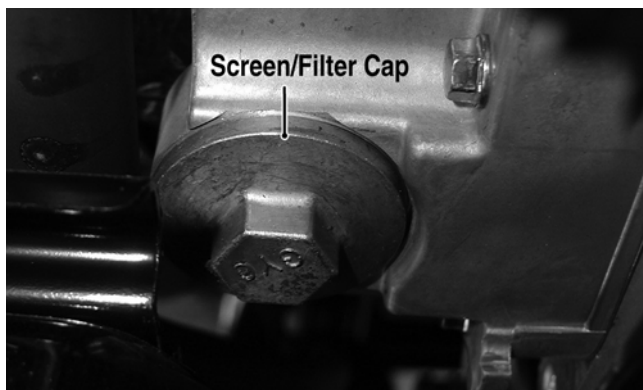

KM040A



CD628

4. Clean the oil screen in parts-cleaning solvent using a brush; then install the screen, spring, and cap making sure the O-ring is seated properly in the cap. Tighten to specifications (see Section 10).



CD626

5. Remove the oil level stick and pour the recommended amount and viscosity oil into the engine; then install the oil level stick.

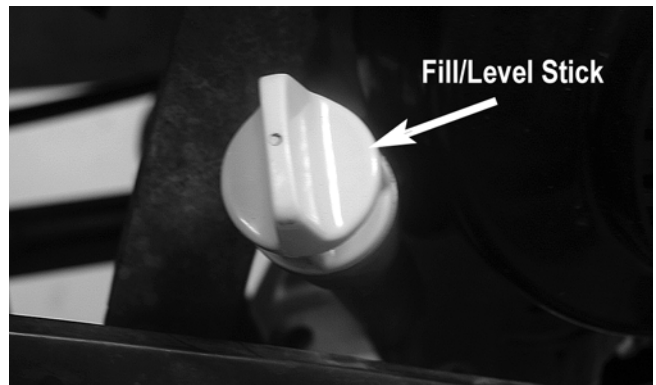

CD629A

6. Start and warm up the engine.
7. Shut the engine off and allow to stand for 2-3 minutes.
8. Remove the oil level stick and wipe with a clean cloth.
9. Insert the oil level stick until the threads touch the engine.

■ **NOTE:** The oil level stick should not be threaded into the engine for checking the oil.

10. Remove the oil level stick; the engine oil level should be above the illustrated "L" mark but not any higher than the illustrated "F" mark.

### CAUTION

Do not over-fill the engine with oil. Always make sure that the oil level is above the "L" mark but no higher than the "F" mark.

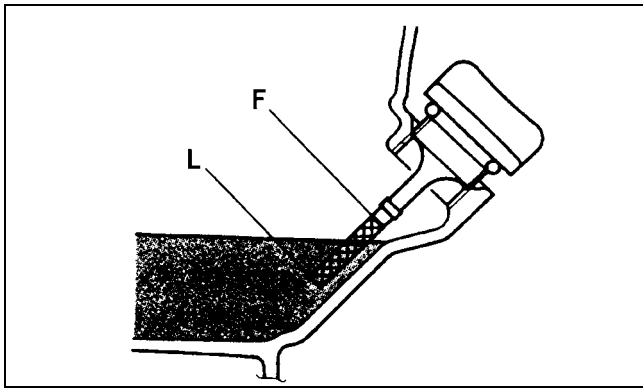

ATV-0100

11. Inspect the area around the drain plug and oil screen/filter cap for leaks.

---

## Tires

---

### TIRE SIZE

The ATV is equipped with low-pressure tubeless tires of the size and type listed (see Section 1). Do not under any circumstances substitute tires of a different type or size.

#### ⚠ WARNING

Always use the size and type of tires specified.  
Always maintain proper tire inflation pressure.

### TIRE INFLATION PRESSURE

Front and rear tire inflation pressure should be 0.21 kg-cm<sup>2</sup> (3.0 psi).

A low-pressure gauge is provided in the tool kit to measure the air pressure in the tires. Check the air pressure in all tires before each use of the ATV.

---

## Steering Components

---

The following steering components should be inspected periodically to ensure safe and proper operation.

- A. Handlebar grips worn, broken, or loose.
- B. Handlebar bent, cracked, and an equal and complete full-left and full-right turn capability.
- C. Steering post bearing assembly/bearing housing broken, worn, or binding.
- D. Ball joints worn, cracked, or damaged.

- E. Tie rods bent or cracked.
- F. Knuckles worn, cracked, or damaged.
- G. Cotter pins damaged or missing.

---

## Drive Chain/Sprockets

---

### CHECKING DRIVE CHAIN/SPROCKETS

The following drive system components should be inspected periodically to ensure proper operation.

- A. Chain (excessive stretch or slack).
- B. Sprockets (excessive wear/hooks, missing, or broken teeth).

### ADJUSTING DRIVE CHAIN

To adjust the drive chain, see Section 6.

---

## Suspension/Shock Absorbers/Bushings

---

The following suspension system components should be inspected periodically to ensure proper operation.

- A. Shock absorber rods bent, pitted, or damaged.
- B. Rubber damper cracked, broken, or missing.
- C. Shock absorber body damaged, punctured, or leaking.
- D. Shock absorber eyelets broken, bent, or cracked.
- E. Shock absorber eyelet bushings worn, deteriorated, cracked, or missing.
- F. Shock absorber spring broken or sagging.

---

## Nuts/Bolts/Cap Screws

---

Tighten all nuts, bolts, and cap screws. Make sure rivets holding components together are tight. Replace all loose rivets. Care must be taken that all calibrated nuts, bolts, and cap screws are tightened to specifications. For proper torque values, see Section 10.



---



---

## Ignition Timing

---

The ignition timing cannot be adjusted; however, verifying ignition timing can aid in troubleshooting other components. To verify ignition timing, use the following procedure.

1. Attach the Timing Light (p/n 0644-296) to the spark plug high tension lead; then remove the timing inspection plug from the right-side crankcase cover.
2. Using the Arctic Cat Tachometer (p/n 0644-275), start the engine and run at 4000 RPM; ignition timing should be 28° BTDC ("F" mark).
3. Install the timing inspection plug.

If ignition timing cannot be verified, the rotor may be damaged, the key may be sheared, the trigger coil bracket may be bent or damaged, or the CDI unit may be faulty.

---



---

## Brakelight

---

Each time the ATV is used, the brakelight should be checked for proper function. Rotate the ignition switch to the ON position and compress both brake levers. The brakelight should illuminate.

To replace the brakelight bulb, use the following procedure.

1. Remove the two screws and remove the lens cover.
2. Remove the bulb by pushing it in and turning it counterclockwise.
3. Install the new bulb by pushing it in and turning it clockwise.
4. Install the lens cover.

 **CAUTION**

**Tighten the lens cover screws only until they are snug.**

---



---

## Switches

---

Each time the ATV is used, switches should be checked for proper operation. Use the following list for reference.

- A. Ignition switch — engine will start (with brake lever compressed).
- B. Emergency stop switch — engine will stop.
- C. Brakelight switch — brakelight will illuminate with brake lever(s) compressed.

---



---

## Frame/Welds

---

The frame and welds should be checked periodically for damage, bends, cracks, deterioration, broken components, and missing components. If replacement or repair constitutes removal, see Section 8.

---



---

## Electrical Connections

---

The electrical connections should be checked periodically for proper function. In case of an electrical failure, check fuse, connections (for tightness, corrosion, damage), and/or bulb. If an electrical component needs to be tested for proper function, see Section 5.

---



---

## Brake Systems

---

 **WARNING**

**After servicing components that are brake-related, ALWAYS check and adjust brakes as necessary before operating the ATV.**

Although the brake systems have been adjusted at the factory, the brakes should be checked for proper operation. The brakes must be maintained to be fully functional.

## CHECKING FRONT WHEEL BRAKE

1. With the engine off, compress the right-hand (front) brake lever and attempt to move the ATV.
2. If the front wheels are locked, it is adjusted properly.
3. If the front wheels are not locked or if only one wheel locks, adjustment is necessary.

## CHECKING REAR WHEEL BRAKE

1. With the engine off, compress the left-hand (rear) brake lever and attempt to move the ATV.
2. If the rear wheels are locked, it is serviceable.
3. If the rear wheels are not locked, bleed the brake system or replace the pads as necessary.

## ADJUSTING FRONT WHEEL BRAKE

1. Raise the ATV enough to allow the front wheels to spin freely.
2. Loosen both jam nuts on the right-hand (front) brake lever. Turn both cable adjusters counter-clockwise until both front wheels do not spin freely.

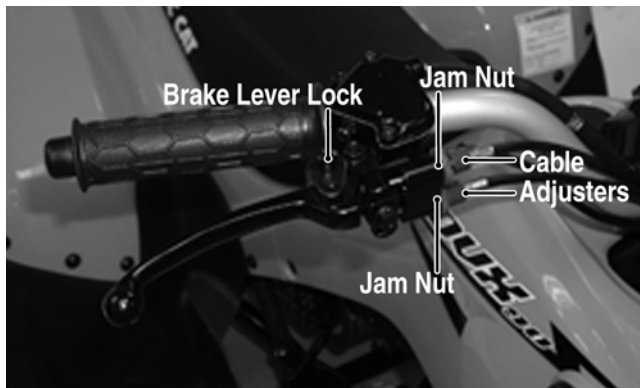

KM024B

3. Turn both cable adjusters in 1/4 turn increments (clockwise) until the wheels spin with a very slight amount of drag.
4. Lower ATV; then push it forward and compress the brake lever.
5. If the front wheels lock evenly, adjustment is correct.
6. If the front wheels do not lock evenly, additional adjustment is necessary.
7. Once proper adjustment is obtained, tighten the jam nuts.

## MEASURING/REPLACING BRAKE SHOES/PADS

### Removing Front Brake Shoes

1. Support the ATV on a support stand.
2. Remove both front wheels and account for the cap screws.
3. Remove the cotter pins, castle nuts, and washers; then remove the brake drums/wheel hubs.
4. Loosen the brake shoe return spring; then remove the brake shoes.



MD2042

### Removing Rear Brake Pads

1. Remove the two cap screws securing the brake caliper to the axle housing; then lift the caliper off the disc.

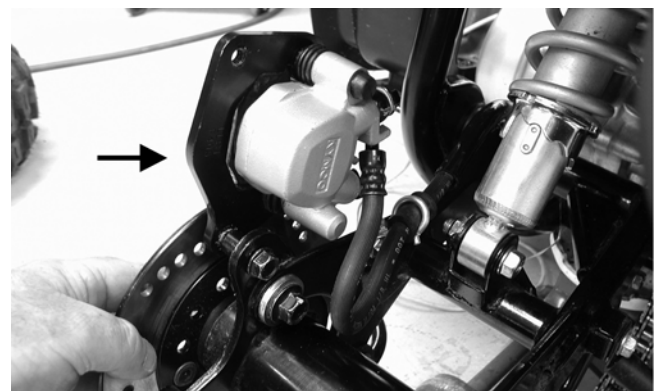

KM234A

2. Depress the holder pins and disengage and remove the outer pad; then remove the inner pad. Account for the spring clip.



KM221A

### Inspecting and Measuring

1. Inspect the pads for gouges, chips, or wear.
2. Inspect the disc for gouges, grooves, cracks, and warpage.
3. Using a calipers, measure the thickness of each brake pad.
4. If the thickness of any brake pad is less than 1.0 mm (0.039 in.), the brake pads must be replaced.

■ **NOTE:** The brake pads should be replaced as a set.

### Installing Front Brake Shoes

1. Place the brake shoes onto the backing plate over the stationary pivot pin and rotating cam.
2. Install the brake return spring.



MD2044

3. Install the wheel hub, washer, and castle nut. Tighten the castle nut to specifications (see Section 10); then install a new cotter pin.
4. Install the wheel. Tighten to specifications (see Section 10).
5. Repeat this procedure for the other side; then adjust the brake (see Adjusting Front Wheel Brake in this sub-section).

6. Remove the ATV from the support stand.

### Installing Rear Brake Pads

1. Place the inner pad spring clip into position and install the inner brake pad; then install the outer pad onto the holder pins.

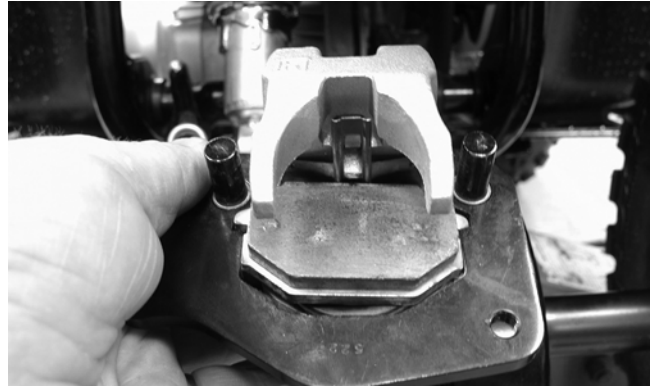

KM214

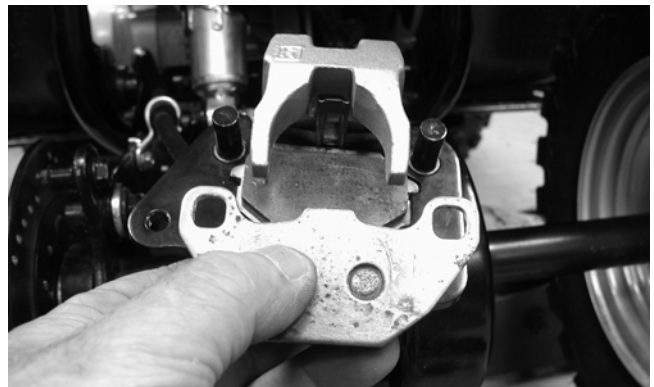

KM222

2. Place the assembled caliper into position on the disc; then secure with the two cap screws coated with blue Loctite #243. Tighten to specifications (see Section 10).

■ **NOTE:** Always compress the hydraulic brake lever several times to check that the brakes are firm. If the brakes are not firm, bleeding the system will be necessary (see BLEEDING in this sub-section).

### BLEEDING

To bleed the brake system, use the following procedure.

1. Remove the brake fluid reservoir cover and fill the reservoir with DOT 4 Brake Fluid.
2. Install and secure the cover.
3. Remove the protective cap from the bleed screw and connect one end of a clear hose to the bleed screw and direct the other end into a suitable container.



KM207A



AF637D

4. Slowly compress the brake lever several times; then while holding slight pressure on the brake lever, open the bleed screw and watch for air bubbles in the hose. Close the bleed screw before releasing the brake lever. Repeat this procedure until no air bubbles are present.

■ **NOTE:** During the bleeding procedure, watch the reservoir sight glass to make sure there is always a sufficient amount of brake fluid in the reservoir. Failure to maintain sufficient amount of fluid in the reservoir will result in air being in the system.

5. Repeat step 4 until the brake lever is firm.

---

---

## Replacing Drive Belt

---

### REMOVING

1. Remove the eight Phillips-head cap screws and four cap screws securing the footrest cover to the footrest and front and rear fenders; then remove footrest cover.
2. Remove the cooling duct.
3. Remove the eight cap screws securing the drive clutch cover; then remove the cover. Account for a gasket and two alignment pins.

■ **NOTE:** The gasket does not need to be removed unless it is being replaced or unless additional servicing is being done requiring its removal.

4. Remove the nut securing the stationary drive sheave to the crankshaft; then remove the stationary drive sheave. Account for a washer, kick starter ratchet, and cooling fan.



CD621

5. Open the movable sheave on the driven clutch assembly with a suitable pry bar or wedge; then remove the drive belt.



CD624

### INSTALLING

1. If removed, place the gasket and two alignment pins into position on the crankcase.
2. Spread the faces of the driven clutch with a suitable pry bar or wedge; then when the faces are separated, insert the drive belt.

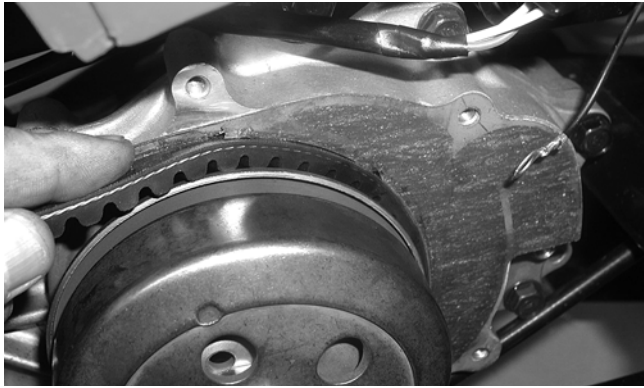

CD624

■ **NOTE:** If the drive belt has an arrow stamped on the outer face, it should point forward (direction of rotation).

3. Pinch the drive belt together near its center and slide the stationary drive sheave over the crankshaft. Install the washer, kick starter ratchet, and cooling fan. Secure the stationary drive sheave with a nut (threads coated with red Loctite #271). Tighten the nut to specifications (see Section 10).



CD623

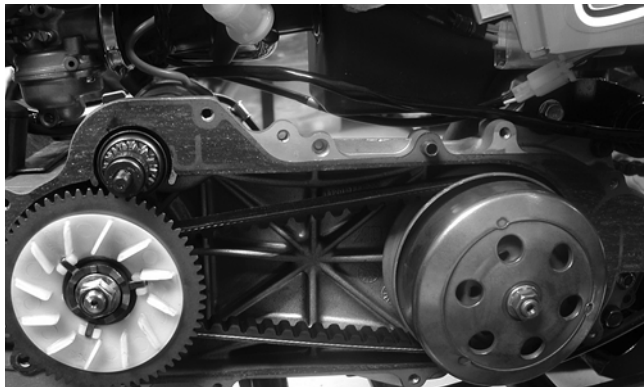

CD619

4. Rotate the drive belt and sheaves until the drive belt is flush with the top of the driven clutch.

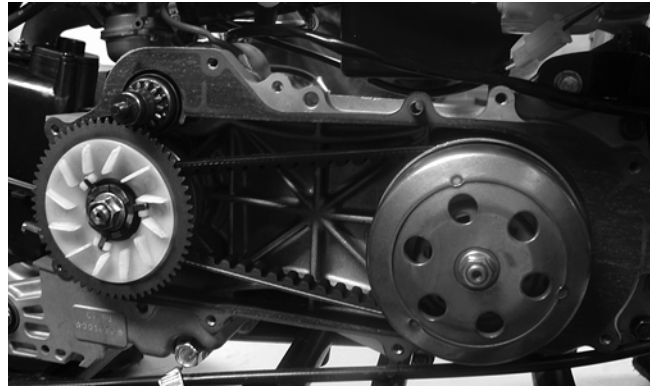

CD620

5. Place the drive clutch cover and one rear brake cable tab into position; then secure with the eight cap screws.



CD617

6. Tighten the cover cap screws to specifications (see Section 10).
7. Install the cooling duct.
8. Place the footrest cover into position and secure it to the footrest with the Phillips-head cap screws. Tighten to specifications (see Section 10).
9. Secure the footrest cover to the front and rear fenders with the Phillips-head cap screws and four cap screws. Tighten to specifications (see Section 10).

2

# SECTION 3 - ENGINE/TRANSMISSION

---

---

## Table of Contents

---

Engine/Transmission .....	3-2
Specifications .....	3-2
Y-12 (Table of Contents) .....	3-3

## Engine/Transmission

This section has been organized into sub-sections which show a progression for the complete servicing of the Arctic Cat Y-12 engine/transmission.

■ **NOTE:** Arctic Cat recommends the use of new gaskets, lock nuts, and seals and lubricating all internal components when servicing the engine/transmission.

■ **NOTE:** Some photographs and illustrations used in this section are used for clarity purposes only and are not designed to depict actual conditions.

■ **NOTE:** Critical torque specifications are located in Section 10.

## Specifications\*

Piston Ring End Gap (Installed)	(top)	0.15-0.30 mm (0.006-0.012 in.)
	(2nd)	0.30-0.45 mm (0.012-0.018 in.)
	(oil)	0.2-0.7 mm (0.008-0.028 in.)
Piston Pin Outside Diameter (Min)		12.96 mm (0.51 in.)
Piston Pin Bore (Max)		13.03 mm (0.513 in.)
Piston Skirt/Cylinder Clearance (Max)		0.10 mm (0.0039 in.)
Cylinder Head Distortion (Max)		0.05 mm (0.002 in.)
Cylinder Bore Trueness		50.00-50.05 mm (1.968-1.970 in.)
Connecting Rod (Small End Inside Diameter) (Max)		13.06 mm (0.514 in.)
Connecting Rod (Small End Deflection) (Max)		0.40 mm (0.0157 in.)
Connecting Rod (Big End Side to Side) (Max)		0.05 mm (0.002 in.)
Crankshaft (Run-Out) (Max)		0.10 mm (0.004 in.)
Camshaft Lobe (Intake) (Min)		26.33 mm (1.037 in.)
Camshaft Lobe (Exhaust) (Min)		25.65 mm (1.01 in.)
Rocker Arm to Shaft Clearance (Max)		0.10 mm (0.004 in.)
Valve Spring Free Length (Intake) (Min)		30.8 mm (1.21 in.)
Valve Spring Free Length (Exhaust) (Min)		30.5 mm (1.20 in.)
Intake Valve Stem to Guide Clearance (Max)		0.06 mm (0.002 in.)
Exhaust Valve Stem to Guide Clearance (Max)		0.08 mm (0.003 in.)
Oil Pump Outer Rotor to Body Clearance (Max)		0.25 mm (0.010 in.)
Oil Pump Outer to Inner Rotor Clearance (Max)		0.20 mm (0.008 in.)
Oil Pump Rotor End Clearance (Max)		0.12 mm (0.005 in.)
V-Belt Width (Min)		16.5 mm (0.65 in.)
Centrifugal Clutch Housing (Max)		107.5 mm (4.23 in.)
Centrifugal Clutch Lining Thickness (Min)		1.0 mm (0.039 in.)
Driven Pulley Spring Free Length (Min)		154.6 mm (6.087 in.)
Roller Guide Diameter (Min)		15.4 mm (0.606 in.)
Movable Drive Face Collar (Max)		24.06 mm (0.95 in.)

\*Specifications subject to change without notice.

## Y-12 (Table of Contents)

Removing Engine/Transmission.....	3-3
Disassembling Engine/Transmission.....	3-6
Servicing Components.....	3-16
Assembling Engine/Transmission .....	3-22
Installing Engine/Transmission.....	3-34

## Removing Engine/Transmission

1. Remove the seat, front and rear fenders, and left and right floor panels.
2. Remove the negative cable from the battery; then remove the positive cable. Remove the battery.

### **WARNING**

Battery acid is harmful if it contacts eyes, skin, or clothing. Care must be taken whenever handling a battery.



CD578

3. Drain the transmission oil.

■ **NOTE:** The drain plug is an 8 mm cap screw with a copper washer located at the left-rear of the transmission.

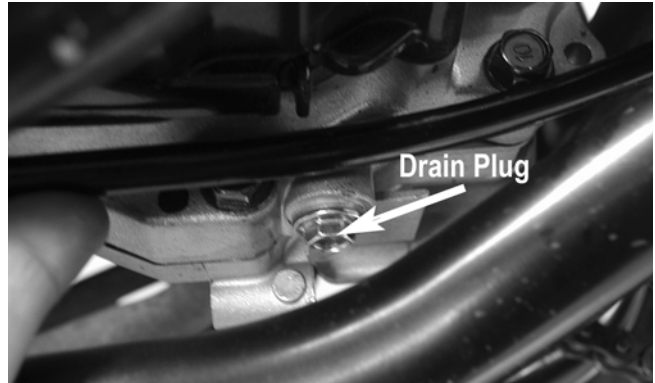

CD632A

4. Drain the engine oil.

■ **NOTE:** The oil drain plug is a 12 mm cap screw with a copper washer located at the lower-left-front of the crankcase.

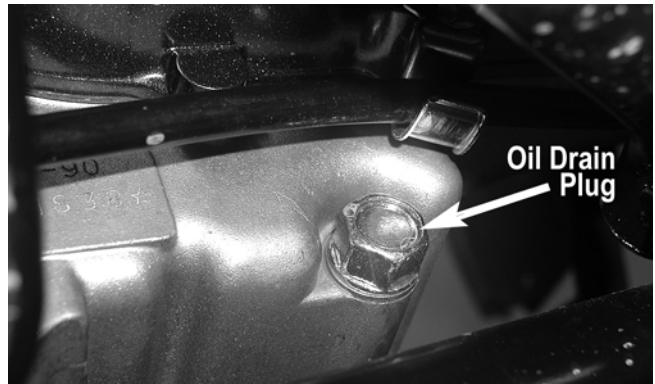

CD634A

5. Remove the engine ground wire from the starter motor.



KM546A

6. Remove the two cap screws securing the gas tank; then remove the gas tank. Tilt the gas tank to drain the gasoline into an appropriate container; then set it aside making sure it is properly sealed.

**3**



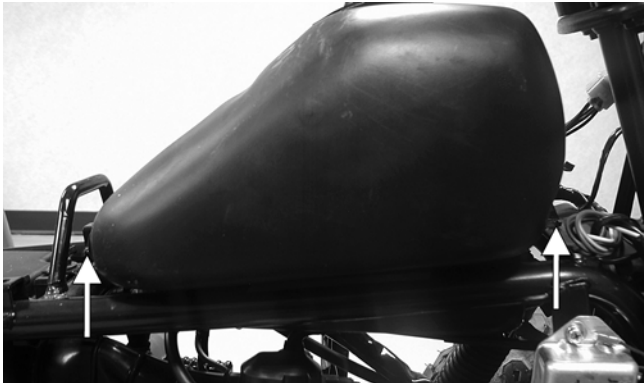

CD636A

**AT THIS POINT**

Remove the carburetor (see Section 4 - Carburetor in this manual).

7. Mark the gas hoses for installing purposes; then remove the gas hoses from the fuel valve noting where each one is attached.

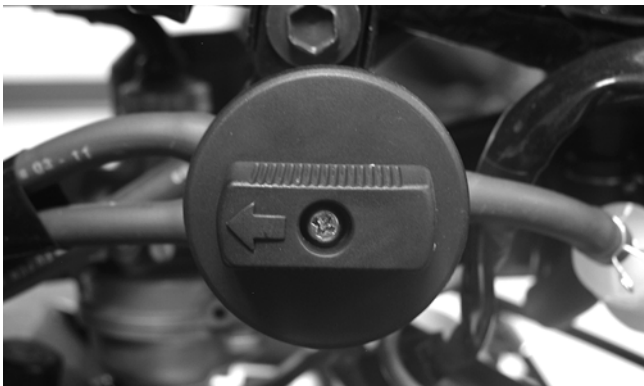

CD643

8. Remove the air filter housing assembly.



DSC02103

9. Remove two nuts securing the intake manifold to the cylinder head.



DSC02099

10. Remove the intake manifold. Account for the gasket.

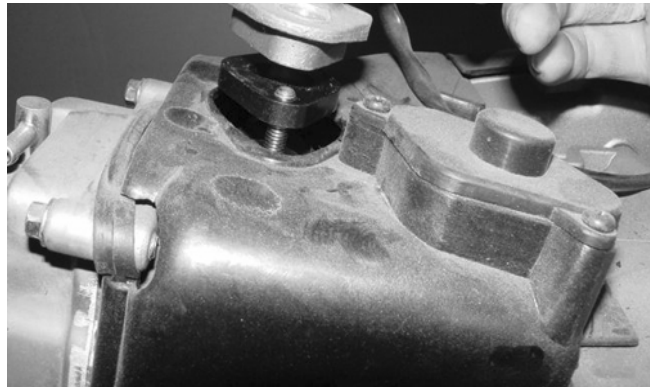

DSC02043

11. Remove two 6 mm and one 8 mm cap screws securing the exhaust front pipe protective cover.



DSC02105

12. Remove the tailpipe at the flange and at the hanging mount at the rear. Account for a flange gasket.



DSC02106

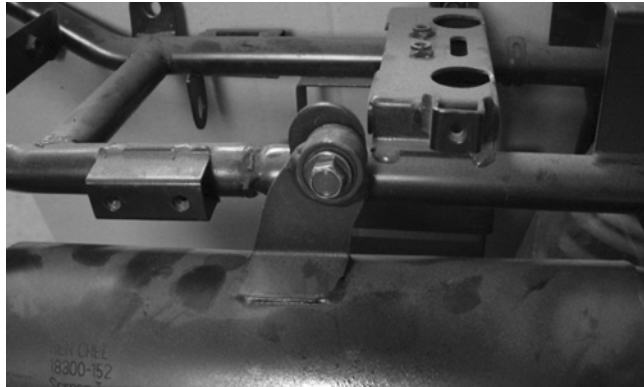

DSC02107

13. Remove the drive chain master link clip from the master link; then remove the link plate and link. Remove the chain.



DSC02108

14. Disconnect the starter motor wire and AC generator wire connectors on the left side of the frame.



DSC02033

15. Remove the spark plug cap; then disconnect all engine-related electrical connectors on the left side of the frame.



CD646

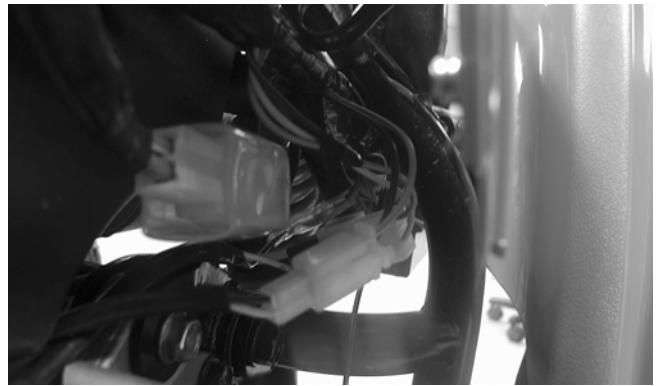

CD645

16. Remove the engine mounting bracket at the front of the engine and the two mounting cap screws at the rear.

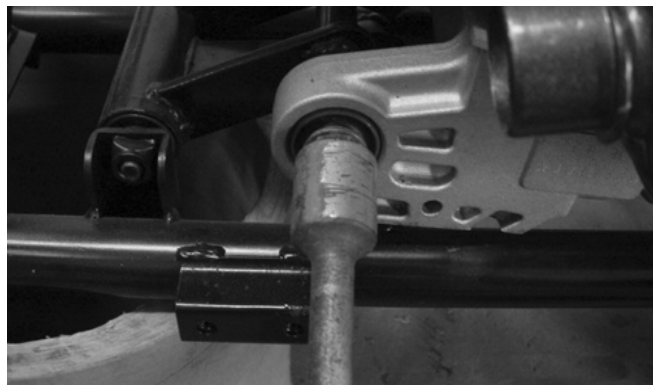

DSC02030

3

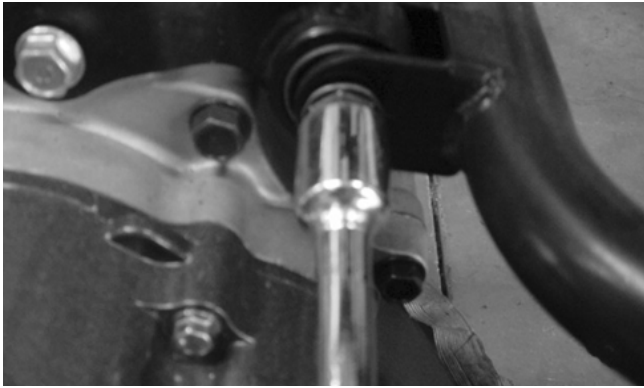

DSC02028

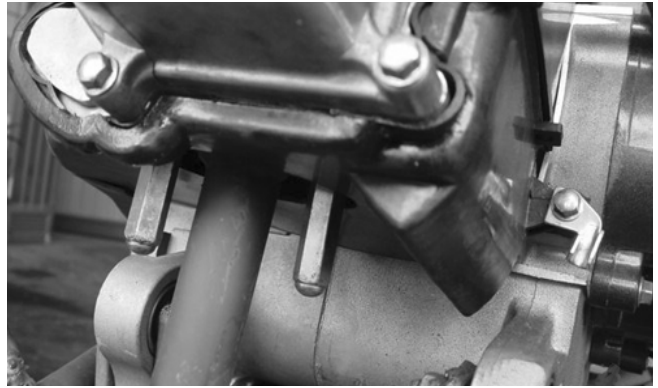

DSC02039

2. Remove two cap screws and two self-tapping screws securing the cooling fan cover and remove the cover.

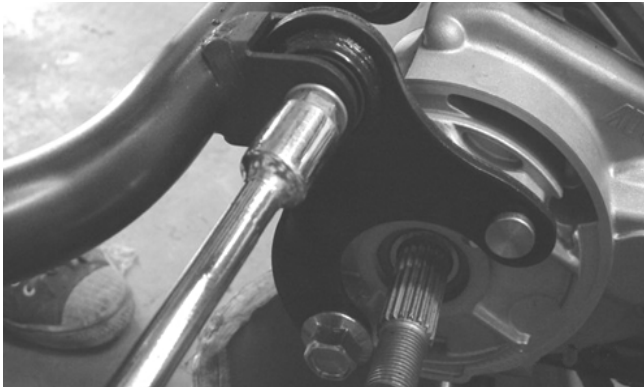

DSC02029

17. Remove the engine.

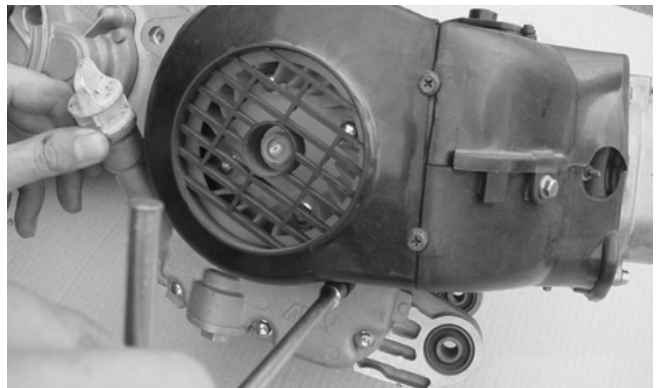

DSC02046

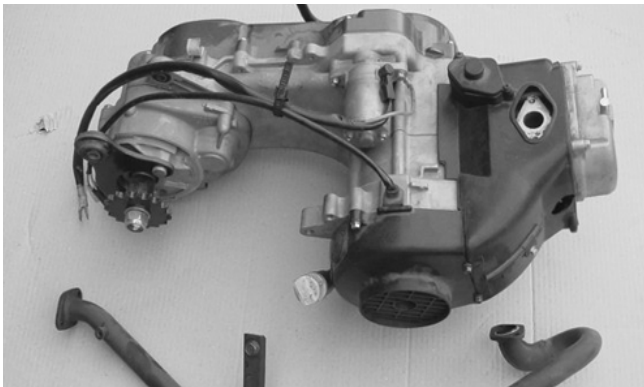

DSC02045

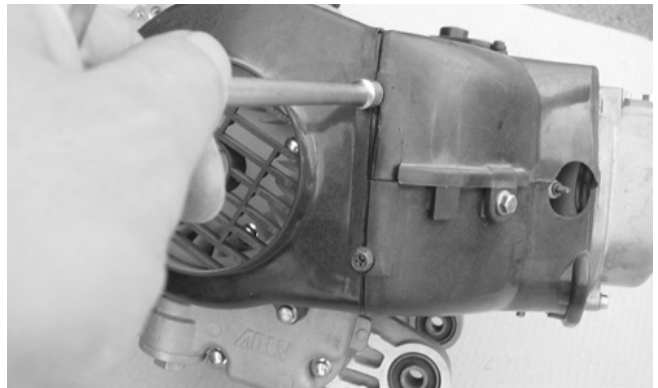

DSC02047

3. Remove three cap screws from the cooling shroud; then remove the top and bottom shroud from the head/cylinder assembly.

---

## Disassembling Engine/Transmission

---

1. Remove the two cap screws securing the exhaust pipe to the cylinder; then remove the pipe.

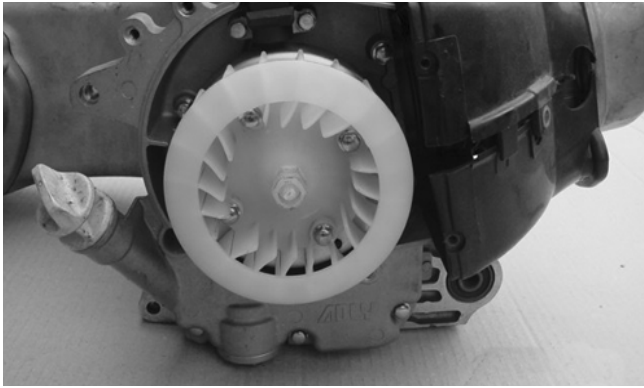

DSC02048

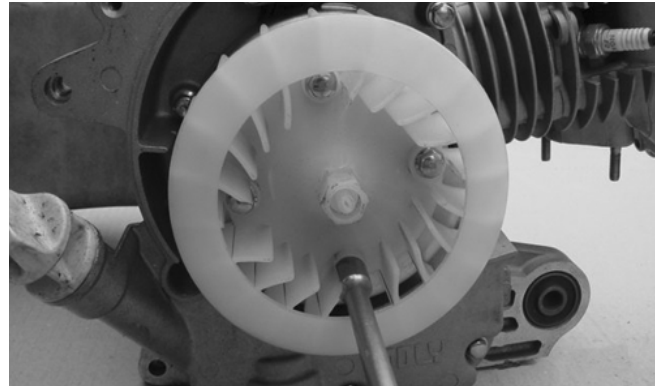

DSC02055

6. Remove the nut securing the flywheel. Account for a washer.

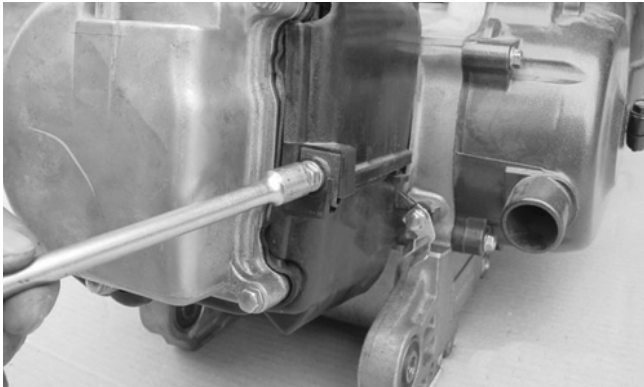

DSC02051

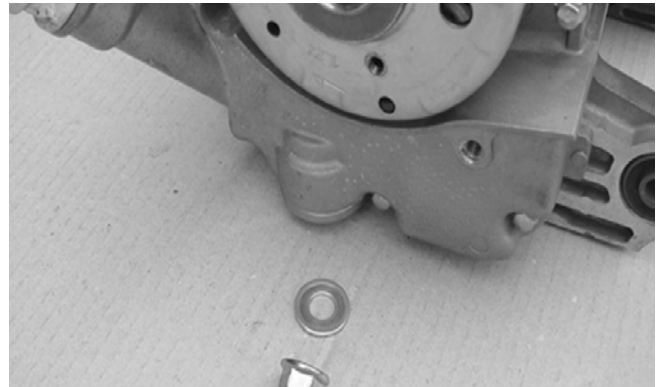

DSC02057

7. Using an appropriate puller, remove the flywheel. Remove the key from the crankshaft.

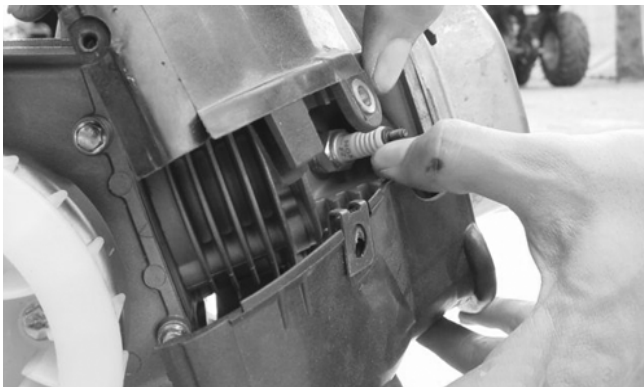

DSC02052

4. Remove the cylinder head shroud seal.

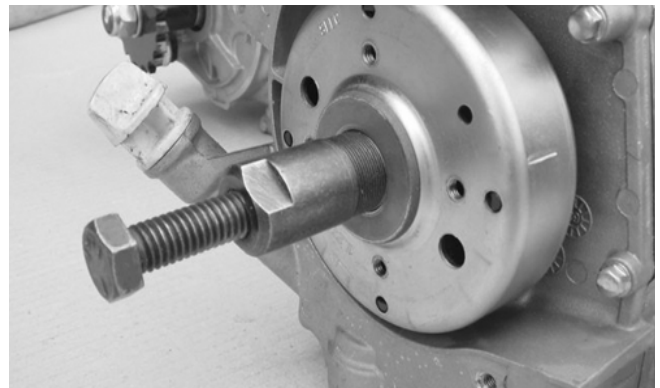

DSC02058

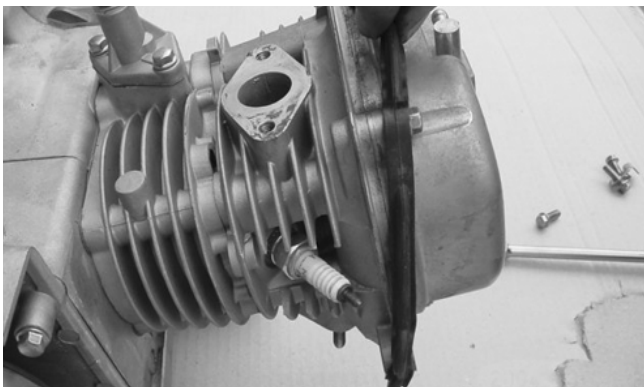

DSC02053

5. Remove the cooling fan from the flywheel.

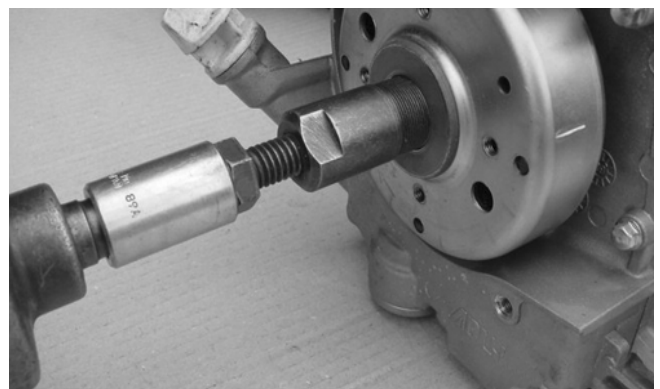

DSC02059

3

8. Remove the oil screen/filter cap and account for the spring and filter screen.

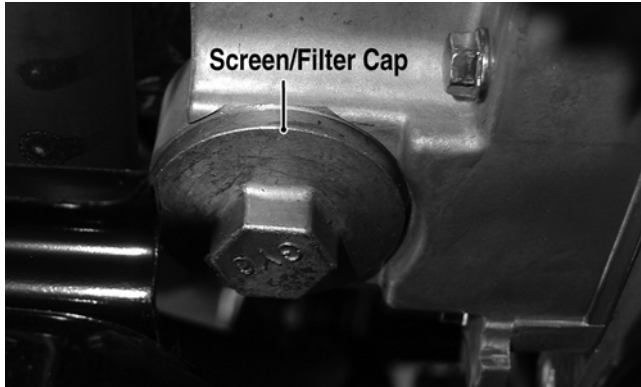

KM040A

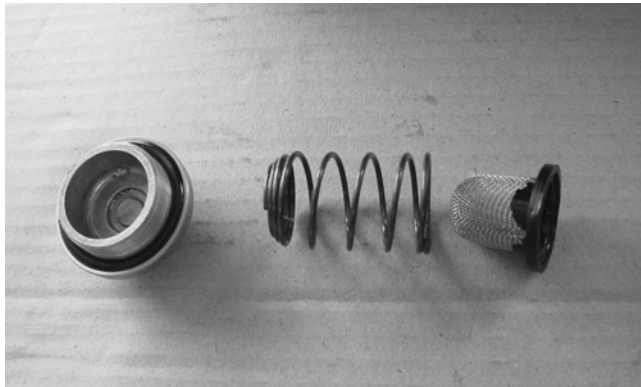

DSC02248

9. Remove the cable tie securing the stator wire.

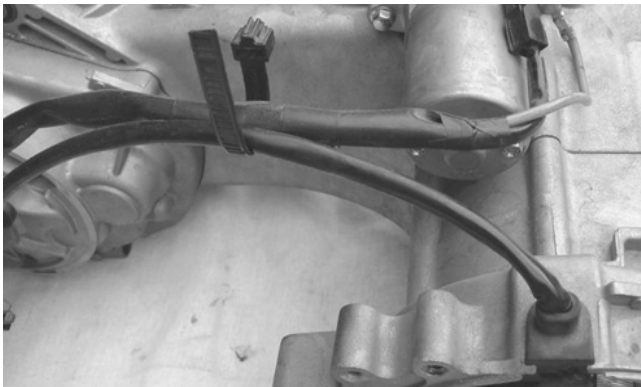

DSC02088

10. Remove four cap screws securing the stator and source coil; then remove the stator.

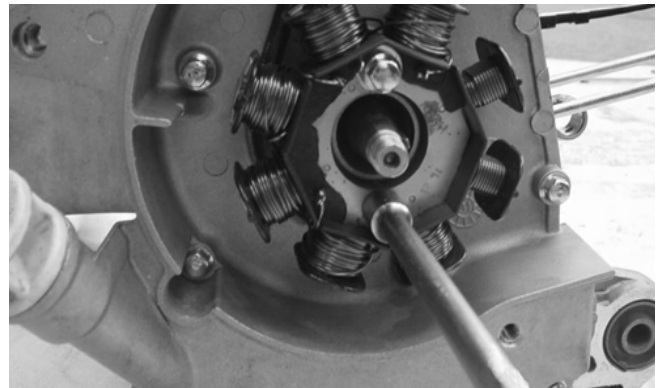

DSC02089

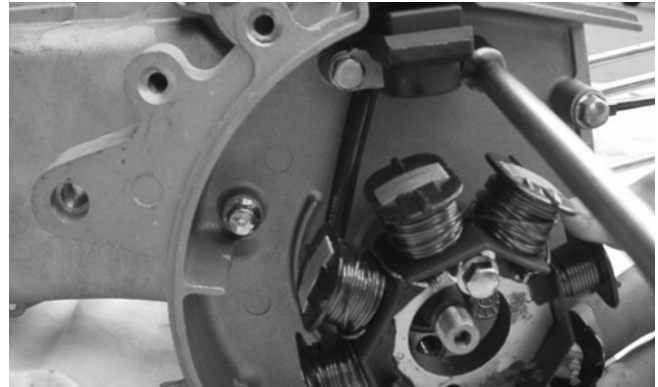

DSC02090

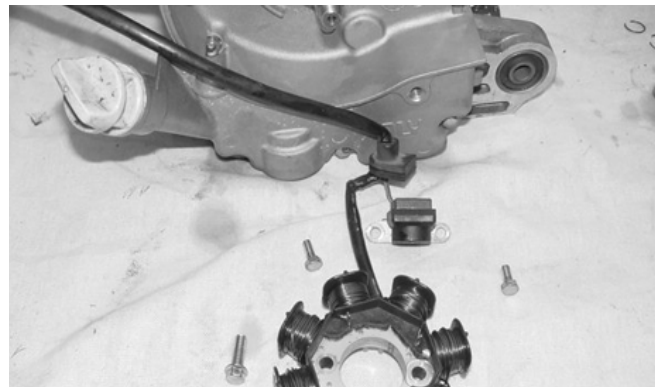

DSC02091

11. Remove the two cap screws securing the starter motor; then remove the starter motor. Account for an O-ring.

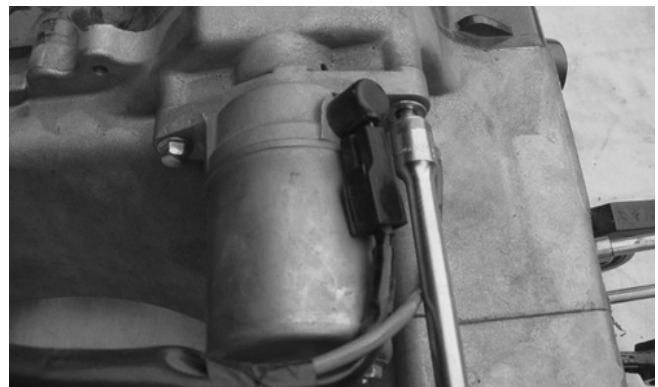

DSC02093



DSC02095

12. Remove four cap screws securing the cylinder head cover and remove the cover. Account for the O-ring seal.

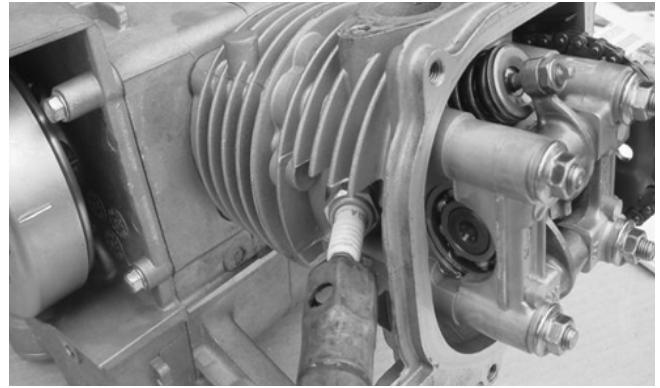

DSC02064

14. Remove four nuts securing the cylinder head to the cylinder.

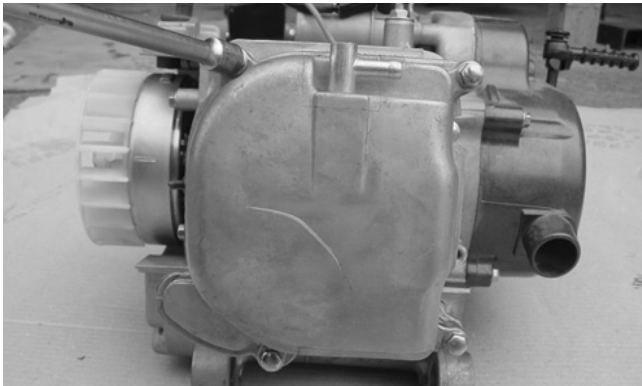

DSC02054

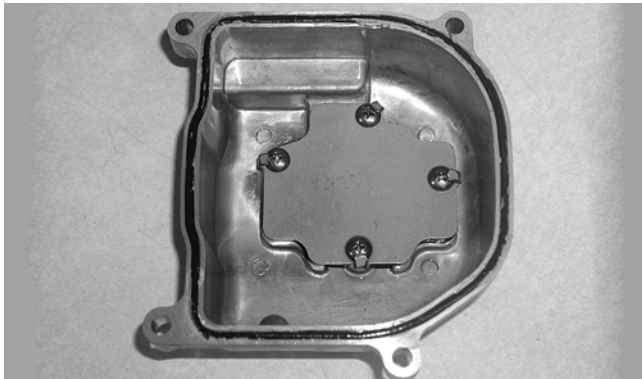

CD655

13. Using compressed air, blow any debris from around the spark plug; then remove the spark plug.

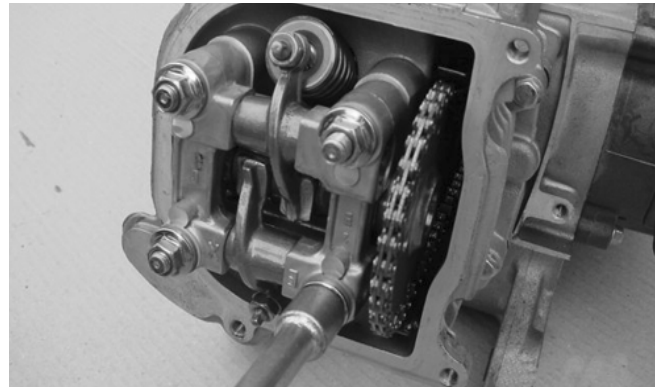

DSC02066

15. Remove the two cap screws securing the cam chain tensioner to the cylinder; then remove the chain tensioner. Account for the gasket.

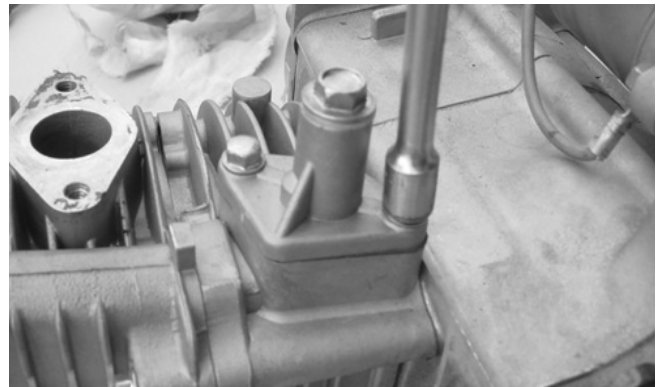

DSC02068

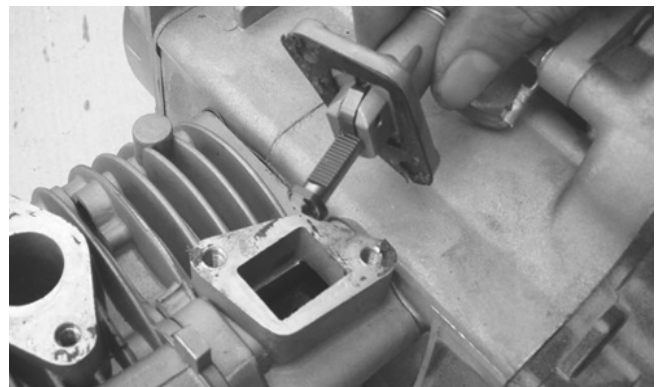

DSC02070

3

**⚠ WARNING**

Always wear safety glasses when using compressed air.

16. Remove the chain from the camshaft sprocket; then remove the rocker arm assembly and camshaft. Account for two alignment pins underneath the rocker arm assembly.

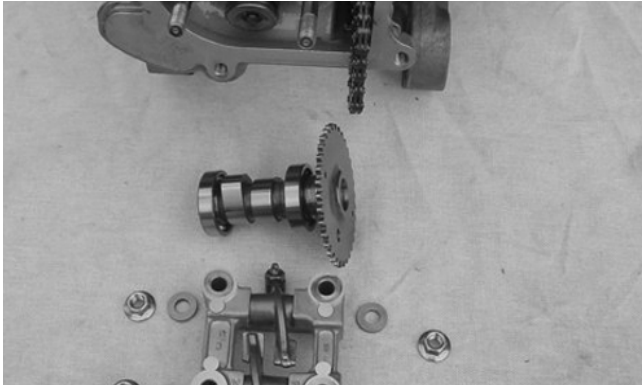

DSC02073

17. Remove two cap screws securing the left side of the cylinder head and remove the cylinder head assembly. Discard the head gasket.

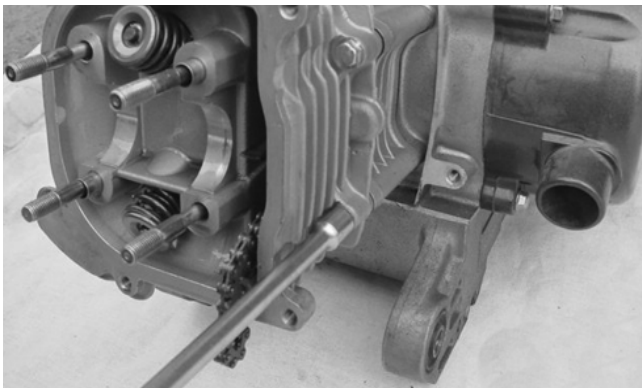

DSC02074

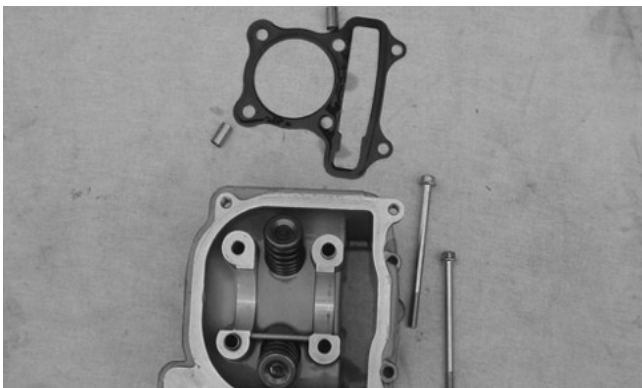

DSC02077

18. Remove the bottom chain guide; then remove the cylinder. Account for two dowel pins located between the crankcase and the cylinder.

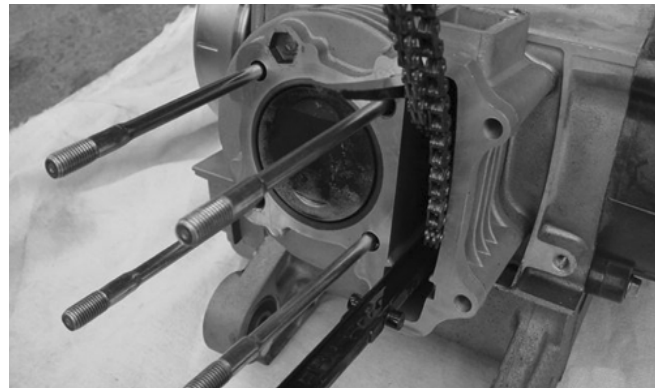

DSC02078

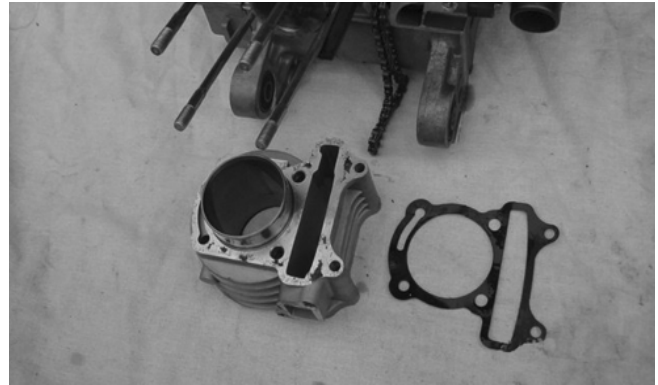

DSC02084

19. Using a needle-nose pliers, remove the piston pin circlips; then remove the piston pin. Account for the circlips.

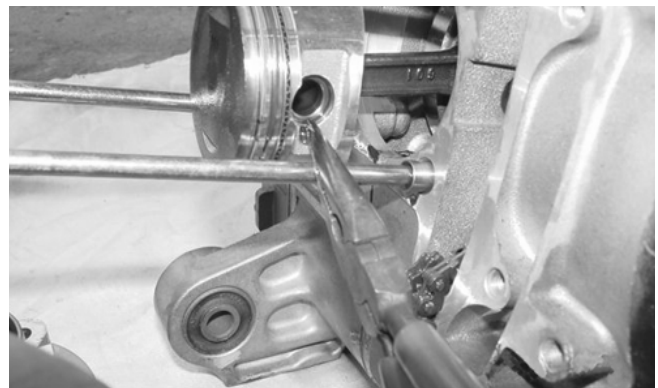

DSC02086

20. If replacing the rings, remove them from the piston by lifting one end of the ring out of the groove and working it out in a circular motion.

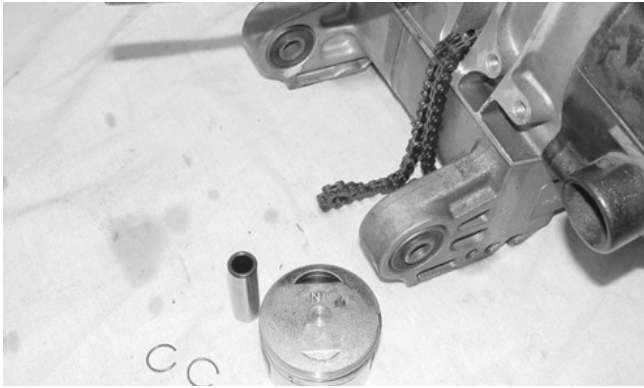

DSC02087

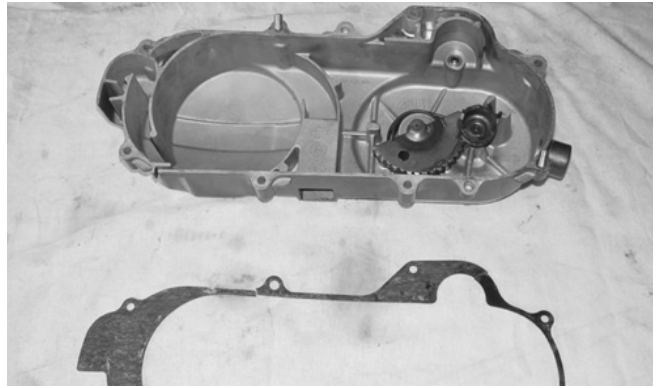

DSC02120



DSC02174

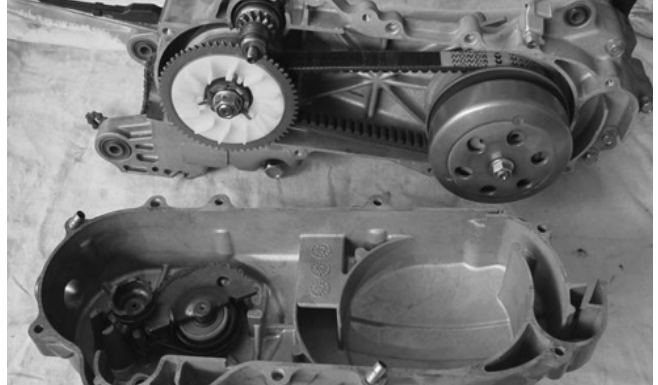

DSC02122



DSC02175

21. Remove the eight cap screws securing the V-belt cover; then remove the V-belt cover. Account for two alignment pins, a gasket, and the rear brake cable clip.

22. Remove the fixed drive face from the crankshaft. Account for the washer, ratchet, and cooling fan.

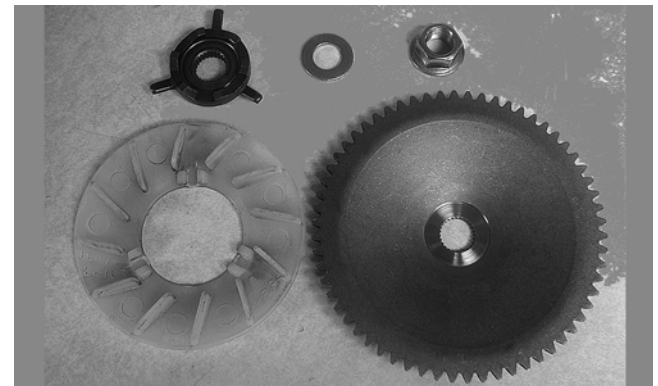

CD621

23. Remove the movable drive face. Account for the ramp plate, the six roller guides, and the drive face collar.

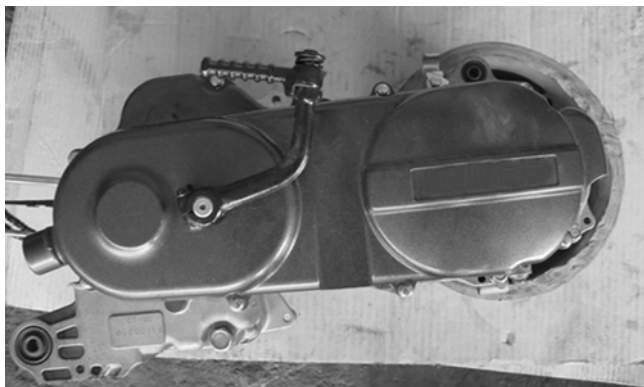

DSC02118

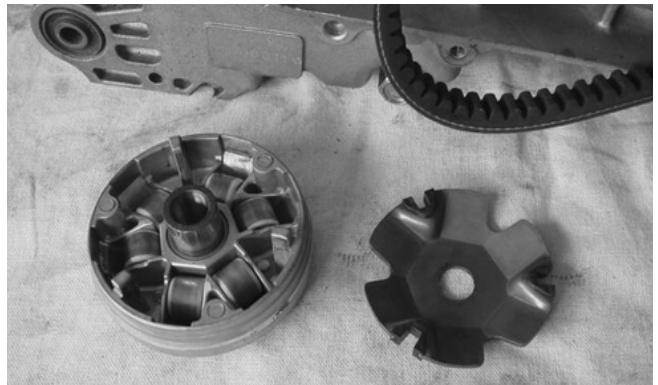

DSC02128

3



24. Remove the kick starter driven gear. Account for the washer and the spring.



DSC02127

25. Remove the 10 mm nut securing the centrifugal clutch housing.



DSC02130



DSC02131

26. Remove the centrifugal clutch/driven pulley assembly as a unit together with the belt.



DSC02132

27. Remove the 28 mm nut securing the centrifugal clutch/driven pulley components.

**⚠ WARNING**

There is a spring between the centrifugal clutch assembly and the movable driven face. Care must be taken when removing the 28 mm nut to relieve spring tension gradually to avoid injury.



DSC02133



DSC02135

28. Remove the 14 mm nut securing the countershaft sprocket to the countershaft.

■ **NOTE:** When removing the countershaft sprocket with the engine out of the frame, it will be necessary to hold the sprocket in a vise or in another suitable holding device. Account for the washer and spacer.



DSC02136

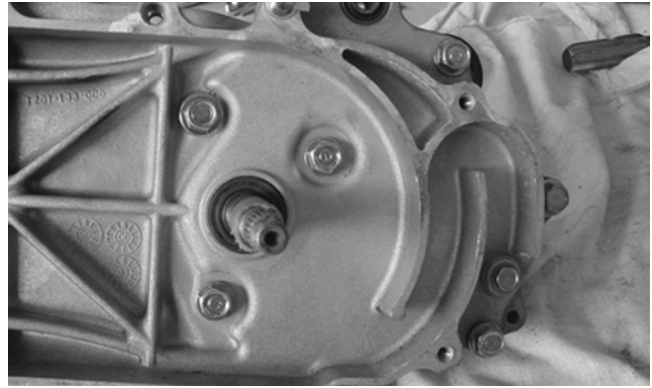

DSC02140

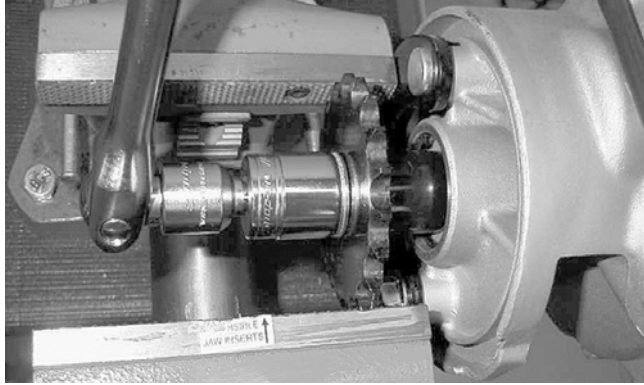

MD1894

30. Remove the transmission case cover and gears as a unit. Discard the gasket. Note the location of two longer cap screws and two alignment pins for assembling purposes.



DSC02137



DSC02142

3

**AT THIS POINT**

If the technician's objective is to inspect the reduction gears, see Section 6 - Reduction Gears.

29. Remove the seven cap screws securing the cover to the transmission case.



DSC02144

31. Remove the bearing and inner seal from the output side of the transmission case.



DSC02145

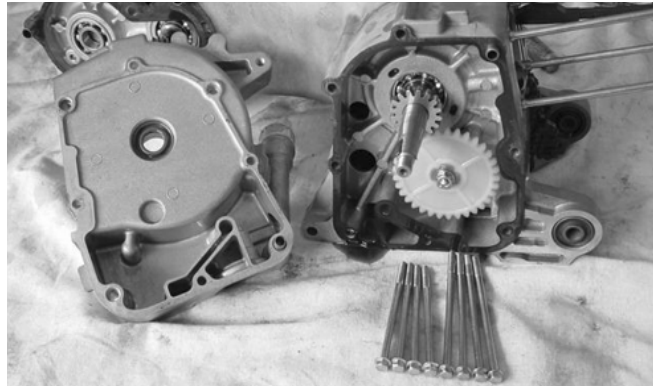

DSC02149



DSC02146

32. Remove the eight cap screws from the right-side crankcase cover.

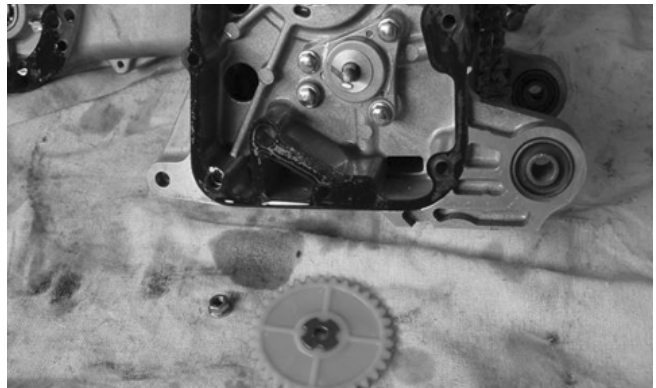

DSC02151

35. Remove the three cap screws securing the oil pump assembly; then remove the oil pump assembly. Account for two O-rings and one alignment pin.

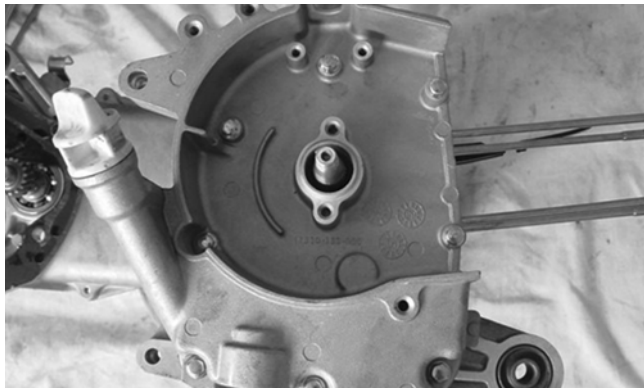

DSC02148

33. Remove the right-side crankcase cover. Account for two dowel pins. Note the location of the four short and four long cap screws for assembling purposes.

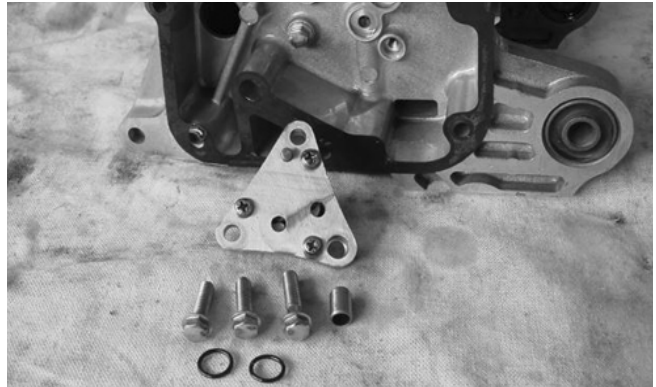

DSC02152

36. Remove the one remaining cap screw securing the left-side and right-side crankcase halves.

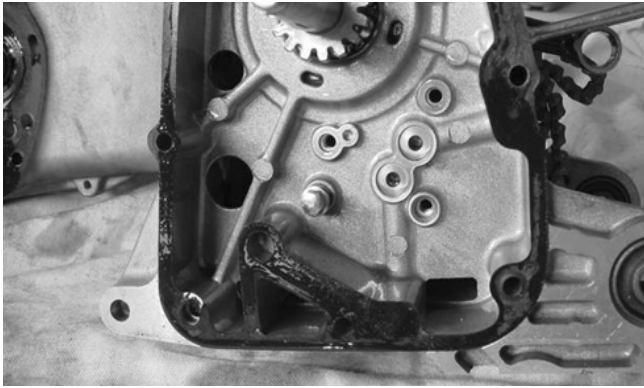

DSC02154

37. Using a plastic mallet, separate the crankcase halves. Account for two dowel pins from between the left-side and right-side of the crankcase halves.

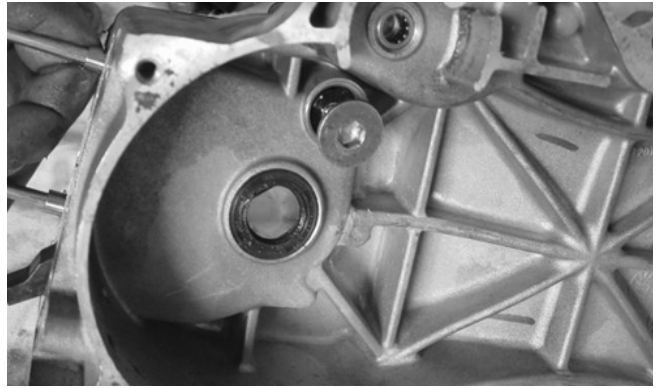

DSC02163

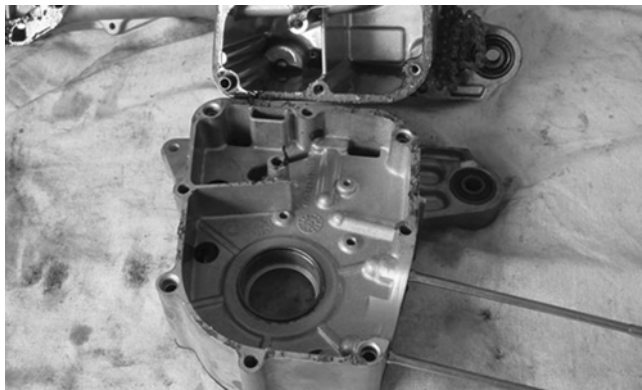

DSC02156

38. Remove the cam chain from the crankshaft sprocket; then remove the crankshaft from the left-side crankcase half.



DSC02166

40. Using a seal driver or socket from the inside, remove the left-side and right-side crankcase seal.

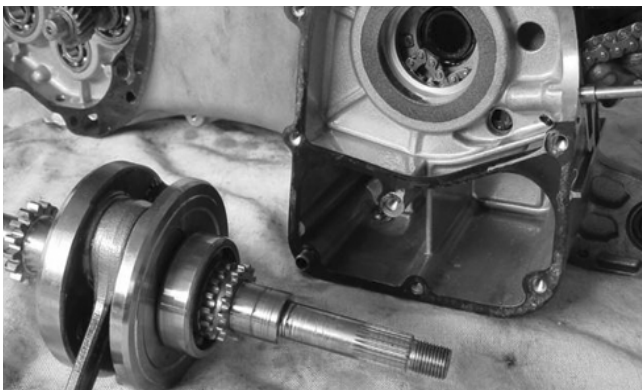

DSC02518

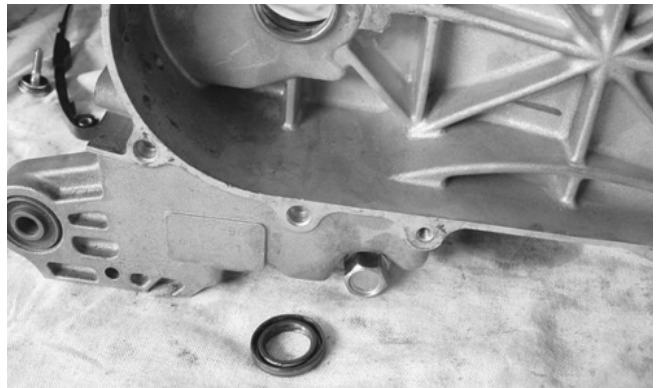

DSC02165

**⚠ CAUTION**

Remove the crankshaft carefully making sure the cam chain is free of the sprocket. If force is used, damage to the crankshaft sprocket, cam chain, or left-side crankcase half could occur.

39. Remove the Allen-head cap screw securing the cam chain tensioner; then remove the cam chain tensioner. Inspect the O-ring on the cap screw for damage.

---

---

## Table of Contents (Servicing Components)

---

Piston Assembly.....	3-16
Cylinder/Cylinder Head .....	3-17
Centrifugal Clutch/Driven Pulley .....	3-20
Oil Pump .....	3-21

---

---

## Piston Assembly

---

■ **NOTE:** Whenever a piston, rings, or pin is out of tolerance, it must be replaced.

### CLEANING/INSPECTING PISTON

1. Using a non-metallic carbon removal tool, remove any carbon buildup from the dome of the piston.
2. Inspect the piston for cracks in the piston pin, dome, and skirt areas.
3. Inspect the piston for seizure marks or scuffing. Repair with #400 grit wet-or-dry sandpaper and water or honing oil.

■ **NOTE:** If scuffing or seizure marks are too deep to repair with the sand paper, replace the piston.

4. Inspect the perimeter of each piston for signs of excessive “blowby.” Excessive “blowby” indicates worn piston rings or an out-of-round cylinder.

### REMOVING PISTON RINGS

1. Starting with the top ring, slide one end of the ring out of the ring groove.



DSC02175

2. Remove each ring by working it in a circular motion toward the dome of the piston.

■ **NOTE:** If the existing rings will not be replaced with new ones, note the location of each ring for proper installation. When installing new rings, install as a complete set only.

### CLEANING/INSPECTING PISTON RINGS

1. Take an old piston ring and snap it into two pieces; then grind the end of the old ring to a 45° angle and to a sharp edge.
2. Using the sharpened ring as a tool, clean carbon from the ring grooves. Be sure to position the ring with its tapered side up. Only use parts-cleaning solvent to clean the third ring groove (oil ring groove) of the piston.

#### CAUTION

Improper cleaning of the ring grooves by use of the wrong type of ring-groove cleaner will result in severe damage to the piston.

### MEASURING PISTON RING END GAP

1. Place each piston ring in the wear portion of the cylinder. Use the piston to position each ring squarely in the cylinder.
2. Using a feeler gauge, measure each piston ring end gap. Acceptable ring end gap must be within specifications.

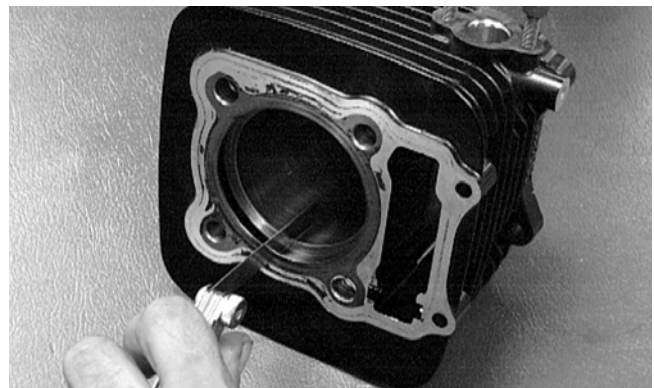

CC386D

### MEASURING PISTON PIN (Outside Diameter) AND PISTON PIN BORE

1. Measure the piston pin outside diameter at each end and in the center. Minimum diameter must be within specifications. If measurement is not within specifications, the piston pin must be replaced.

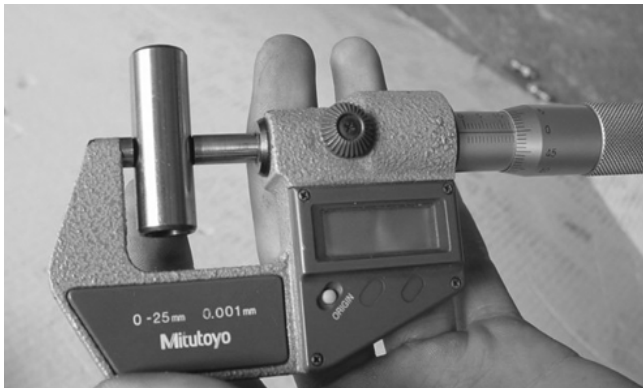

DSC02176

2. Insert an inside dial indicator into the piston pin bore. The maximum diameter must be within specifications. Take two measurements to ensure accuracy.

### MEASURING PISTON SKIRT/CYLINDER CLEARANCE

1. Insert an inside dial indicator to measure the cylinder front to back in six places.
2. Measure the corresponding piston diameter at a point 10 mm (0.40 in.) above the piston skirt at a right angle to the piston-pin bore. Subtract this measurement from the measurement in step 1. The difference (clearance) must be within specifications.



DSC02178

### INSTALLING PISTON RINGS

1. Install the oil expander ring in the bottom ring groove of the piston; then install the lower and upper scraper rings over the expander making sure the ends of the expander do not overlap. Stagger the end gaps of the scraper rings according to the illustration.

#### ⚠ CAUTION

Incorrect installation of the piston rings will result in engine damage.

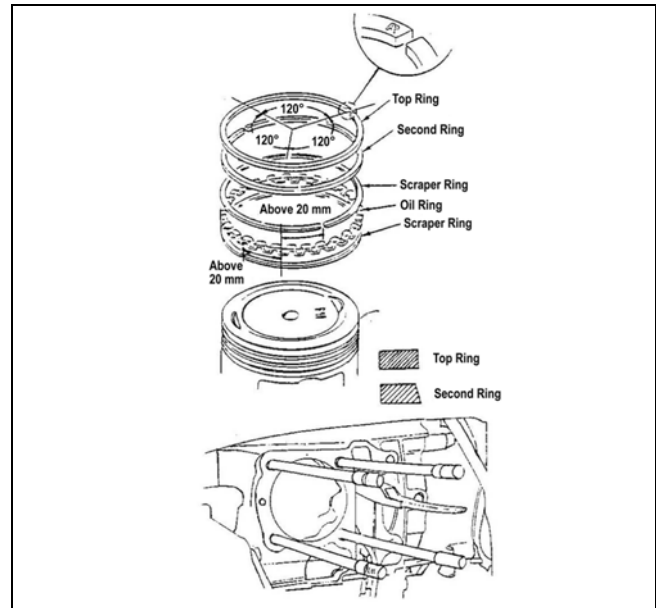

DSC00100

2. Install the second compression ring with the taper directed toward the piston dome; then install the top compression ring with the orientation mark directed toward the piston dome. Stagger the ring end gaps according to the illustration.

**3**

## Cylinder/Cylinder Head

### CLEANING/INSPECTING CYLINDER HEAD

1. Using a non-metallic carbon removal tool, remove any carbon buildup from the combustion chamber being careful not to nick, scrape, or damage the combustion chamber or the gasket sealing surface.
2. Inspect the spark plug hole for any damaged threads. Repair damaged threads using a "heli-coil" insert.
3. Place the cylinder head on Surface Plate (p/n 0644-016) covered with #400 grit wet-or-dry sandpaper. Using light pressure, move the cylinder head in a figure eight motion. Inspect the sealing surface for any indication of high spots. A high spot can be noted by a bright metallic finish. Correct any high spots before assembly by continuing to move the cylinder head in a figure eight motion until a uniform bright metallic finish is attained.

#### ⚠ CAUTION

Water or parts-cleaning solvent must be used in conjunction with the wet or dry sandpaper or damage to the sealing surface may result.

## REMOVING VALVES

■ **NOTE:** Keep all valves and valve components as a set. Note the original location of each valve set for use during installation. Return each valve set to its original location during installation.

1. Using a valve spring compressor, compress the valve springs and remove the valve cotters. Account for an upper spring retainer.

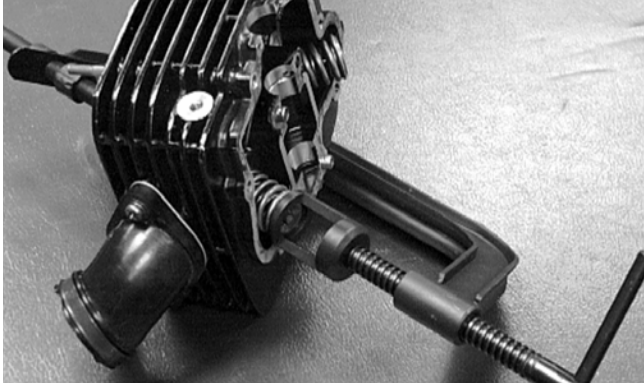

CC391D

2. Remove the valve seal and the lower remaining spring seat. Discard the valve seal.

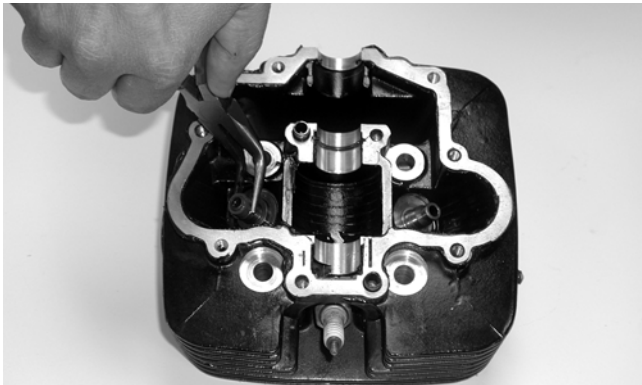

CC928

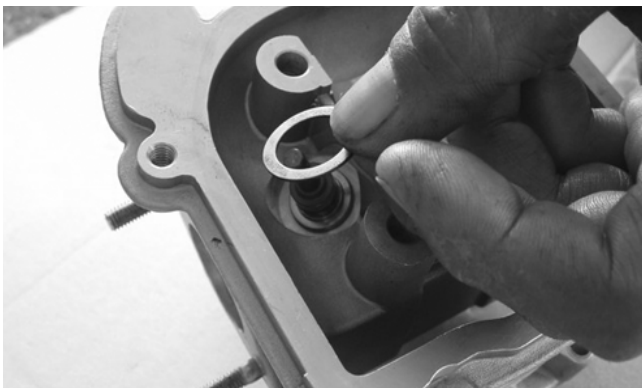

DSC2274

■ **NOTE:** The valve seals must be replaced.

3. Remove the valve springs; then invert the cylinder head and remove the valves.

## Measuring Valve stem to valve guide clearance

1. Insert a snap gauge 1/2 way down into each valve guide bore; then remove the gauge and measure it with a micrometer. Record the measurement.
2. Using a micrometer, measure the outside diameter of the valve stem near the middle. Subtract this measurement from the valve guide bore to obtain the clearance measurement. Clearance must not exceed specifications.

## MEASURING CYLINDER HEAD DISTORTION

1. Lay a straightedge across the cylinder head; then using a thickness gauge, check the distortion between the head and the straightedge.

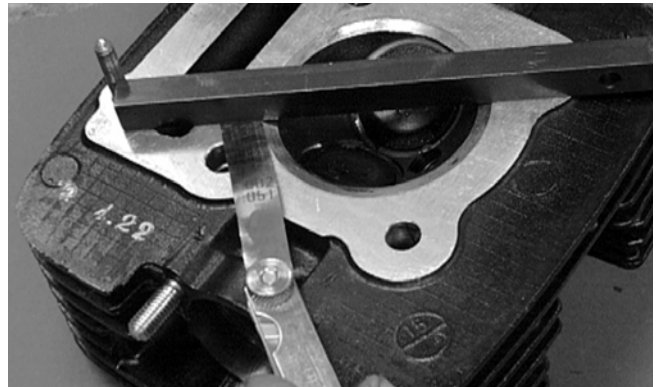

CC388D

2. Maximum distortion must be within specifications.

## CLEANING/INSPECTING CYLINDER

1. Wash the cylinder in parts-cleaning solvent.
2. Inspect the inside of the cylinder for pitting, scoring, scuffing, glazing, or corrosion. If marks are found, repair the surface using a ball hone (see Honing Cylinder in this sub-section).
3. Place the head surface of the cylinder on the surface plate covered with #400 grit wet-or-dry sandpaper. Using light pressure, move the cylinder in a figure eight motion. Inspect the sealing surface for any indication of high spots. A high spot can be noted by a bright metallic finish. Correct any high spots before assembly by continuing to move the cylinder in a figure eight motion until a uniform bright metallic finish is attained.

## CLEANING/INSPECTING VALVES

1. Using parts-cleaning solvent and a wire brush, clean the valves.

- Using a calipers, measure the valve stem diameter that it is within specifications.

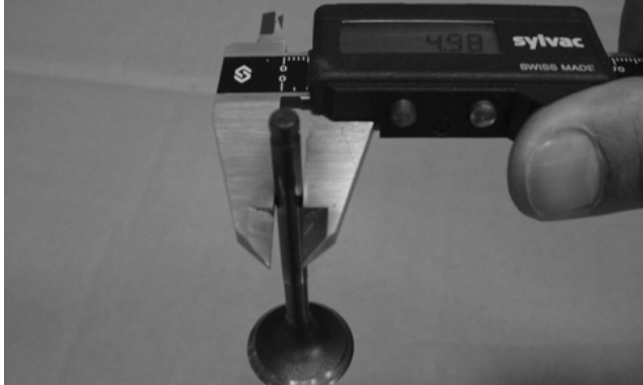

DSC02201

■ **NOTE:** If the valve stem diameter is not within specifications, the valve must be replaced.

### MEASURING ROCKER ARM TO SHAFT CLEARANCE

- Using a calipers, measure the inside diameter of the rocker arm. Record this measurement.
- Using a micrometer, measure the outside diameter of the rocker arm shaft. Subtract this measurement from the rocker arm inside diameter. The rocker arm to shaft clearance must not exceed specifications.

### HONING CYLINDER

- Using a slide gauge and dial indicator, measure the cylinder bore at three locations from top to bottom; then repeat the measurements 90° from the first measurements for a total of six measurements. The variation (out-of-roundness) is the difference between the highest and lowest reading. Maximum variation (out-of-roundness) must not exceed specifications.

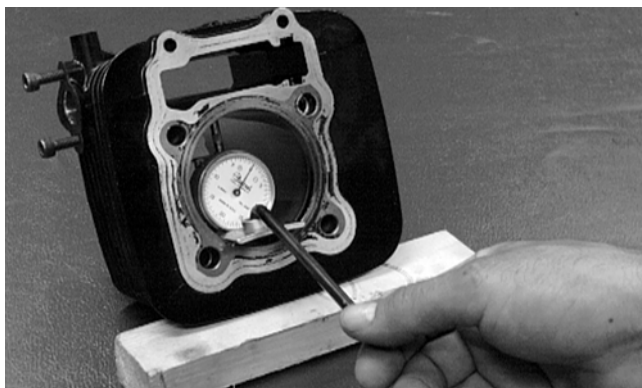

CC397D

- Wash the cylinder in parts-cleaning solvent; then inspect the cylinder wall for pitting, scoring, scuffing, glazing, or corrosion. If marks are found, repair the surface using a ball hone.

■ **NOTE:** To produce the proper 60° cross-hatch pattern, use a low RPM drill (600 RPM) at the rate of 30 strokes per minute. If honing oil is not available, use a lightweight petroleum-based oil. Thoroughly clean the cylinder after honing using mild soap and hot water. Dry with compressed air; then immediately apply oil to the cylinder bore. If the bore is severely damaged or scored, replace the cylinder.

- If any measurement exceeds the specified limit, the cylinder must be replaced.

### MEASURING VALVE SPRINGS

Using a calipers, measure the free length of the valve springs. If any spring is not within specifications, it must be replaced.

### MEASURING CAMSHAFT LOBE HEIGHT

- Using a calipers, measure each cam lobe height.

**3**

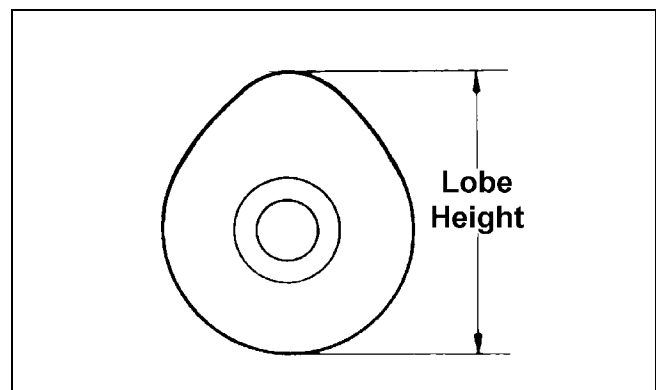

ATV1013A

- The lobe heights must be equal and must not exceed minimum specifications.

### INSTALLING VALVES

- Apply grease to the inside surface of the valve seals; then place a lower spring seat and valve guide seal over each valve guide.
- Insert each valve into its original valve location.
- Install the valve springs with the painted end of the spring facing away from the cylinder head.

■ **NOTE:** If the painted end is not visible, install the ends of the springs with the closest coils toward the head.



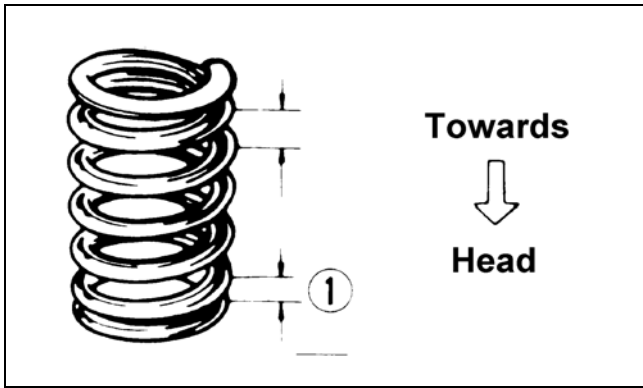

ATV-1011A

4. Place a spring retainer over the valve springs; then using the valve spring compressor, compress the valve springs and install the valve coters.

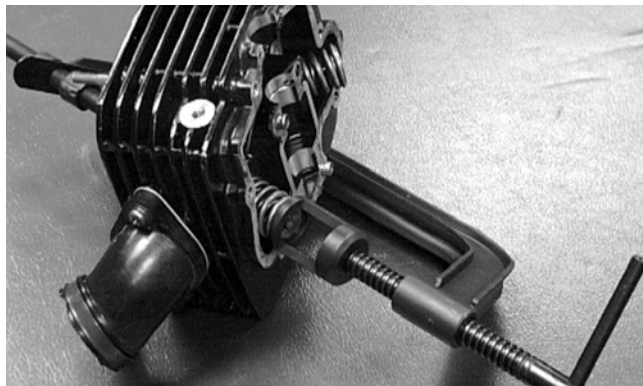

CC391D

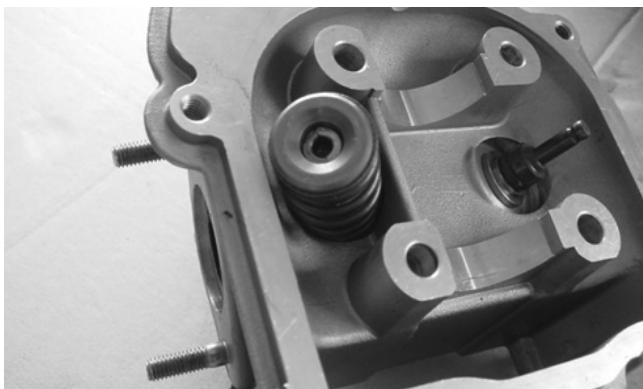

DSC02276

## Centrifugal Clutch/ Driven Pulley

### MEASURING COMPONENTS

1. Using a calipers, measure the front roller guide diameter. Measurement must be equal to or greater than minimum specifications.

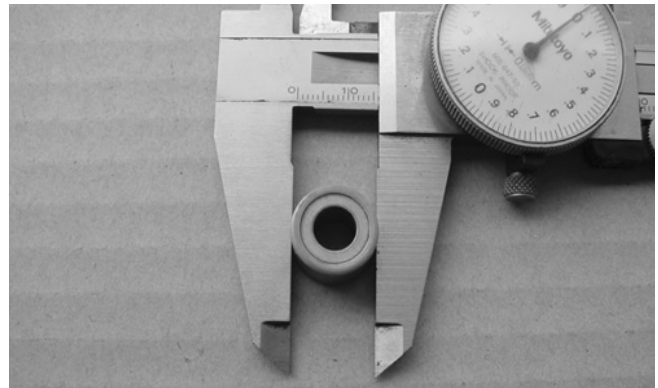

DSC02209

2. Using a calipers, measure the outside diameter of the collar in the movable drive face. Measurement must be equal to or greater than minimum specifications.

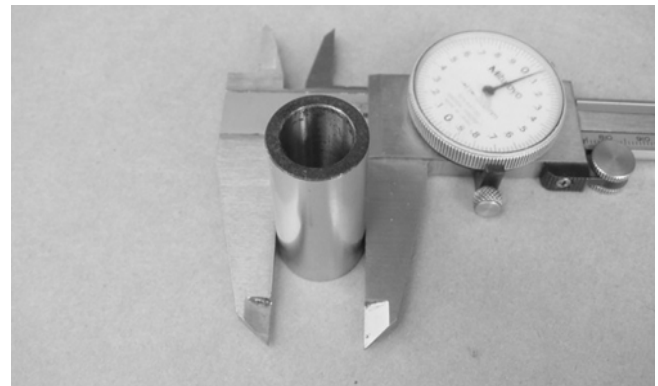

DSC02211

3. Using a calipers, measure the drive belt width. Measurement must be equal to or greater than minimum specifications.

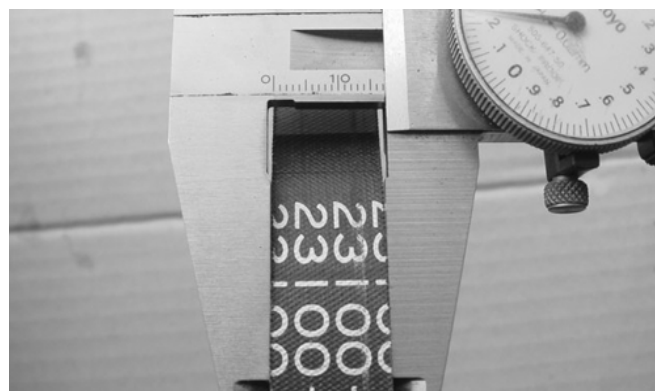

DSC02210

4. Using a calipers, measure the inside diameter of the centrifugal clutch housing. Measurement must be equal to or no less than maximum specifications.

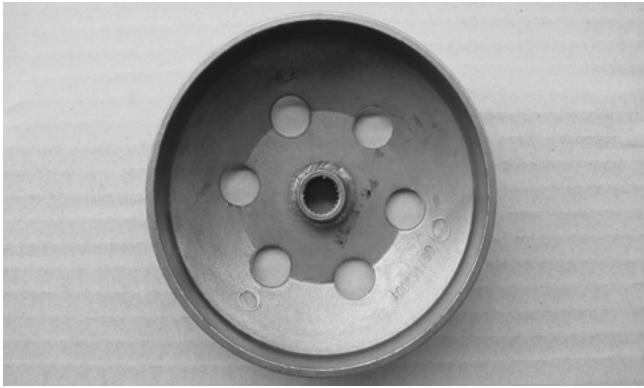

DSC02202

5. Using a calipers, measure the centrifugal clutch lining thickness. Measurement must be equal to or greater than minimum specifications.

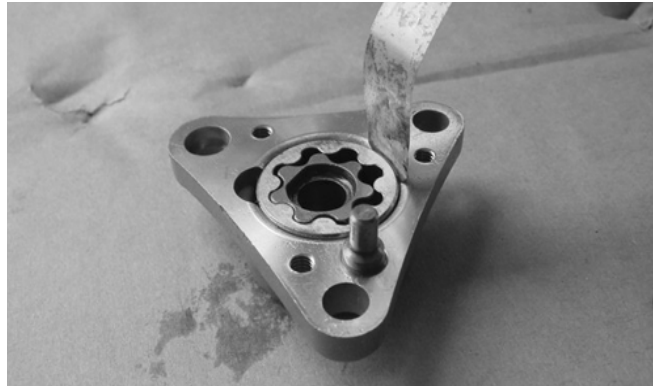

DSC02220

3. Using a thickness gauge, measure the space between the outer rotor and inner rotor. Measurement must be equal to or less than maximum specifications.

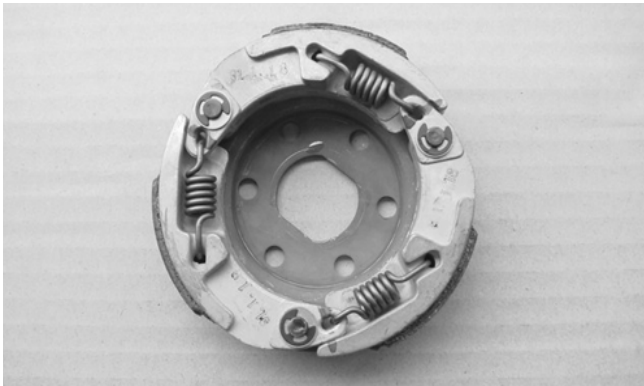

DSC02203

6. Using a calipers, measure the driven pulley spring free length. Measurement must be equal to or greater than minimum specifications.

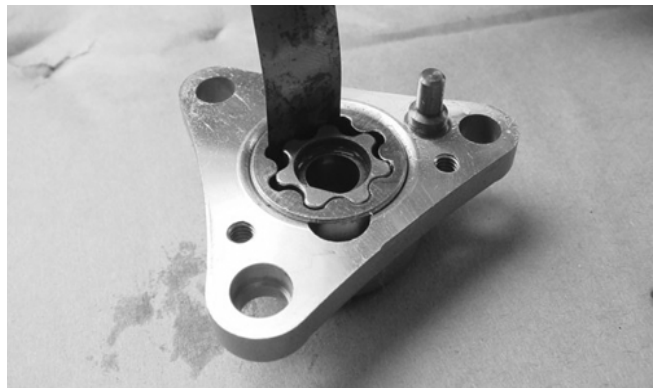

DSC02221

4. Using a thickness gauge and a straightedge, measure the distortion of the pump housing. Measurement must be equal to or less than maximum specifications.

3

---

## Oil Pump

---

### MEASURING COMPONENTS

1. Remove the three Phillips-head screws from the oil pump housing.
2. Using a thickness gauge, measure the clearance between the outer rotor and housing. Measurement must be equal to or less than maximum specifications.

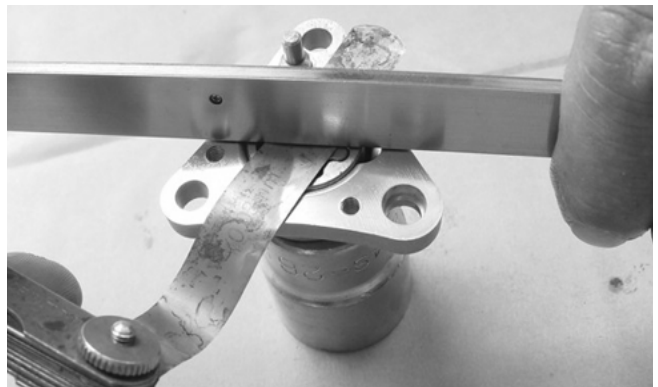

DSC02222

## Assembling Engine/Transmission

1. Install the left-side crankcase seal with a seal driver or socket. Carefully drive the seal to the edge of the crankcase. Apply grease around the oil seal lip.
2. Clean the contact surface of the crankcase between the right-side half and left-side half. Place the cam chain into the left-side crankcase. Apply engine oil to the slot in the big end of the connecting rod and to both crankshaft bearings; then install the crankshaft into the left-side half.



DSC02212

### CAUTION

Care must be taken when installing the crankshaft into the left-side crankcase half to avoid jamming the cam chain and damaging the sprocket, chain, or crankcase.

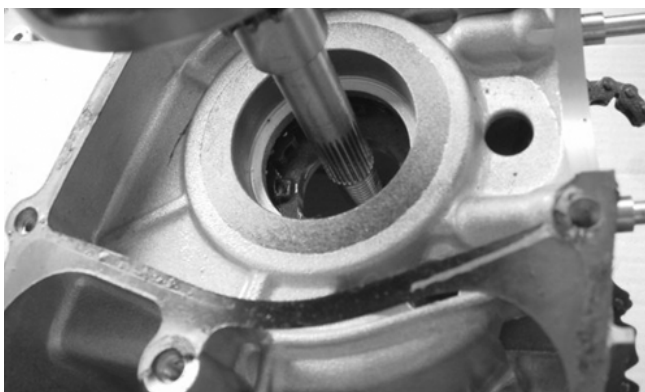

DSC02213

3. Rotate the crankshaft and the connecting rod assembly to locate the connecting rod in the center of the cylinder opening.



DSC02214

4. Install a new gasket and two dowel pins on the left-side crankcase half.

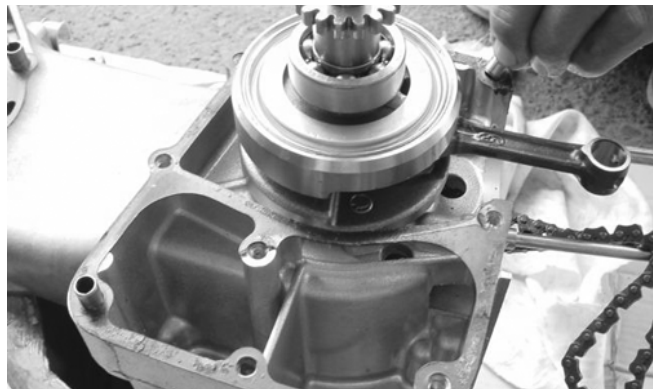

DSC02215

5. Install the right-side crankcase half into the left-side crankcase half aligning the two dowel pins. Lightly coat the cap screw with red Loctite #271; then tighten to specifications.

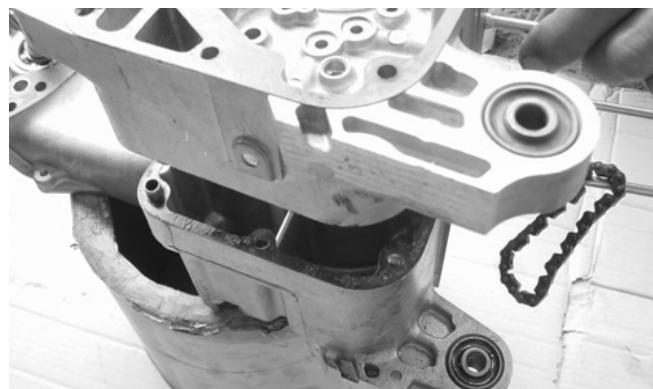

DSC02216

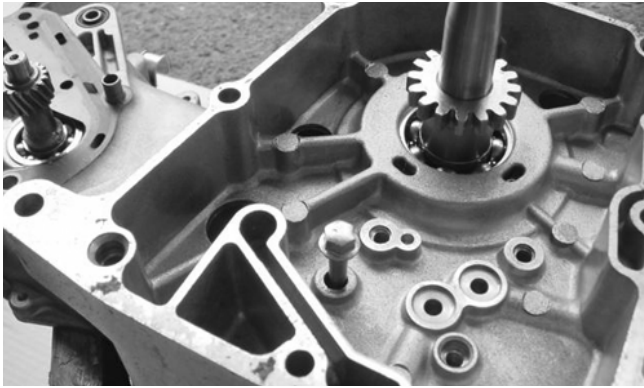

DSC02217

6. Install two O-rings, one alignment pin, and the oil pump on the right-side crankcase half; then secure with three cap screws tightened to specifications.

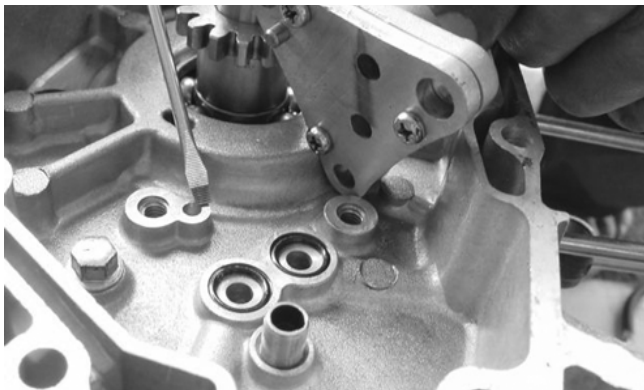

DSC02224

**⚠ CAUTION**  
Take care that the locating pin (small pin) and the alignment pin (larger bushing) engage the oil pump and crankcase properly or damage to the engine will occur.



DSC02226

7. Install the oil pump sprocket with the nut. Tighten the nut to specifications.

**⚠ CAUTION**  
Take care that the flat in the oil pump sprocket hub is aligned with the flat on the oil pump shaft or damage to the sprocket and shaft will occur.

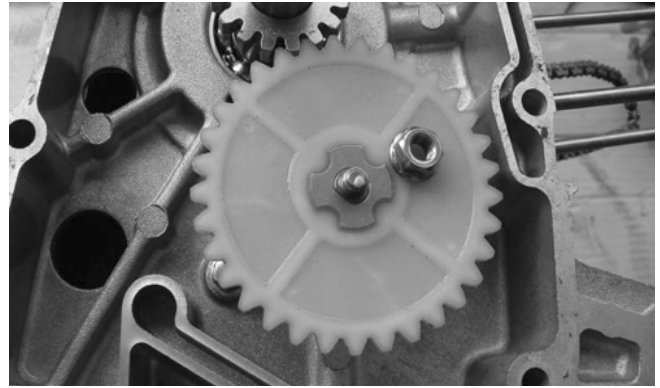

DSC02227

8. Install the right-side crankcase cover seal with a seal driver or socket. Apply a light coat of grease around the oil seal lip.

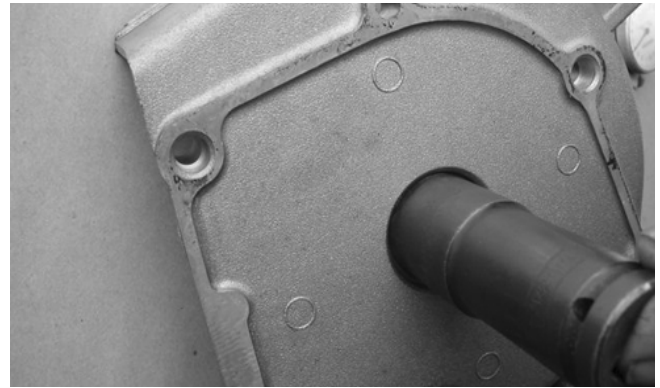

DSC02230

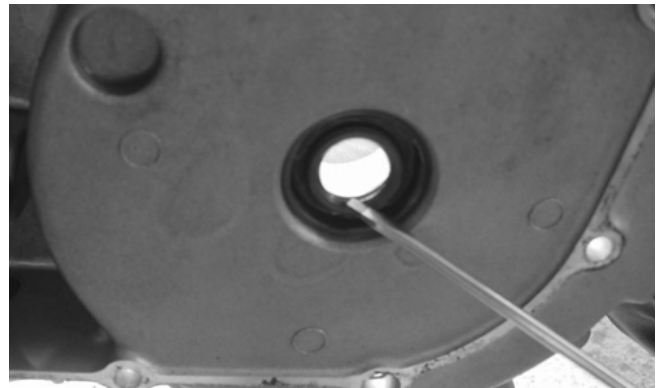

DSC02232

9. Install a new gasket and two dowel pins on the right-side crankcase half.

■ **NOTE:** The two contact surfaces must be clean before installing the gasket.

10. Install the eight cap screws to the right-side crankcase cover. Apply red Loctite #271 on the cap screws and tighten to specifications.

■ **NOTE:** Note the correct position for the different-lengthed cap screws that they are installed in the proper locations.

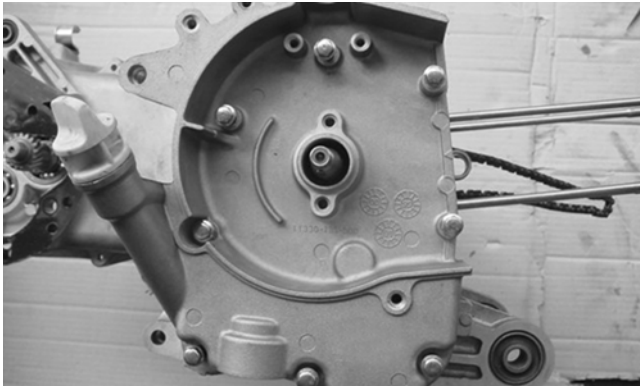

DSC02234

11. Install the stator in the right-side crankcase cover; then install the two cap screws (coated with red Loctite #271). Tighten to specifications.

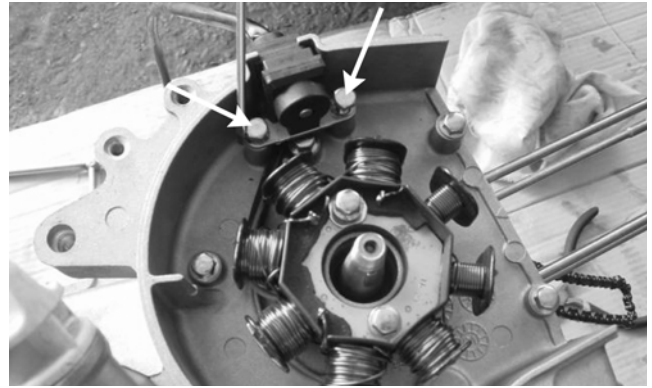

DSC02240B

13. Press the flywheel key into the crankshaft keyway and install the flywheel on the crankshaft. Install the washer and flange nut; then tighten to specifications.

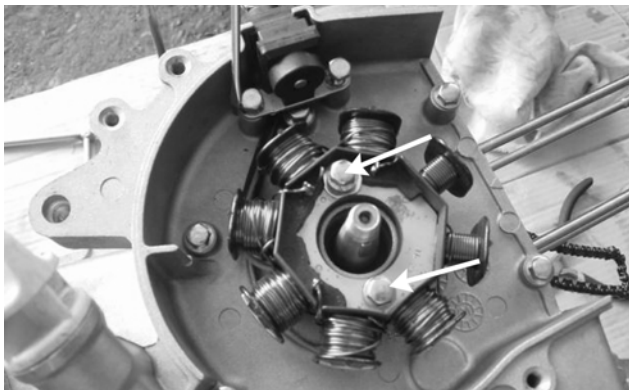

DSC02240A

12. Install the formed grommet into the cover slot; then place the source coil into position on the mounting towers. Secure with two cap screws tightened to specifications.



DSC02241

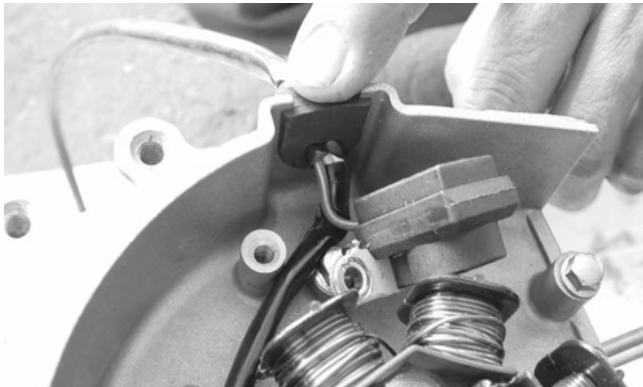

DSC02237



DSC02243



DSC02246

14. Install the cooling fan with four cap screws; then tighten to specifications.

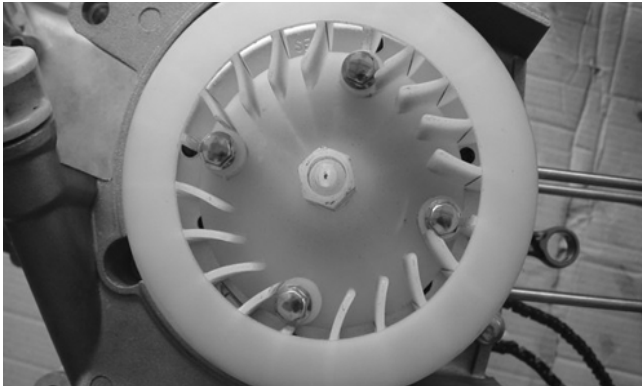

DSC02247

15. Install the oil screen/filter, spring, and cap with O-ring. Tighten the cap to specifications.

■ **NOTE:** The closed end of the spring must be directed into the cap.

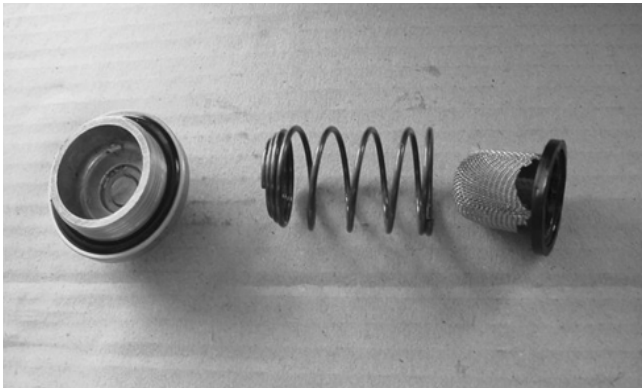

DSC02248

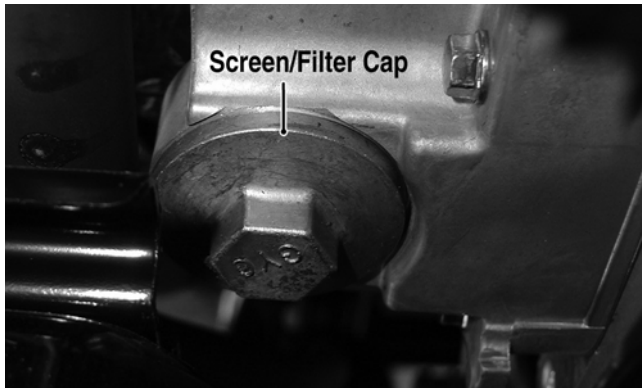

KM040A

16. Install the cam chain tensioner and secure with the Allen-head cap screw and O-ring. Apply a light coat of grease on the O-ring and tighten to specifications.

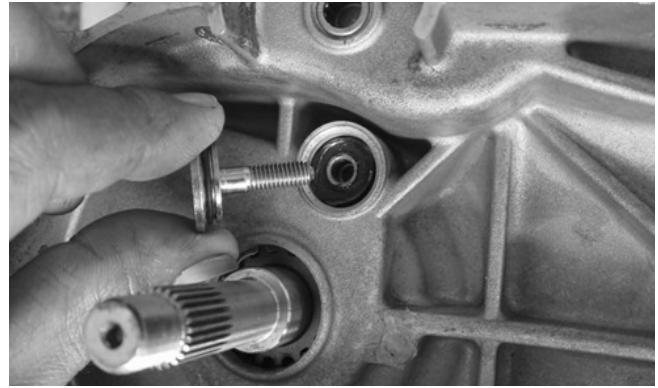

DSC02250

17. Install the two dowel pins on the left-side crankcase; then install the cylinder gasket.

**CAUTION**

The surface beneath the cylinder gasket must be thoroughly cleaned prior to installing.

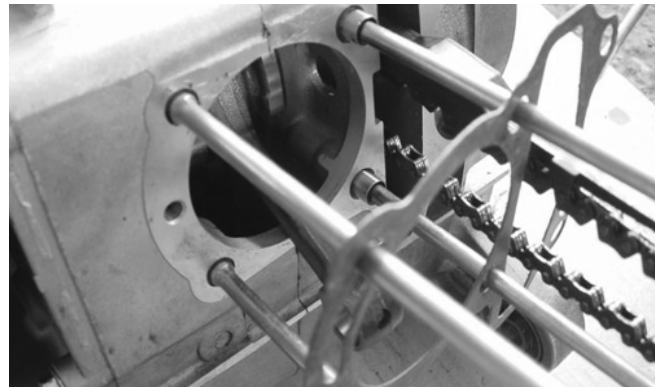

DSC02251

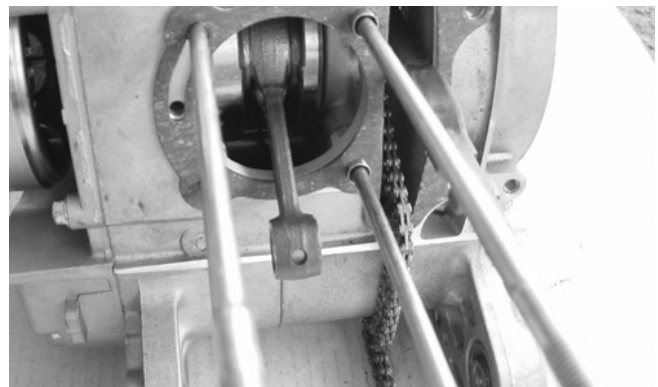

DSC02252

18. Install the oil expander ring in the bottom ring groove of the piston; then install the lower and upper scraper rings over the expander making sure the ends of the expander do not overlap. Stagger the scraper end gaps of the upper and lower rings according to the illustration.

19. Install the second compression ring with the taper directed toward the piston dome; then install the top compression ring with the orientation mark directed toward the piston dome. Stagger the ring ends gaps according to the illustration.

**3**

**CAUTION**

Incorrectly installing the piston rings will result in engine damage.

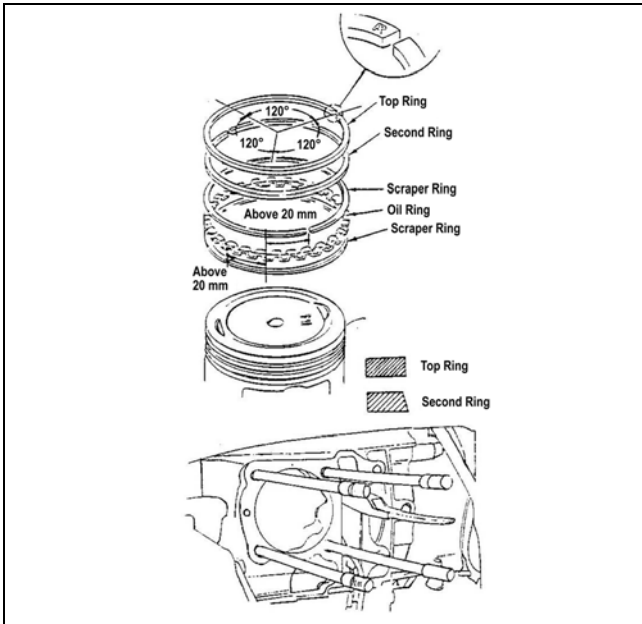

DSC00100

20. Install one of the piston pin circlips into one side of the piston with the opening directed toward the skirt or the dome.

■ **NOTE:** When installing the circlips, compress them just enough to install. Do not over-compress the circlips.

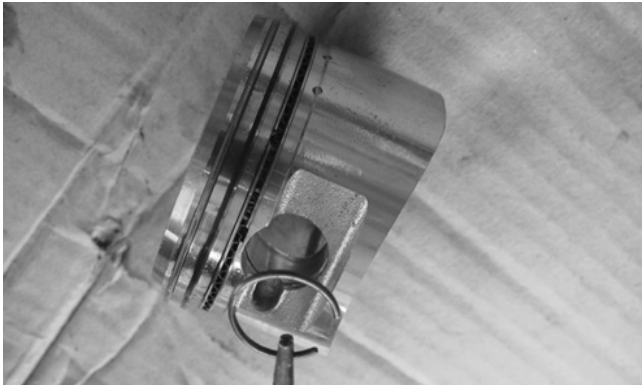

DSC02253

21. Install the piston on the connecting rod with the IN mark on the piston dome directed toward the intake port; then seat the piston pin against the installed circlip and install the second circlip with the opening directed toward the skirt or piston dome.



DSC02259

■ **NOTE:** Make sure the rings rotate freely and the ring gaps are separated by 120° as illustrated.

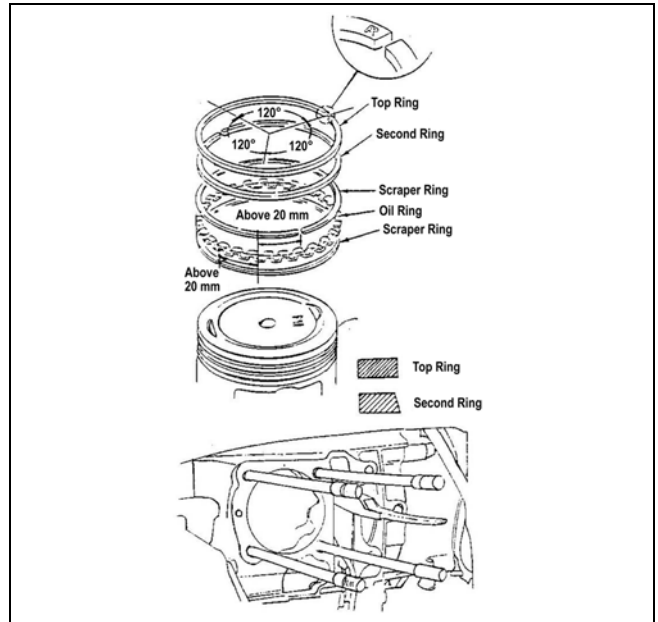

DSC00100

22. Apply engine oil to the piston and the cylinder wall.

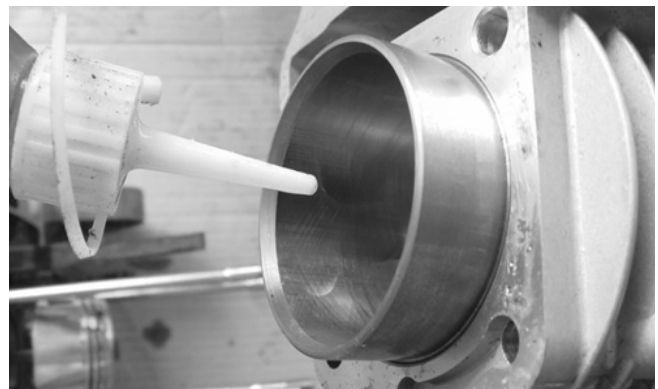

DSC02260

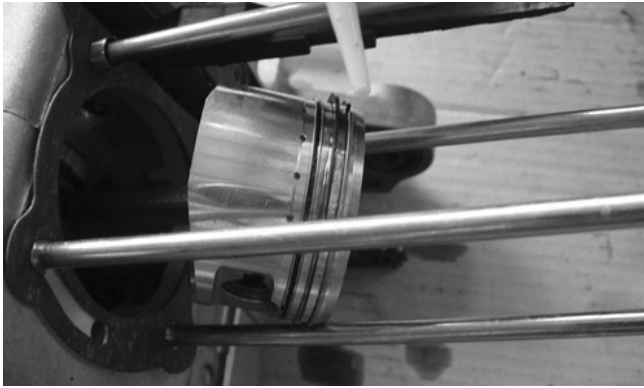

DSC02261

23. Extend the cam chain through the cylinder; then install the cylinder onto the piston and crankcase assembly. Make certain the dowel pins seat into the cylinder base.

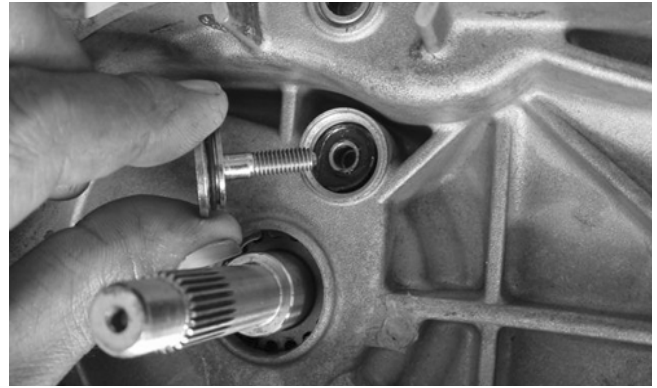

DSC02250

25. Install the two alignment pins and the cylinder head gasket onto cylinder. Pull the chain out through the gasket and cylinder head making sure the alignment pins seat properly into the cylinder head.

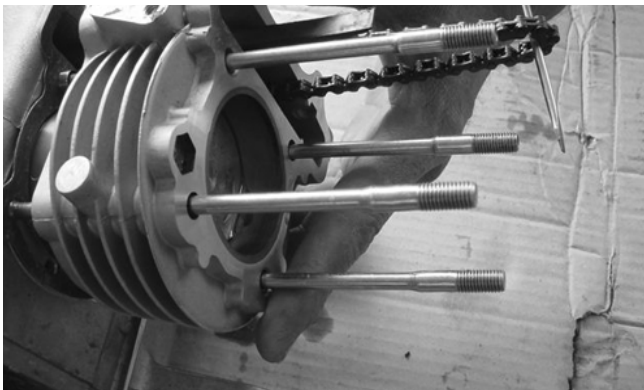

DSC02262

24. Locate the bottom chain guide into the groove on the cylinder; then install the Allen-head cap screw and O-ring.

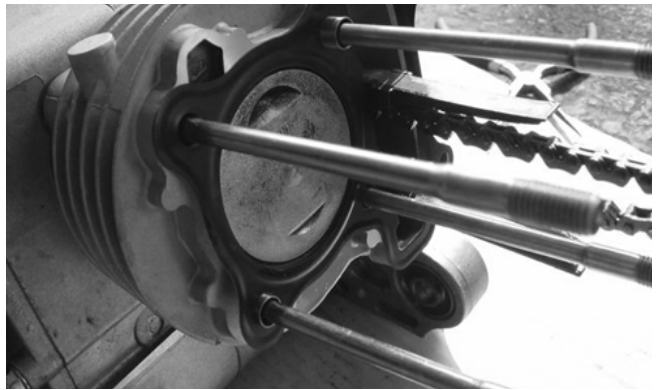

DSC02281

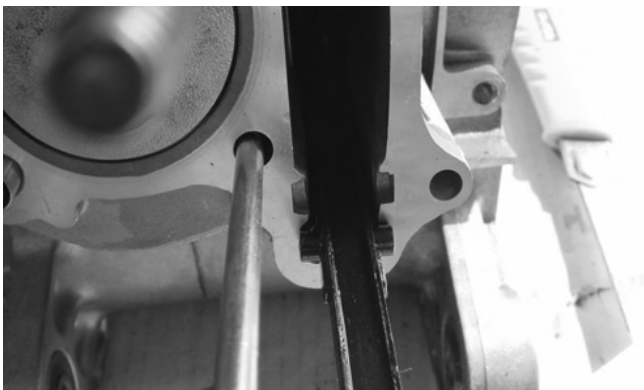

DSC02280

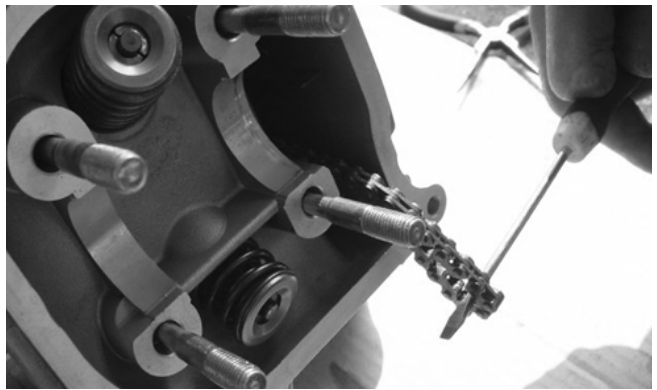

DSC02282

26. Keeping tension on the cam chain, rotate the flywheel and align the "T" mark to the right-side crankcase cover timing pointer setting the crankshaft to the TDC position.



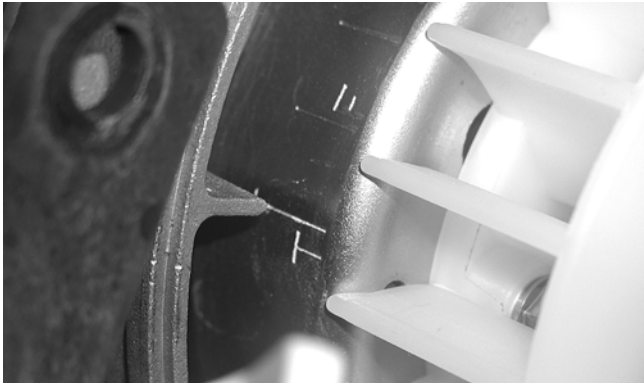

CD652

27. Install the chain over the camshaft sprocket. The larger hole should be directed away from the head and the timing marks should be parallel to the cylinder head top surface.



DSC02267



DSC02283

28. Install the rocker arm assembly into the camshaft holder.

■ **NOTE:** To enable installation on the head studs, the recesses in the rocker arm shafts must be aligned with the holes in the shaft supports.



DSC02266



DSC02268

29. Install the two alignment pins and the camshaft holder onto the cylinder head. Using a screwdriver turn the rocker arm shafts to locate the recess to the studs.

**⚠ CAUTION**

If the valve adjusters have pressure during rocker arm installing, the valve could be damaged. Always loosen the valve adjusters prior to installing.

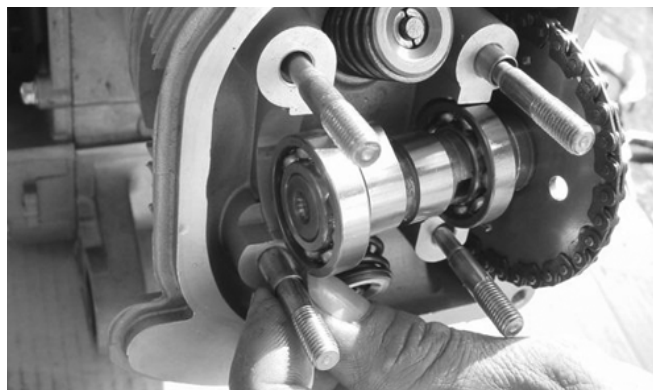

DSC02284

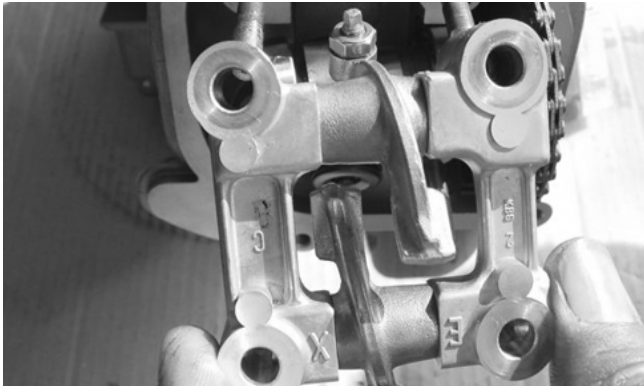

DSC02285

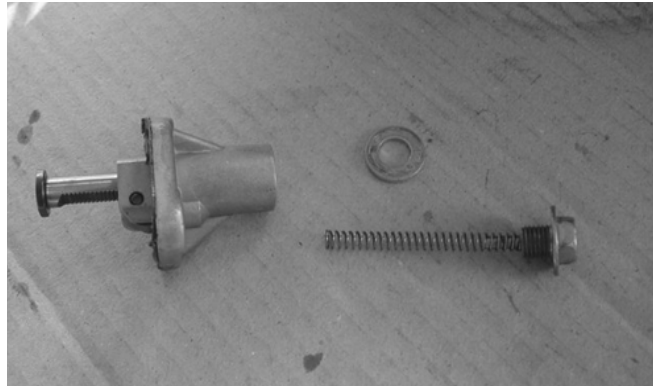

DSC02291

32. Depress the ratchet and retract the rod; then install the chain tensioner body to the cylinder. Tighten the two cap screws to specifications.

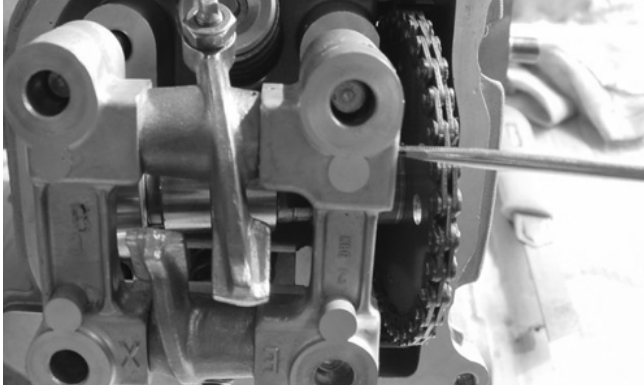

DSC02286

30. Install the four copper washers, four flange nuts, and two cap screws. Tighten the nuts to specifications; then tighten the cap screws to specifications.



DSC02293

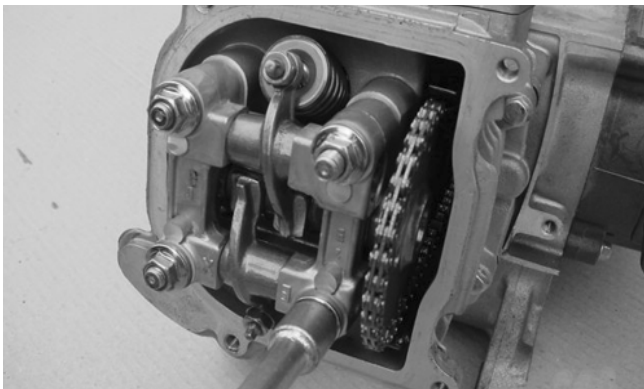

DSC02066

31. Remove the cap screw from the chain tensioner body. Account for the spring and the washer.



DSC02294

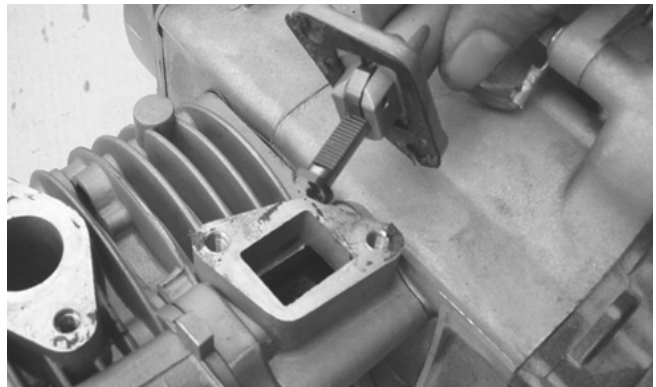

DSC02070

3

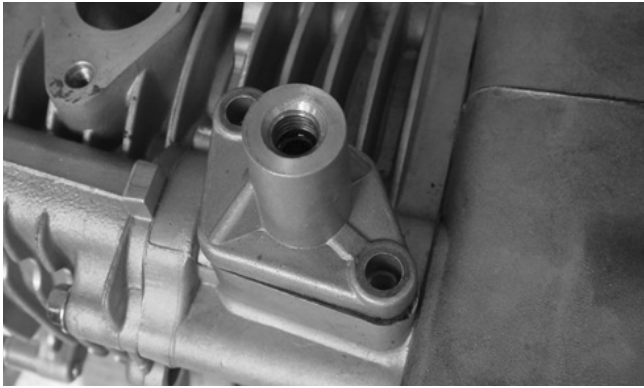

DSC02295

33. Install the spring, washer, and cap screw; then tighten to specifications.

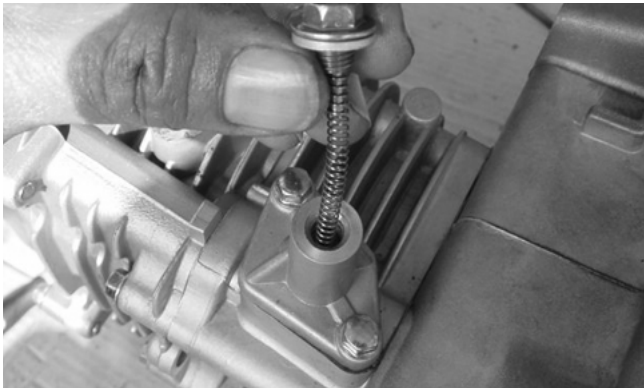

DSC02296

34. Rotate the flywheel to align the "T" mark to the timing line on the right-side crankcase cover.

■ **NOTE:** Rotate the flywheel clockwise several revolutions to purge oil from camshaft lobes, tappets, and drive chain.

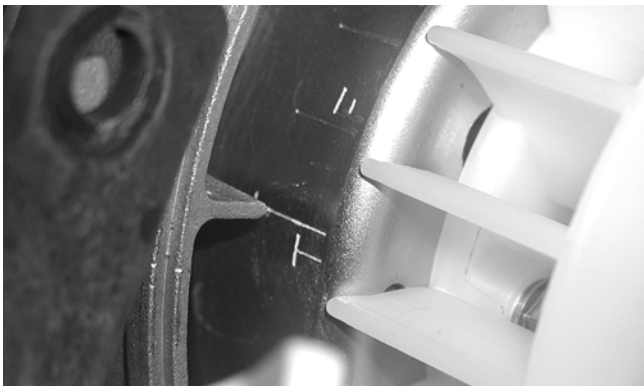

CD652

35. Using a thickness gauge, adjust the tappet clearance to specifications; then holding the adjuster stationary, tighten the valve adjuster jam nuts securely. Recheck the adjustment with the thickness gauge.

36. Install the spark plug and tighten to specifications.

37. Install the cylinder head cover and secure with four cap screws. Tighten to specifications.



DSC02289

38. Inspect the transmission bearings and oil seals. Replace any worn or broken seals with new ones. Replace any rough or worn bearings; then install the gasket and two alignment pins and press the drive gear into the bearing.

39. Install the final drive gear, intermediate gear, and the final driven gear shaft into the left-side crankcase.

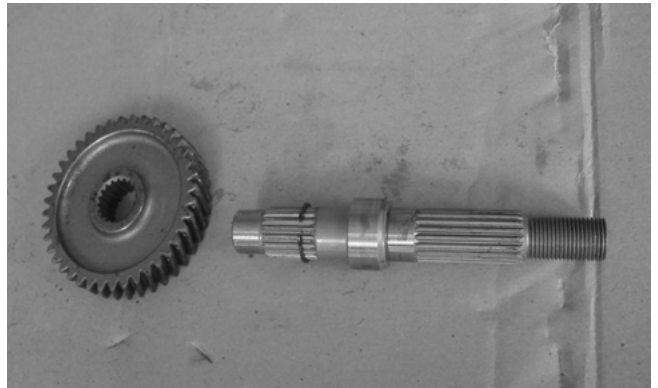

DSC02303



DSC02300

40. Install the transmission cover onto the left-side crankcase; then secure with the seven cap screws. Lightly apply red Loctite #271 to the threads and tighten to specifications.

■ **NOTE:** The two longer cap screws should be located at the alignment pin positions.

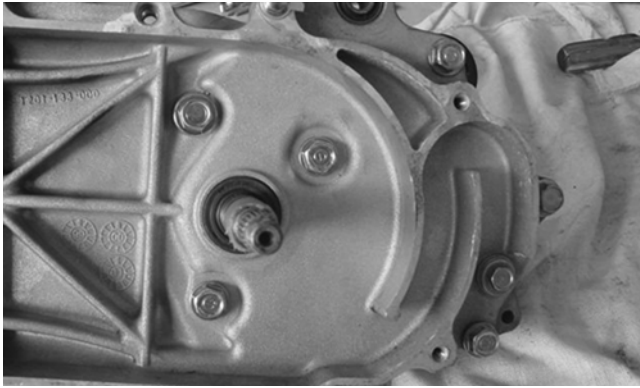

DSC02140

41. Fill the transmission with approximately 100 ml (3.4 fl oz) of the recommended transmission lubricant or until lubricant is visible at the fill/level hole.



DSC0232

43. Install the centrifugal clutch assembly to the driven pulley by compressing the spring and installing the 28 mm nut. Tighten to specifications.

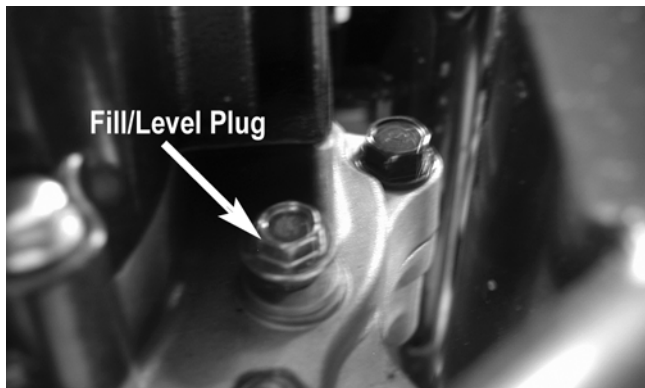

Fill/Level Plug

CD633A

42. Install the countershaft sprocket with the spacer to the inside and tighten the lock nut to specifications.



DSC02309



DSC02310

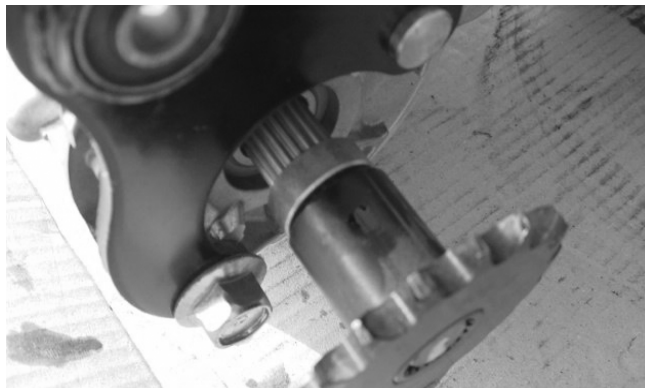

DSC02320



DSC02311

3

44. Spread the faces of the driven pulley by grasping the outer driven face tightly and pulling out away from the base (toward the clutch); then while holding the faces apart, insert the drive belt. Install the driven pulley and belt onto the driveshaft together.

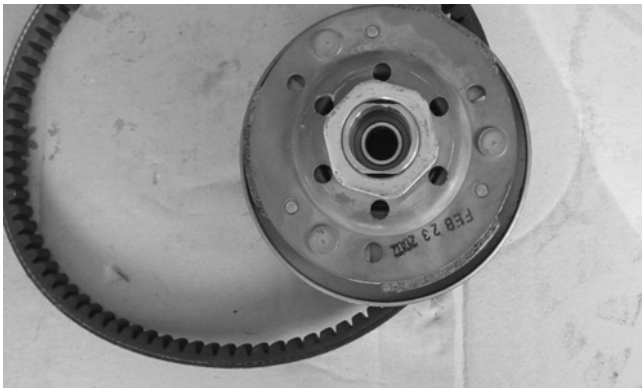

DSC02313

45. Install the centrifugal clutch housing over the centrifugal clutch/driven pulley assembly. Secure with the flange nut tightened to specifications.

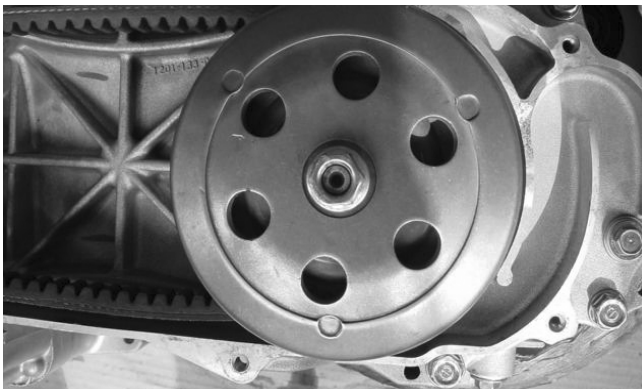

DSC02314

46. Install the starter motor into the left-side crankcase. Tighten the two cap screws to specifications.

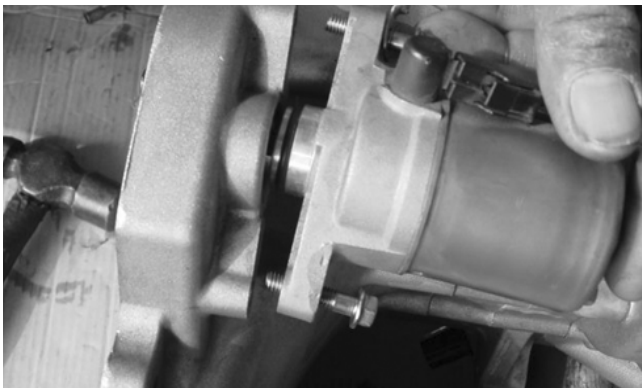

DSC02306

47. Install the starter one-way gear.

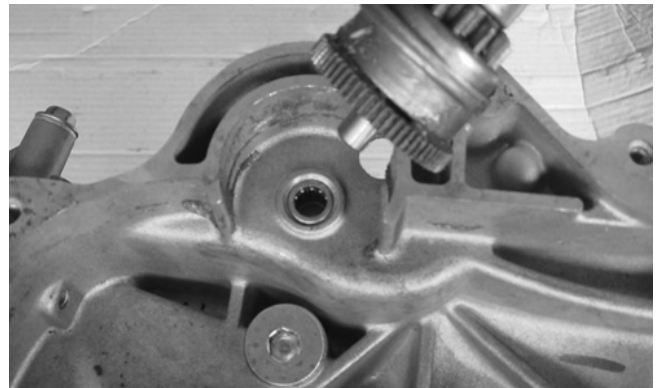

DSC02305

48. Install the drive face collar into movable drive face and the ramp plate taking care that the six roller guides are properly positioned.



DSC02307



DSC02308

49. Pinch the belt together near mid-span and slide the fixed drive face over the crankshaft. Install the drive face, cooling fan, ratchet, and washer; then apply red Loctite #271 to the flange nut. Tighten the nut to specifications.

■ **NOTE:** Make sure to clean the fixed drive face, movable drive face, and driven faces. Any grease or oil contamination will cause the drive belt to slip.

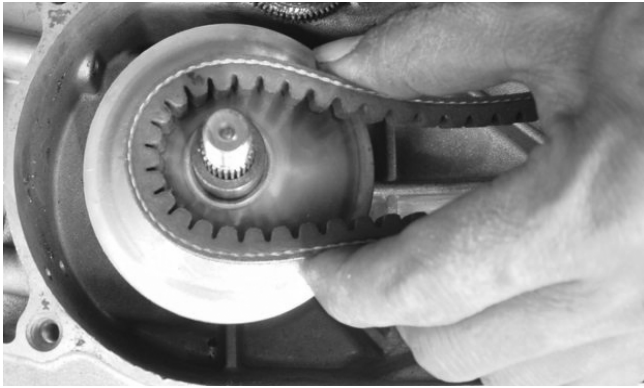

DSC02315

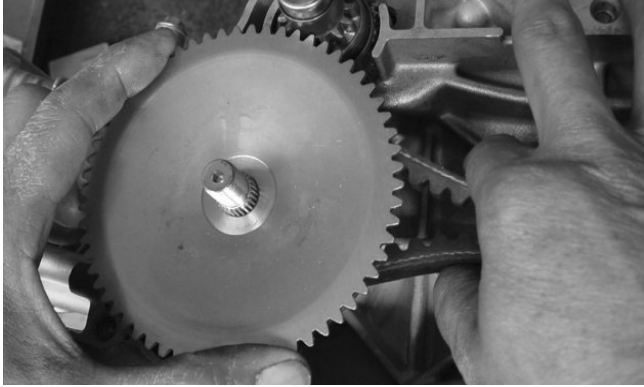

DSC02316



DSC02317

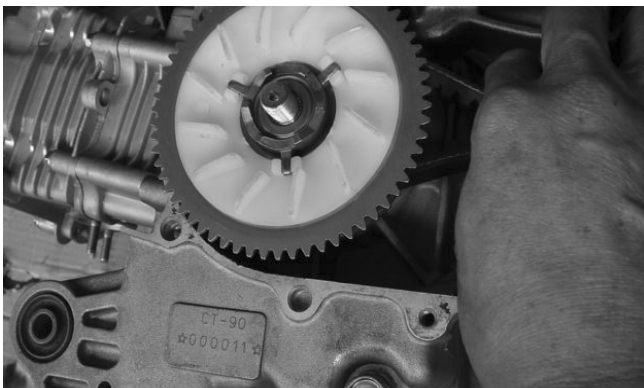

DSC02318

50. Rotate the drive belt and faces until the belt is flush with the top of the driven pulley.

51. Place two alignment pins, gasket, and the V-belt cover into position; then secure with the eight cap screws tightened to specifications.

52. Install the cylinder shroud seal.



DSC02322

53. Install the bottom cylinder shroud with one cap screw together with a hose bracket. Tighten to specifications.

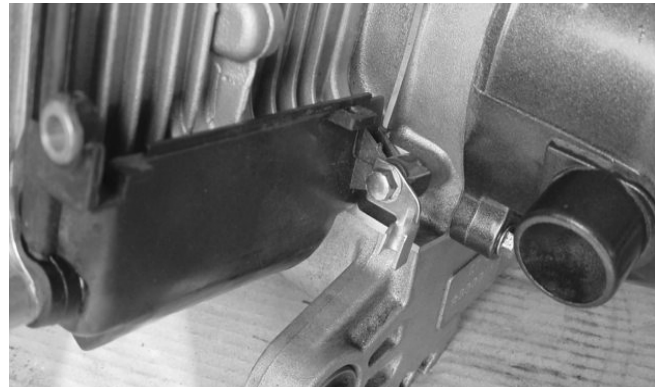

DSC02325

54. Install the top cylinder shroud, clamp, and the bottom shroud. Tighten two cap screws on each side. Install the cooling fan cover and secure with two cap screws on the crankcase and two self-tapping screws to the cylinder shroud.



DSC02326

55. Place the exhaust pipe and gasket into position on the cylinder and secure with the two cap screws. Tighten to specifications.

56. Fill the engine with the appropriate quantity and grade engine oil.

3

---

---

## Installing Engine/Transmission

---

---

1. Install the engine mounting bracket at the front of the engine and the two mounting cap screws at the rear. Tighten to specifications.



DSC02030

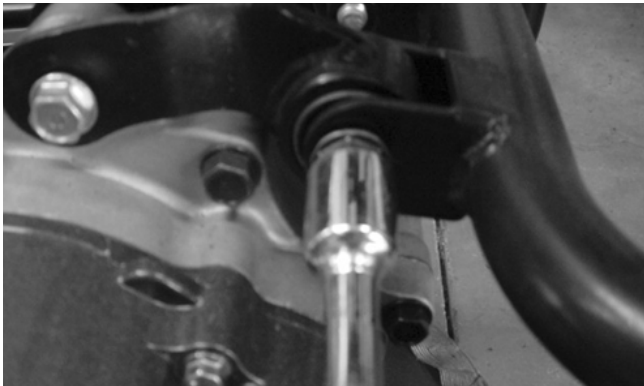

DSC02028

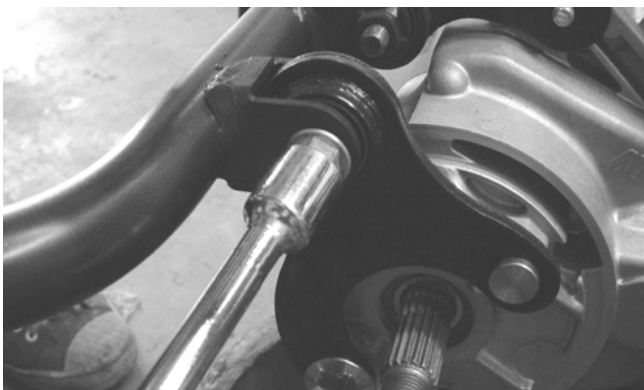

DSC02029

2. Install the spark plug cap onto the spark plug; then connect the starter motor wire and AC generator wire connectors on the left side of the frame.

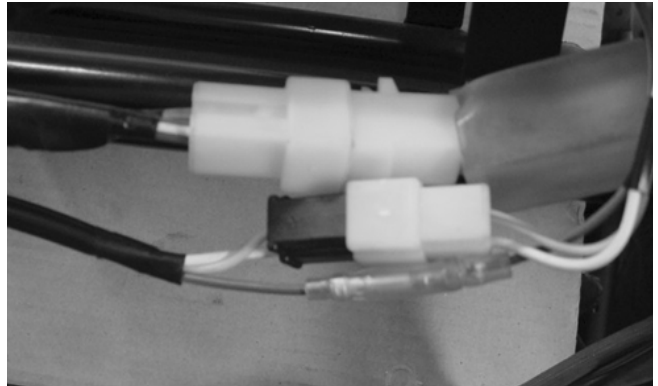

DSC02033

3. Install the drive chain; then connect with the master link and plate. Install the clip with the open end directed opposite of chain rotation.
4. Install the tailpipe at the hanging mount at the rear and at the flange. Tighten the rear bolt to specifications. Use a new gasket for the flange contact.

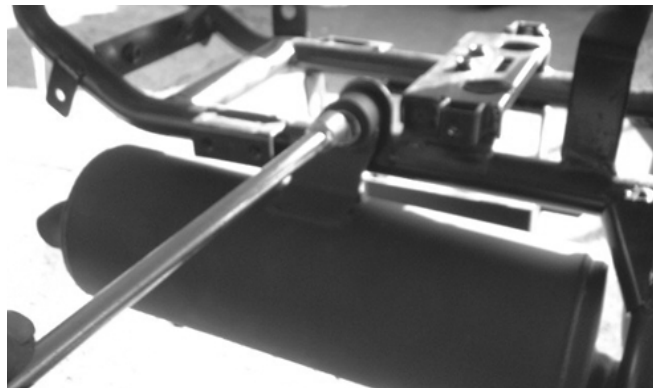

DSC02024

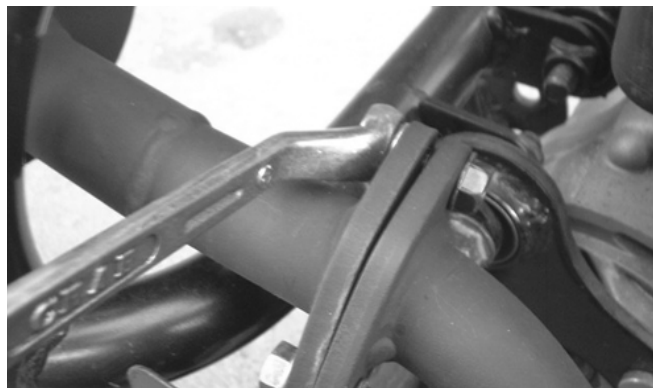

DSC02023

5. Install the intake manifold and the insulator. Tighten the two flange nuts to specifications.

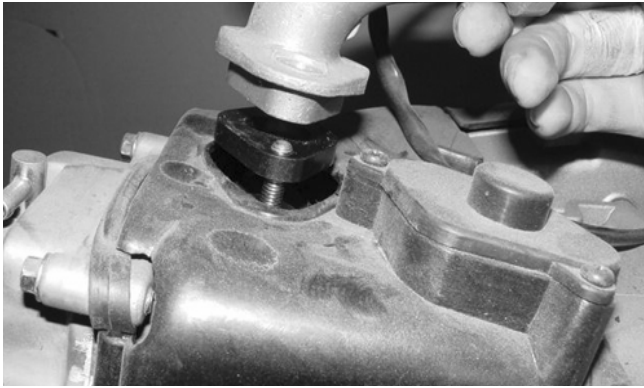

DSC02043



DSC02099

6. Install the carburetor (see Section 4 - Carburetor in this manual).
7. Install the air filter housing to frame. Tighten the three cap screws to specifications.

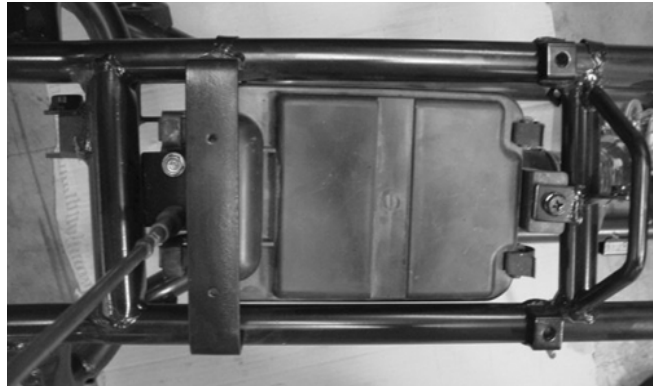

DSC02103

8. Install the gas tank and secure with two cap screws; then fill with appropriate-grade gasoline.
9. Connect the ground wire to the drive belt cover.
10. Connect the battery positive cable first; then the negative cable.

**CAUTION**  
At this point, assure that the engine and transmission are full of recommended lubricants.

11. Start the engine and allow to warm up; then check for lubricant leaks and proper engine/transmission operation.

**3**



# SECTION 4 - FUEL/LUBRICATION

---

---

## TABLE OF CONTENTS

---

Carburetor Specifications .....	4-2
Carburetor Schematic .....	4-2
Carburetor .....	4-2
Throttle Cable Free-Play .....	4-7
Engine RPM (Idle) .....	4-7
Gas Tank .....	4-7
Fuel Valve .....	4-9
Gas/Vent Hoses .....	4-9
Oil Pump Assembly .....	4-9
Oil Screen/Filter .....	4-9

## Carburetor Specifications

ITEM	
Type	Keihin PTE
Main Jet	80
Throttle Valve Cutaway	3.0
Slow Jet	40
Pilot Screw Setting (turns)	1 3/8
Needle Jet	3.4/2.5
Jet Needle	NBSD-3
Idle RPM	1700
Needle Valve/Seat	1.6
Float Arm Height	10.2 mm (0.40 in.)
Throttle Cable Free-Play (at lever)	6.0 mm (0.25 in.)

## Carburetor Schematic

### KEY

1. Carburetor Body
2. O-Ring
3. Set Plate
4. Screw w/Washer
5. Choke Assembly
6. Jet Needle
7. Carburetor Cap
8. Gasket
9. Throttle Valve Spring
10. Throttle Valve
11. Needle Clip Plate
12. Needle Clip
13. Needle Jet
14. Vent Hose
15. Clip
16. Idle Adjustment Screw
17. Spring
18. O-Ring
19. Spring
20. Pilot Screw
21. Jet Holder
22. Main Jet
23. Slow Jet
24. Float Chamber Drain Hose
25. Needle Valve
26. Clip
27. Float Assembly
28. Float Pin
29. Float Chamber
30. Gasket
31. Drain Screw
32. O-Ring
33. Clip
34. Screw w/Washer

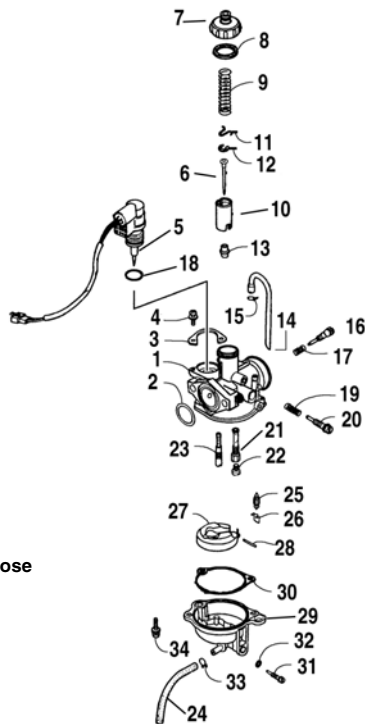

741-045A

## Carburetor

### ⚠ WARNING

Whenever any maintenance or inspection is performed on the fuel system during which there may be fuel leakage, there should be no welding, smoking, open flames, etc., in the area.

### REMOVING

1. Turn the fuel valve to the OFF position; then disconnect the gas hose from the carburetor.



CD590

2. Disconnect the float chamber drain hose and the vent hose from the carburetor.
3. Remove the air intake boot.



CD589

4. Remove the cap screws securing the carburetor to the intake manifold; then remove the carburetor.



CD592

5. Unscrew the carburetor cap; then lift the cap removing the throttle valve, spring, and jet needle. Account for a gasket, a needle clip plate, and a needle clip.

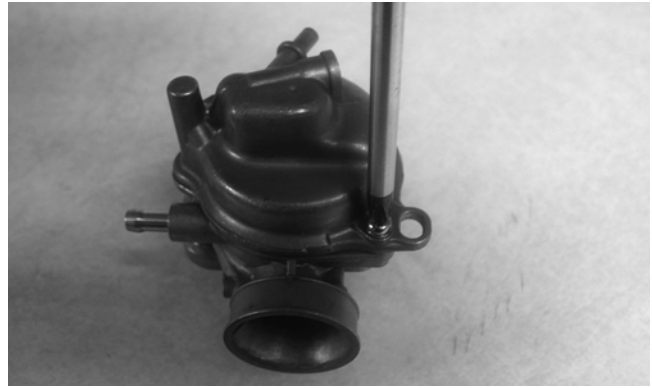

CD600

3. Remove the float pin; then lift the float with needle valve from the carburetor body.

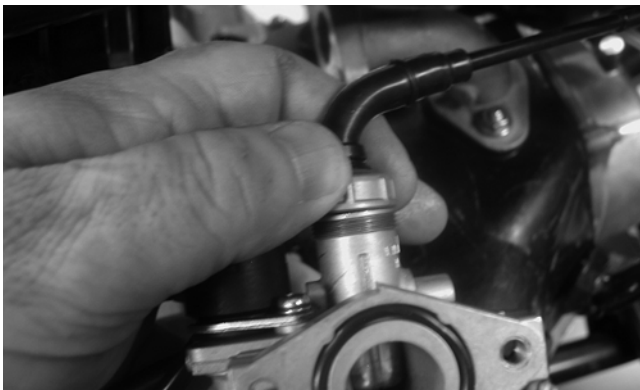

CD594

6. Disconnect the choke assembly connector; then remove the carburetor.

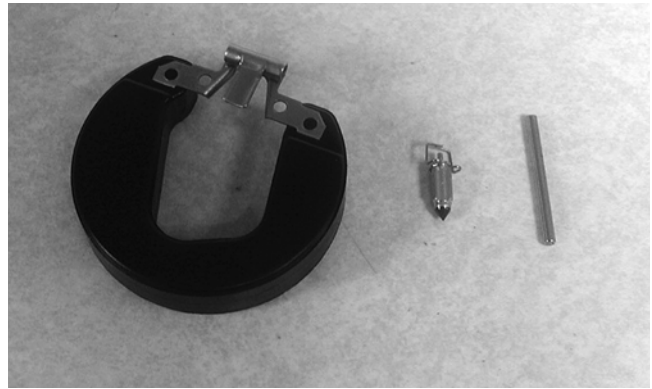

CD603

4. Remove the pilot screw assembly. Account for a spring and O-ring.

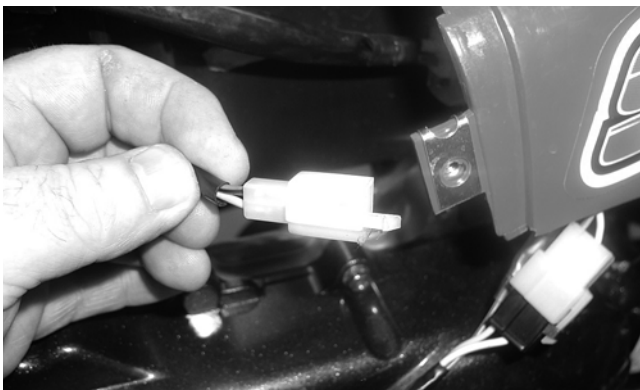

CD591

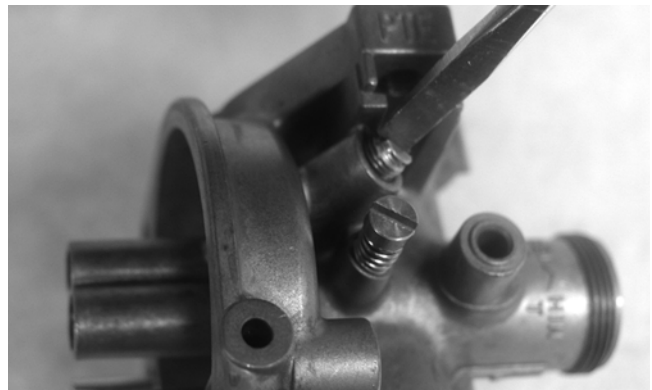

CD608

5. Remove the idle adjustment screw assembly. Account for a spring.

## DISASSEMBLING

1. Remove the two Phillips-head screws securing the choke assembly; then remove the assembly. Account for the washers and the O-ring.
2. Remove the Phillips-head screws securing the float chamber; then remove the chamber. Account for the seal and the washers.

4



CD610

6. Remove the jet holder; then remove the main jet from the jet holder.

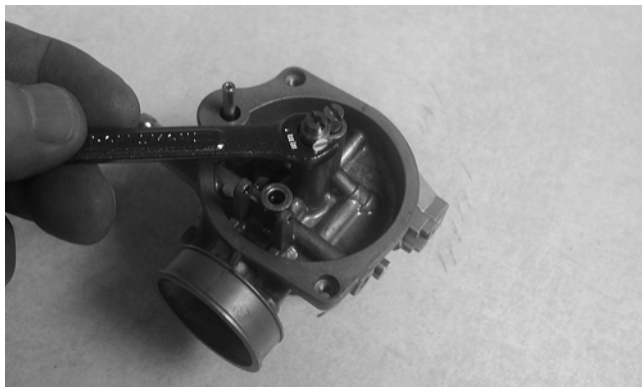

CD604



CD605

7. Remove the slow jet.

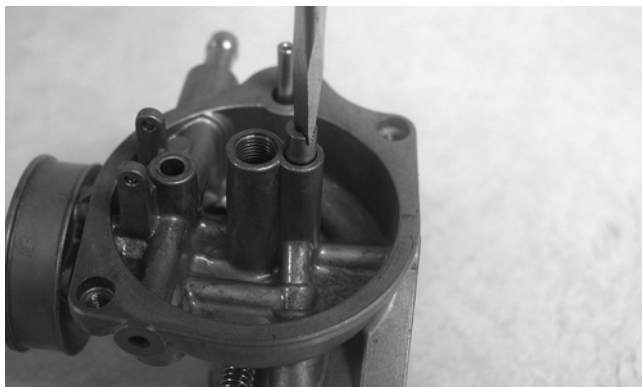

CD606

## CLEANING AND INSPECTING CARBURETOR

■ **NOTE:** Whenever a part is worn excessively, cracked, or damaged in any way, replacement is necessary.

### ⚠ WARNING

When drying components with compressed air, always wear safety glasses.

### ⚠ CAUTION

**DO NOT** place any non-metallic components in parts-cleaning solvent because damage or deterioration will result.

1. Place all metallic components in a wire basket and submerge in carburetor cleaner.
2. Soak for 30 minutes; then rinse with fresh parts-cleaning solvent.
3. Wash all non-metallic components with soap and water. Rinse thoroughly.
4. Dry all components with compressed air only making sure all holes, orifices, and channels are unobstructed.
5. Inspect the carburetor body for cracks, nicks, stripped threads, and any other imperfections in the casting.
6. Inspect float for damage.
7. Inspect gasket, seal, and O-rings for distortion, tears, or noticeable damage.
8. Inspect tips of the jet needle, pilot screw, and the needle valve for wear, damage, or distortion.
9. Inspect the slow jet and main jet for obstructions or damage.

■ **NOTE:** If the slow jet is obstructed, the mixture will be extremely lean at idle and part-throttle operation.

10. Inspect the choke assembly for wear or damage.

## ASSEMBLING

1. Install the slow jet.

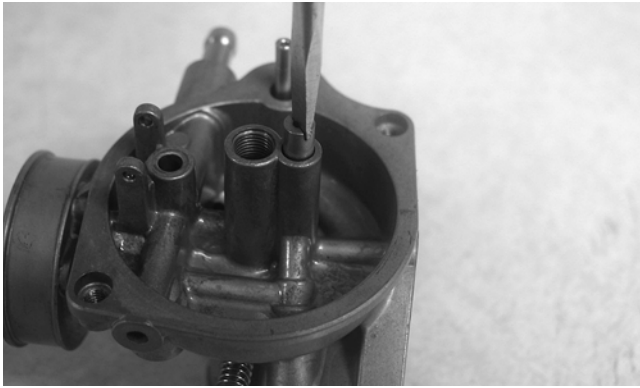

CD606

2. Install the main jet by threading it into the jet holder; then install the jet holder into the carburetor. Tighten both components securely.



CD763

■ **NOTE:** Check float arm height by inverting the carburetor freeing the float arm; then measure with a ruler the height when the float arm is in contact with the needle valve. Float arm height should be 10.2 mm (0.40 in.). To adjust, bend the actuator arm tab.

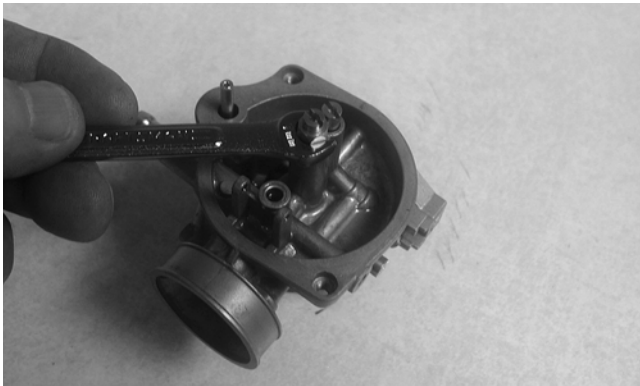

CD604

3. Install the pilot screw with spring and O-ring.

■ **NOTE:** A thin application of lightweight oil will help to seat the O-ring properly.

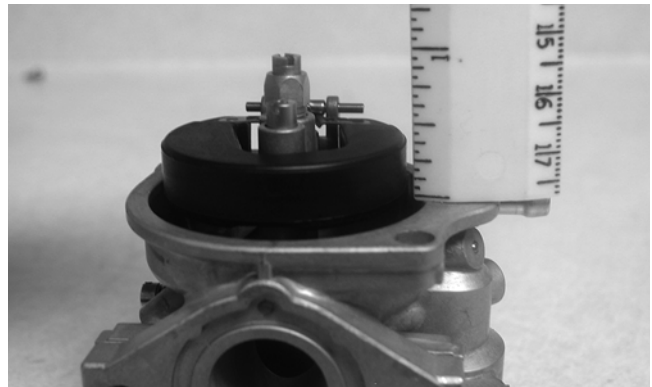

CD615

6. Install the float chamber seal.

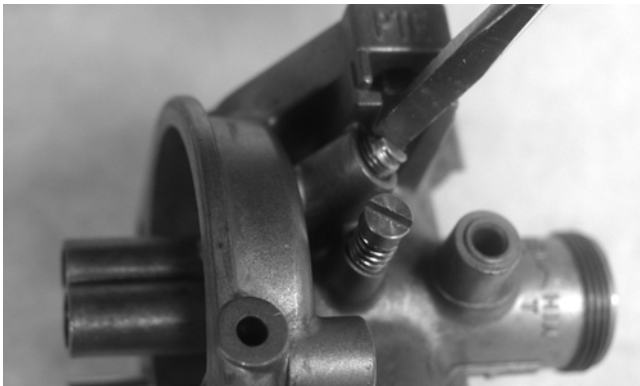

CD608

■ **NOTE:** Turn the pilot screw clockwise until it is lightly seated; then turn it counterclockwise the recommended number of turns as an initial setting.

4. Install the idle adjustment screw with the spring.

5. Install the float and needle valve assembly into the carburetor; then install the float pin.



CD601

7. Place the float chamber into position making sure the seal is properly seated; then secure with the Phillips-head screws and washers.



CD600

8. Install the choke assembly. Tighten the two Phillips-head screws (with washers) securely.

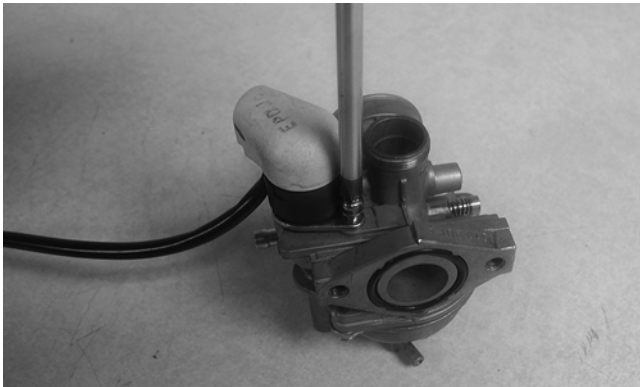

CD598

9. Insert the throttle cable into the top of the cap assembly and through the spring.
10. Compress the spring to expose the end of the throttle cable; then hook the end of the cable into the throttle valve. Release tension on the spring to hold the throttle cable.

## INSTALLING

1. Install the throttle valve into the carburetor with the machined groove engaging the guide pin; then install the jet needle, needle clip, needle clip plate, and gasket.
2. Thread the carburetor cap onto the carburetor; then tighten securely.

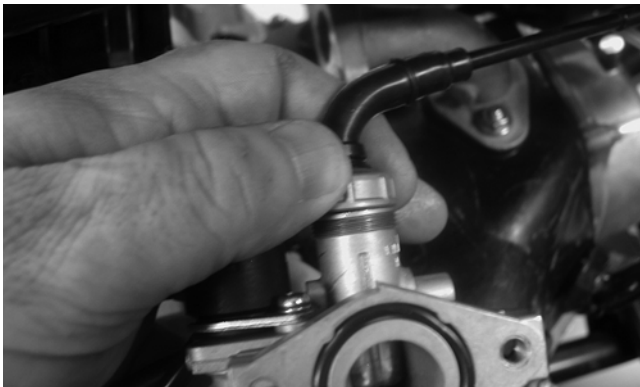

CD594

3. Connect the choke assembly connector.

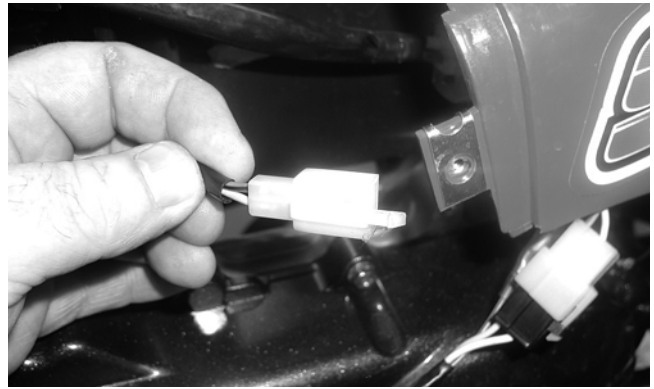

CD591

4. Install the carburetor onto the intake manifold; then tighten the cap screws securely.



CD592

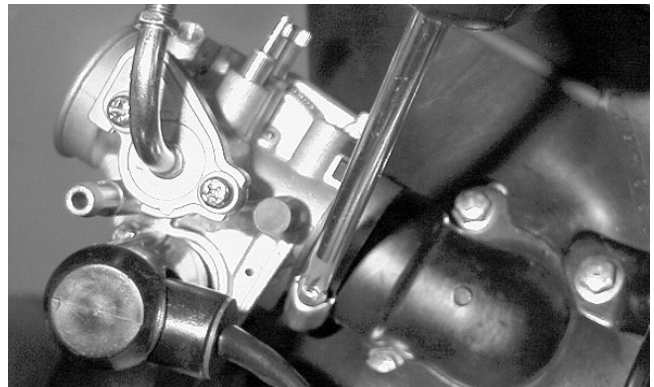

MD2346

5. Install the air intake boot between the air filter and the carburetor. Secure with the clamp.

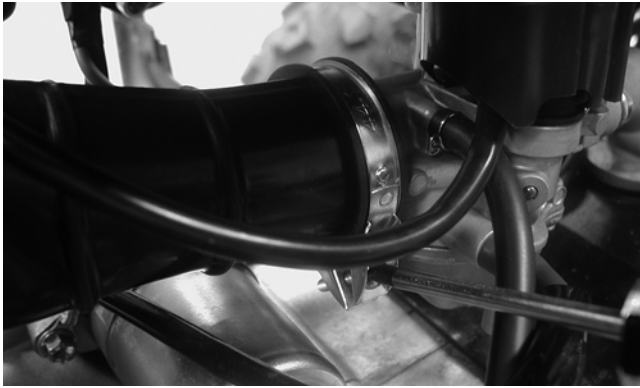

CD589

6. Install the float chamber drain hose and the vent hose to the carburetor.
7. Install the gas hose onto the carburetor.



CD588

## Throttle Cable Free-Play

To check/adjust throttle cable free-play, see Section 2.

## Engine RPM (Idle)

To adjust the idle RPM, see Section 2.

## Gas Tank

### **WARNING**

Whenever any maintenance or inspection is made on the fuel system during which there may be fuel leakage, there should be no welding, smoking, open flames, etc., in the area.

## REMOVING

1. Turn the fuel valve to the OFF position.
2. Remove the gas hose from the carburetor by removing the spring clamp; then funnel the gas hose into an appropriate container of sufficient size to catch all the gas from the gas tank.
3. Turn the fuel valve to the RES position and drain the gas from the gas tank.
4. Remove the seat.



MD2415

**4**

5. Remove the top handlebar clamps.

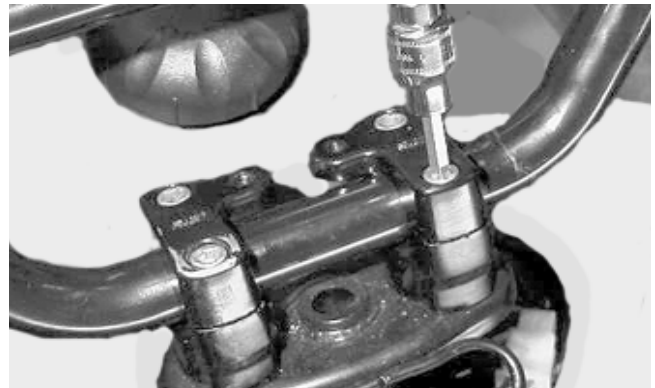

MD2139

6. Carefully lay the handlebar assembly forward on the front fender panel.

■ **NOTE:** To access the gas tank, it is necessary to move the front fender panel, which requires removing the handlebar from its clamp. However, the levers, controls, cables, and wires do not need to be disconnected. The front fender panel and handlebar assembly can be tilted forward far enough to gain access to the gas tank.

7. Remove the four Phillips-head cap screws and six nuts securing the front fender panel. Account for eight washers.
8. Remove the gas tank cap; then tilt the front fender panel and handlebar forward.

9. Remove the two cap screws securing the gas tank; then lift the gas tank and secure it out of the way.

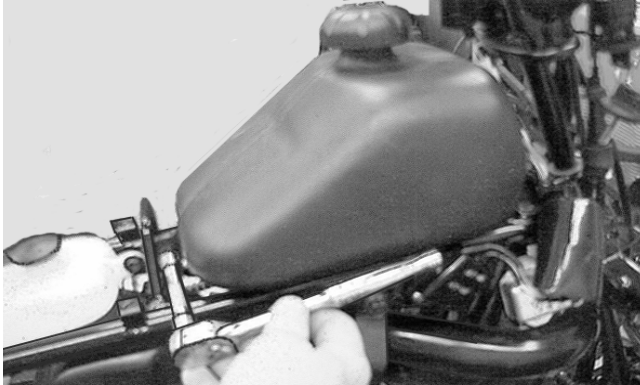

MD2393

10. Remove the gas hoses from the fuel valve noting where each one is attached.



MD1865

■ **NOTE:** Mark the gas hoses for assembling purposes.

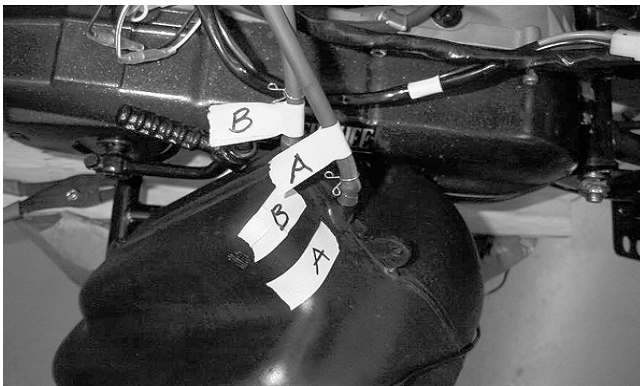

MD1848

## CLEANING AND INSPECTING

■ **NOTE:** Whenever a part is worn excessively, cracked, or damaged in any way, replacement is necessary.

1. Clean all gas tank components with parts-cleaning solvent.
2. Inspect all hoses for cracks or leaks.

3. Inspect gas tank cap and tank for leaks, holes, and damaged threads.

## INSTALLING

1. Place the gas tank into position on the frame; then install the gas hoses to the fuel valve on the frame according to the tags made during removing.

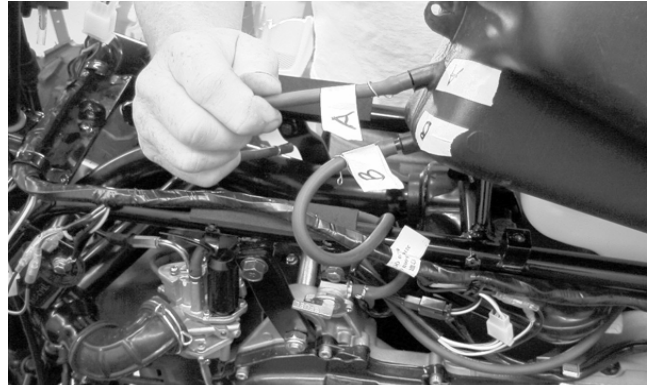

MD2394

2. Install and tighten the gas tank cap screws to specifications (see Section 10).

■ **NOTE:** Do not over-tighten the cap screws securing the gas tank.

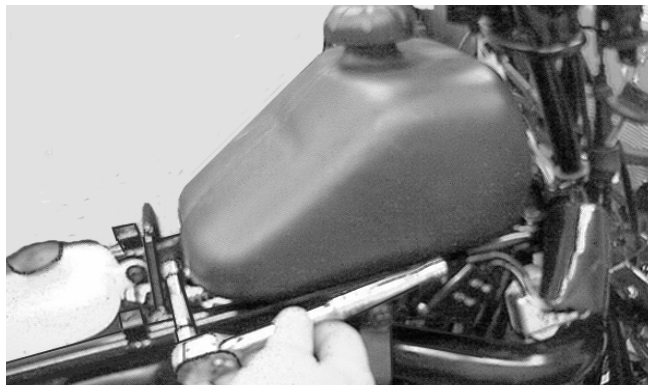

MD2393

3. Install the front fender panel with the eight washers, four Phillips-head cap screws, and six nuts and tighten to specifications (see Section 10).

■ **NOTE:** Do not over-tighten the cap screws and nuts securing the front fender panel.

4. Install the gas tank cap.
5. Install the handlebar aligning the pins in the lower clamps with the locating holes in the bottom of the handlebar. Place the top clamps into position; then tighten the cap screws to specifications (see Section 10).





MD2138

## Fuel Valve

This ATV has a valve mounted on the side of the frame separate from the gas tank. There are three positions: ON, RES, and OFF.

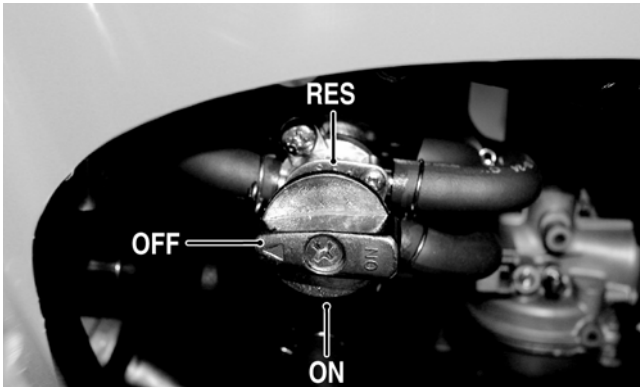

KM043A

In the OFF position, the valve will not allow gasoline to flow to the carburetor. In the ON position (the normal operating position), gasoline will flow from the tank to the carburetor. In this position, 1.3 L (0.34 U.S. gal.) of gasoline will remain in the tank as a reserve quantity. Moving the valve to the RES position will allow the operator to use the remaining gasoline in the tank. When turning the valve to any of the three positions, be sure the indicator is pointed directly at the position desired.

## REMOVING/INSPECTING

### ⚠ WARNING

Drain the gas tank prior to this procedure.

1. Remove the cap screw securing the valve to the frame; then pull the valve out far enough to gain access to the three gas hoses (two to the gas tank, one to the carburetor).
2. Remove the gas hoses from the valve by releasing the spring clamps.
3. Inspect for and remove any obstructions in the valve.

## INSTALLING

1. Install the gas hoses onto the valve with the spring clamps.
2. Place the valve into position on the frame and secure with the cap screw. Tighten to specifications (see Section 10).

4

## Gas/Vent Hoses

Replace the gas hoses every two years. Damage from aging may not always be visible. Do not bend or obstruct the routing of the carburetor vent hose. Make certain that the vent hose is securely connected to the carburetor and the opposite end is always open.

## Oil Pump Assembly

For complete servicing of the oil pump, see Disassembling Engine/Transmission, Servicing Engine Components, and Assembling Engine/Transmission in Section 3.

## Oil Screen/Filter

For complete servicing of the oil screen/filter, see Section 2 - Engine Oil.

# SECTION 5 - ELECTRICAL SYSTEM

---

---

## TABLE OF CONTENTS

---

Specifications .....	5-2
Testing Electrical Components .....	5-2
Timing Sensor .....	5-2
CDI/Ignition Coil .....	5-2
Stator/Magneto Coil .....	5-3
Choke Circuit.....	5-3
Battery .....	5-3
Brakelight Switch.....	5-3
Fuse .....	5-4
Ignition Coil .....	5-4
Ignition Switch .....	5-4
Handlebar Control Switches.....	5-5
Magneto Assembly.....	5-5
Starter Motor .....	5-6
Regulator/Rectifier .....	5-6
Ignition Timing.....	5-6

## Specifications

IGNITION	
Spark Plug Type	CR7HSA
Spark Plug Gap	0.6-0.7 mm (0.024-0.028 in.)
Spark Plug Cap	4725-5775 ohms
Ignition Coil Resistance	(primary) Less than 1 ohm (terminal to terminal) (secondary) 2830-3170 ohms (high tension - plug cap removed - to ground)
MAGNETO	
Timing Sensor (peak voltage)	1.2-2.0 DC volts (blue to ground)
(resistance)	80-160 ohms (blue to ground)
Regulator/Rectifier	12.1-15.2 DC volts @ 3000 RPM (white to black)
CDI/Ignition Coil	(peak voltage) 190-282 DC volts (black/yellow to green)
Stator Coil	(no load) 16.0-19.5 AC volts @3000 RPM (yellow to white)
Magneto Coil Resistance	Less than 1 ohm (yellow to white)
Choke Circuit	(voltage) 4.0-5.5 AC volts (yellow to green/black)

## Testing Electrical Components

All of the electrical tests should be made using the Fluke Model 73 Multimeter (p/n 0644-191). If any other type of meter is used, readings may vary due to internal circuitry. When troubleshooting a specific component, always verify first that the fuse is good, that the bulb is good, that the connections are clean and tight, that the battery is fully charged, and that all appropriate switches are activated.

■ **NOTE:** For absolute accuracy, all tests should be made at room temperature (approximately 68° F).

## Timing Sensor

Disconnect the single connector adjacent to the AC generator plug.

### PEAK VOLTAGE

■ **NOTE:** All of the peak voltage tests should be made using the Fluke Model 73 Multimeter (p/n 0644-191) with Peak Voltage Reading Adapter (p/n 0644-307). If any other type of tester is used, readings may vary due to internal circuitry.

■ **NOTE:** The battery must be at full charge for this test.

1. Set the meter selector to the DC Voltage position.
2. Connect the red tester lead to the blue wire; then connect the black tester lead to a suitable ground.
3. Crank the engine over using the electric starter. The meter must read 1.2-2.0 volts.

### RESISTANCE

1. Set the meter selector to the OHMS position.
2. Connect the red tester lead to the blue wire; then connect the black tester lead to a suitable ground.
3. The meter must read 80-160 ohms.

## CDI/Ignition Coil

Disconnect the wires at the coil.

### PEAK VOLTAGE

■ **NOTE:** All of the peak voltage tests should be made using the Fluke Model 73 Multimeter (p/n 0644-191) with Peak Voltage Reading Adapter (p/n 0644-307). If any other type of tester is used, readings may vary due to internal circuitry.

■ **NOTE:** The battery must be at full charge for this test.

1. Set the meter selector to the DC Voltage position.

2. Connect the red tester lead to the black/yellow wire; then connect the black tester lead to the green wire.
3. Crank the engine over using the electric starter. The meter must read 190-282 volts.

---

---

## Stator/Magneto Coil

---

Disconnect the two-wire connector in front of the steering post.

### VOLTAGE (No Load)

■ **NOTE:** The battery must be at full charge for this test.

1. Set the meter selector to the AC Voltage position.
2. Connect the red tester lead to the yellow wire; then connect the black tester lead to the white wire.
3. With the rear axle supported and the wheels off the floor, start the engine and run at 3000 RPM or to the RPM limiter. The meter must read 16.0-19.5 volts.

### RESISTANCE

1. Set the meter selector to the OHMS position.
2. Connect the red tester lead to the yellow wire; then connect the black tester lead to the white wire.
3. The meter must less than 1 ohm.

---

---

## Choke Circuit

---

Disconnect the white two-pin connector adjacent to the steering post.

### CHOKE VOLTAGE

■ **NOTE:** The battery must be at full charge for this test.

1. Set the meter selector to the AC Voltage position.
2. Connect the red tester lead to the yellow wire; then connect the black tester lead to the green/black wire.

3. Crank the engine over using the electric starter. The meter must read 4.0-5.5 volts.

---

---

## Battery

---

For battery-related information, see Section 2.

---

---

## Brakelight Switch

---

The switch connector is the two individual single connectors located beneath the left-front fender.

■ **NOTE:** The ignition switch must be in the ON position.

### VOLTAGE (Wiring Harness Connector)

1. Set the meter selector to the DC Voltage position; then turn the ignition switch to the ON position.
2. Connect the red tester lead to the green/yellow wire; then connect the black tester lead to a suitable ground.
3. The meter must read battery voltage.

■ **NOTE:** If the meter reads no battery voltage, troubleshoot the battery, fuse, switch, or the main wiring harness.

■ **NOTE:** If the meter reads battery voltage, the main wiring harness is good; test the switch/component, the connector, and the switch wiring harness for resistance.

### RESISTANCE (Brakelight Switch Connector)

 **CAUTION**

Always disconnect the battery when performing resistance tests to avoid damaging the multimeter.

■ **NOTE:** The brake lever must be compressed for this test. Also, the ignition switch must be in the OFF position.

1. Set the meter selector to the OHMS position.
2. Connect the red tester lead to the black wire; then connect the black tester lead to the green/yellow wire.

3. When the lever is compressed, the meter must read less than 1 ohm.

■ **NOTE:** If the meter reads more than 1 ohm of resistance, troubleshoot or replace the switch/component, the connector, or the switch wiring harness.

---

---

## Fuse

---

### CAUTION

Always disconnect the battery when performing resistance tests to avoid damaging the multimeter.

1. Set the meter selector to the OHMS position.
2. Connect the red tester lead to one spade end of the fuse; then connect the black tester lead to the other spade end.
3. The meter must read less than 1 ohm resistance. If the meter reads open, replace the fuse.

■ **NOTE:** Make sure the fuse is returned to its proper position according to amperage.

---

---

## Ignition Coil

---

The ignition coil is attached to the upper frame behind the left-side of the front fender panel. The coil can be accessed inside the front-left fender well.

### CAUTION

Always disconnect the battery when performing resistance tests to avoid damaging the multimeter.

■ **NOTE:** For these tests, the meter selector should be set to the OHMS position.

### PRIMARY WINDING RESISTANCE

1. Disconnect the black/yellow and green wires from the coil.
2. Connect the red tester lead to one terminal; then connect the black tester lead to the other terminal.
3. The meter must read less than 1 ohm.

■ **NOTE:** If the meter does not read as specified, replace ignition coil.

### SECONDARY WINDING RESISTANCE

1. Connect the red tester lead to the high tension lead (plug cap removed); then connect the black tester lead to a suitable ground.
2. The meter must read 2830-3170 ohms.

■ **NOTE:** If the meter does not read as specified, replace the ignition coil.

### SPARK PLUG CAP RESISTANCE

1. Connect the red tester lead to one end of the cap; then connect the black tester lead to the other end of the cap.
2. The meter must read 4725-5775 ohms.

■ **NOTE:** If the meter does not read as specified, replace the spark plug cap.

---

---

## Ignition Switch

---

The connector is accessible below the front fender panel in front of the steering post.

### VOLTAGE

■ **NOTE:** Perform this test on the harness side of the connector.

1. Set the meter selector to the DC Voltage position.
2. Connect the red meter lead to the red wire; then connect the black meter lead to a suitable ground.
3. Meter must read battery voltage.

■ **NOTE:** If the meter reads no battery voltage, troubleshoot the battery, fuse, or the main wiring harness.

### RESISTANCE

### CAUTION

Always disconnect the battery when performing resistance tests to avoid damaging the multimeter.

■ **NOTE:** Perform this test on the switch side of the connector.

1. Turn the ignition switch to the ON position.
2. Set the meter selector to the OHMS position.

3. Connect the red tester lead to the red wire; then connect the black tester lead to the green/yellow wire.
4. The meter must read less than 1 ohm.
5. Connect the red tester lead to the red wire; then connect the black tester lead to the green wire.
6. The meter must read less than 1 ohm.
7. With the switch in the OFF position, connect the red tester lead to the red wire and the black tester lead to each of the remaining wires. The meter must read an open circuit on both wires.

■ **NOTE:** If the meter reads more than 1 ohm of resistance, troubleshoot or replace the switch/component, the connector, or the switch wiring harness.

---

---

## Handlebar Control Switches

---

The connector is in front of the steering post. The connector is accessible beneath the front fender.

■ **NOTE:** These tests should be made on the switch side of the connector.

**⚠ CAUTION**

Always disconnect the battery when performing resistance tests to avoid damaging the multimeter.

### RESISTANCE (Starter Button)

1. Set the meter selector to the OHMS position.
2. Connect the red tester lead to the yellow/white wire; then connect the black tester lead to the green wire.
3. With the starter button depressed, the meter must read less than 1 ohm.
4. With the starter button released, the meter must read an open circuit.

■ **NOTE:** If the meter does not read as specified, replace the switch/component, connector, or switch harness.

### RESISTANCE (Emergency Stop)

1. Set the meter selector to the OHMS position.

2. Connect the red tester lead to the blue/yellow wire; then connect the black tester lead to the green wire.
3. With the switch in the OFF position, the meter must read an open circuit.
4. With the switch in the RUN position, the meter must read less than 1 ohm.

■ **NOTE:** If the meter reads more than 1 ohm of resistance, troubleshoot or replace the switch/component, the connector, or the switch wiring harness.

---

---

## Magneto Assembly

---

### REMOVING

1. Disconnect the battery.

**⚠ CAUTION**

Always disconnect the negative battery cable from the battery first; then disconnect the positive cable.

2. Remove the flywheel from the engine (see Section 3).
3. Remove the stator and timing sensor from the stator plate.

### INSPECTING

1. Check stator for signs of overheating, broken wires, or other damage.
2. Check the timing sensor for broken wires or signs of damage.

### INSTALLING

1. Install the timing sensor and stator onto the stator plate. Secure with cap screws lightly coated with red Loctite #271. Tighten securely.
2. Install the flywheel (see Section 3).

---

---

## Starter Motor

---

■ **NOTE:** The starter motor is not a serviceable component. If the motor is defective, it must be replaced.

### REMOVING

1. Disconnect the battery.

 **CAUTION**

**Always disconnect the negative battery cable from the battery first; then disconnect the positive cable.**

2. Remove the starter motor from the engine (see Section 3).
3. Remove the nut securing the positive cable to the starter; then remove the cable from the starter. Account for an O-ring.

### INSTALLING

Install the starter motor (see Section 3).

---

---

## Regulator/Rectifier

---

The regulator/rectifier is located near the battery.

### VOLTAGE

1. Set the meter selector to the DC Voltage position.
2. Test between the black and white wires (with the regulator/rectifier plugged in).
3. With the engine running at a constant 3000 RPM, the meter must read 12.1-15.2 volts.

---

---

## Ignition Timing

---

The ignition timing cannot be adjusted; however, verifying ignition timing can aid in troubleshooting other components.

To verify ignition timing, see Section 2.

# SECTION 6 - DRIVE SYSTEM

---

---

## TABLE OF CONTENTS

---

Drive System .....	6-2
Reduction Gears .....	6-2
Drive Chain/Sprockets.....	6-4
Rear Hub/Drive Axle .....	6-7
Front Hub .....	6-10
Brake Systems .....	6-12



---

---

## Drive System

---

■ **NOTE:** Critical torque specifications are located in Section 10.

---

---

## Reduction Gears

---

■ **NOTE:** The engine/transmission must be removed for this procedure (see Section 3).

### DISASSEMBLING

1. Remove the five Allen-head cap screws securing the cover to the gear reduction case. Discard the gasket.

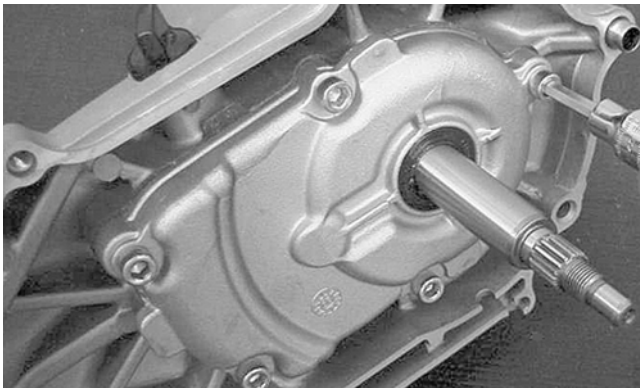

MD1890

■ **NOTE:** There will be residual lubricant inside the gear reduction case when the cover is removed.

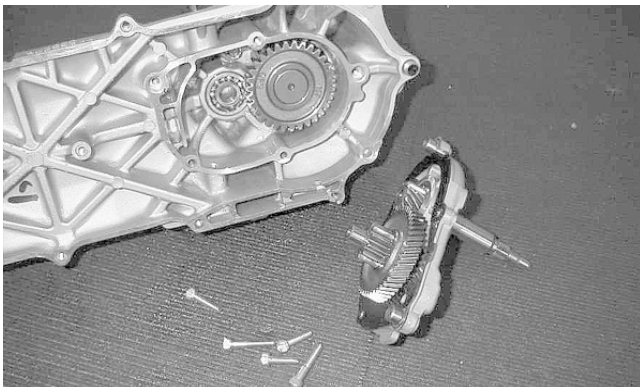

MD1892

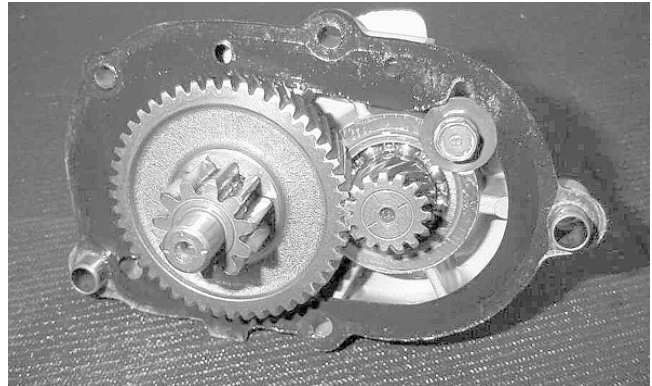

MD1891

2. Remove the circlip, bearing, and inner seal from the output shaft side of the gear reduction case.



MD1918



MD1920

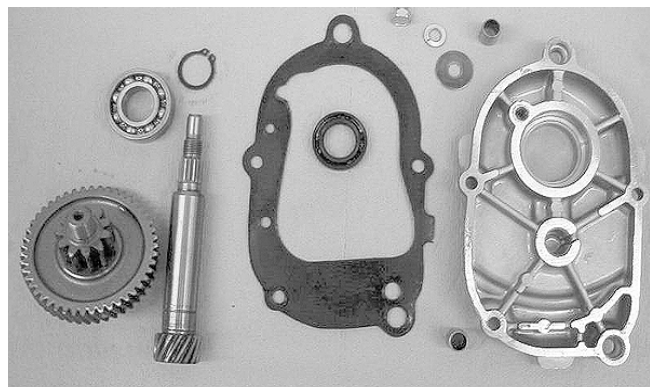

MD1932

## ASSEMBLING

1. In order, install the output shaft seal, bearing, and circlip. Install the seal with the lip facing inwards using a seal driver.



MD1920



MD2065



MD2066

2. If removed, install the input shaft bearing.

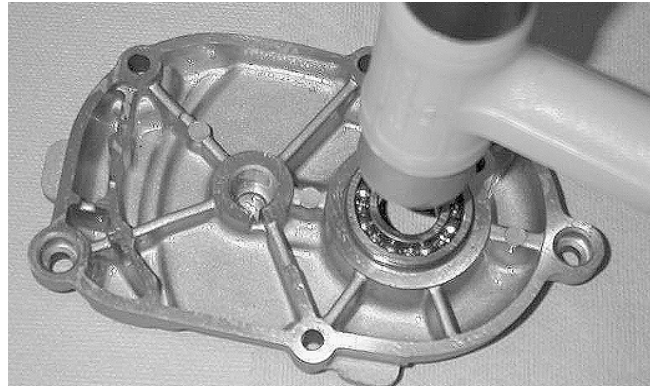

MD1927

3. Install the bearing retaining washer and the 6 mm cap screw. Tighten to specifications.

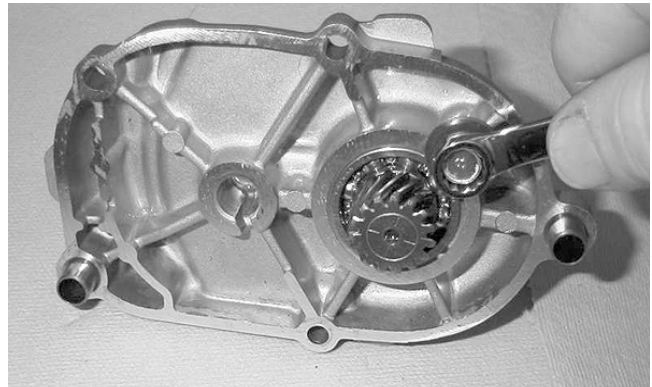

MD1926

4. Install the intermediate gear and the gear reduction case cover gasket. Account for the two dowel pins on the cover and install the cover using five Allen-head cap screws. Tighten to specifications.

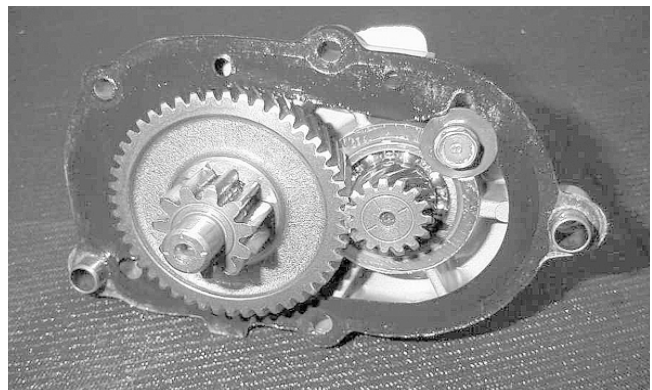

MD1891

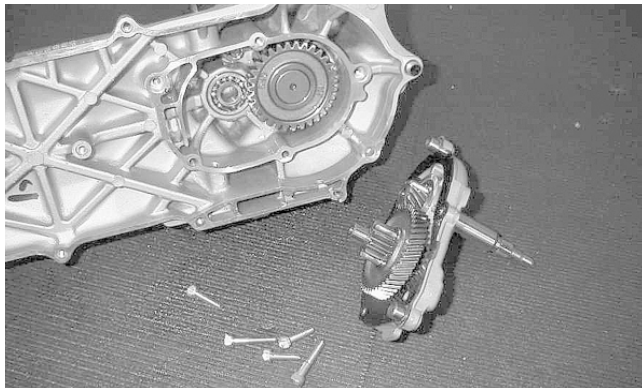

MD1892

■ **NOTE:** The two long cap screws are installed in the same holes as the dowel pins.

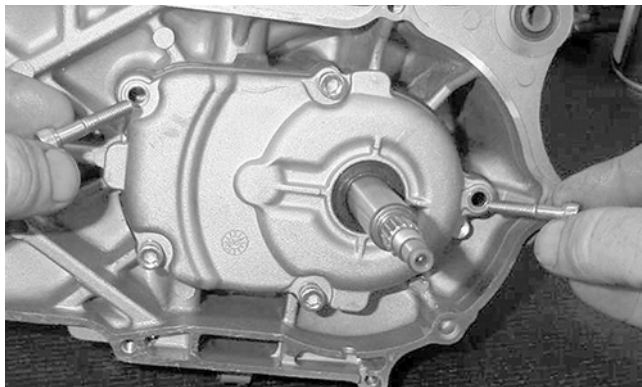

MD2064

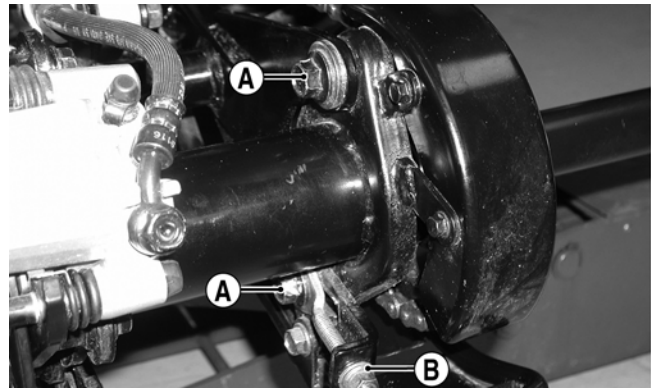

KM217A

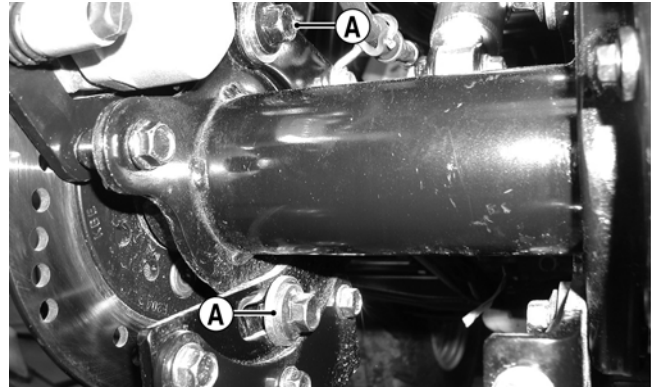

KM212A

2. Tighten the adjuster nut (B) on the adjusting bolt until approximately 30 mm (1.18 in.) of slack is present at mid-span of the chain.

---

---

## Drive Chain/Sprockets

---

---

### CHECKING DRIVE CHAIN AND SPROCKETS

The following drive system components should be inspected periodically to ensure proper operation.

- A. Chain (excessive stretch or slack).
- B. Sprockets (excessive wear/hooks, missing or broken teeth).

### ADJUSTING DRIVE CHAIN

1. Loosen the four cap screws (A) securing the rear axle housing to the rear swing arm.

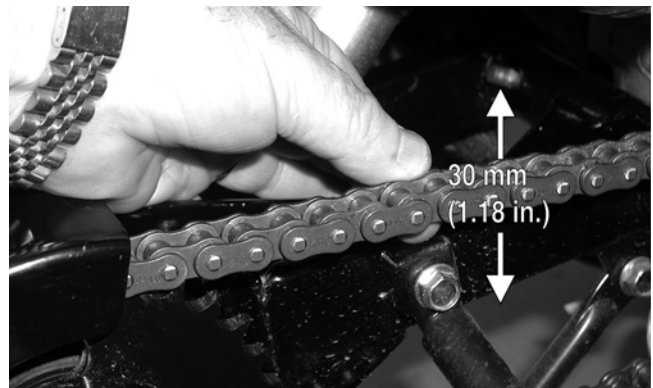

KM218A

3. Tighten the four cap screws.

### REMOVING DRIVE CHAIN

1. Remove the drive chain master link clip.

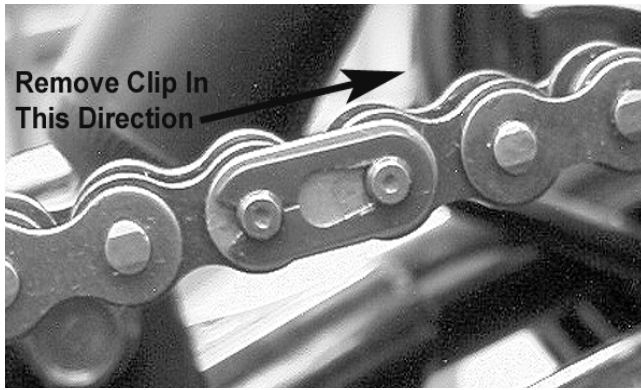

MD2357

2. Remove the link plate and link noting the position of the O-rings; then remove the chain.

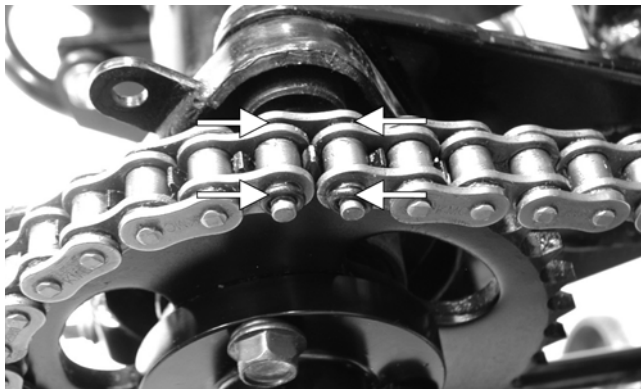

KM238A

### INSTALLING DRIVE CHAIN

1. Place the drive chain into position on the sprockets.
2. Making sure to place the O-rings into position, install the master link, link plate, and link clip.



KM238A

■ **NOTE:** Make sure the closed end of the master link clip faces the direction of the rotation of the chain.



MD1854

### REMOVING FRONT (COUNTERSHAFT) SPROCKET

1. With the chain installed and with the rear brake applied, remove the two cap screws securing the sprocket to the countershaft. Account for a washer.
2. Remove the drive chain (see Removing Drive Chain in this sub-section).
3. Remove the countershaft sprocket. Account for a washer.

### INSTALLING FRONT (COUNTERSHAFT) SPROCKET

1. Place the countershaft sprocket over the countershaft.
2. Install the drive chain (see Installing Drive Chain in this sub-section).
3. Install the washer and two cap screws.
4. With the rear brake lever lock applied, tighten the cap screws to specifications.

### REMOVING REAR SPROCKET

1. Secure the ATV on a support stand to elevate the right rear wheel.

#### **⚠ WARNING**

**Make sure the ATV is solidly supported on the support stand to avoid injury.**

2. Remove the cotter pin from the castle nut on the right rear wheel hub.
3. Remove the wheel hub castle nut; then slide the wheel and hub off together. Account for the washer.



MD2363

4. Remove the drive chain master link clip, link plate, and master link; then allow the drive chain to roll off the rear sprocket. Account for four O-rings on the master link.

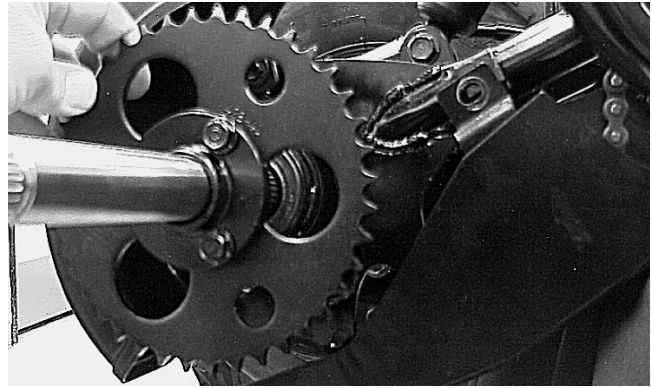

MD2368

8. Remove three cap screws securing the sprocket to the sprocket carrier; then remove the sprocket.

### INSTALLING REAR SPROCKET

1. Position the sprocket onto the sprocket carrier; then install the three cap screws securing the sprocket to the sprocket carrier. Tighten the cap screws to specifications.
2. Slide the rear sprocket carrier and rear sprocket onto the axle and into position next to the axle housing.

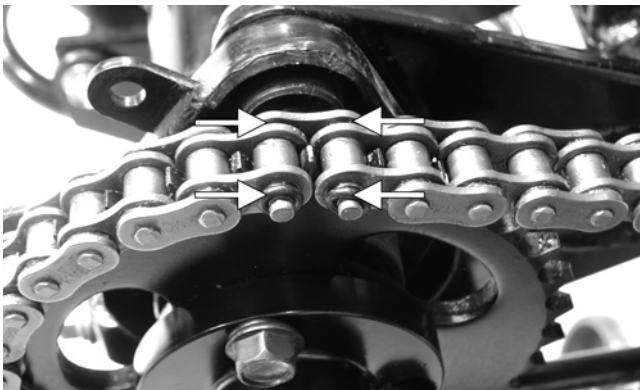

KM238A

■ **NOTE:** It is not necessary to completely remove the drive chain in order to remove the rear sprocket.

5. Slide the right-side axle spacer off the axle.

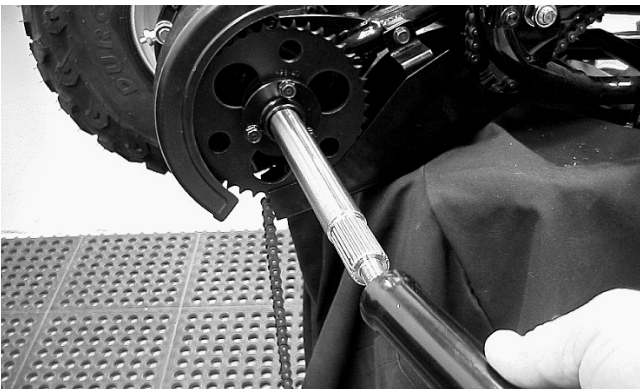

MD2365

6. Remove the two cap screws securing the chain guard to the axle housing.
7. Slide the rear sprocket carrier and rear sprocket off the axle.



MD2369

3. Slide the right-side axle spacer onto the axle.
4. Install the drive chain (see Installing Drive Chain in this sub-section).
5. Install the chain guard and secure with two cap screws. Tighten securely.
6. Install the right rear wheel and hub as a unit.
7. Install the washer and castle nut. Tighten the castle nut to specifications.



MD2364

8. Install a new cotter pin.

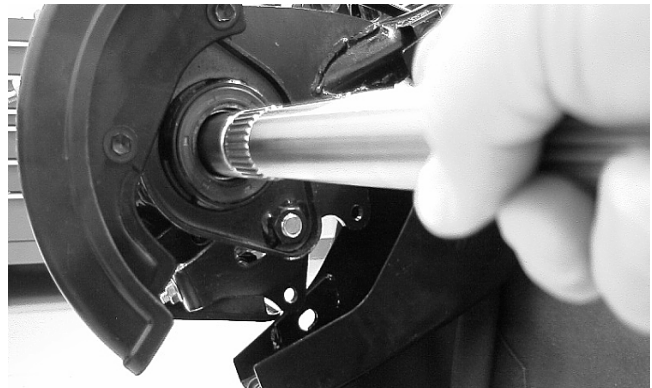

MD2373

**AT THIS POINT**

If the technician's objective is to service/replace the drive axle, the axle housing does not have to be removed from the swing arm. The axle can be pulled out the right side of the axle housing. Axle bearings can also be replaced without removing the axle housing from the swing arm, but the rear axle housing cover and brake hub will need to be removed. The axle housing should only be removed if it needs to be serviced or replaced.

## Rear Hub/Drive Axle

### REMOVING REAR HUB/DRIVE AXLE

1. Secure the ATV on a support stand to elevate the rear wheels.

**⚠ WARNING**

**Make sure the ATV is solidly supported on the support stand to avoid injury.**

2. Remove the cotter pins from the castle nuts on the rear wheel hubs.
3. Remove the rear wheel hub castle nuts; then slide the rear wheels and hubs off together. Account for the washers.
4. Remove the drive chain (see Removing Drive Chain sub-section).
5. Remove the rear sprocket (see steps 5-8 of Removing Rear Sprocket sub-section).
6. Remove the drive axle by sliding it out the right side of the axle housing.

■ **NOTE:** Note the difference in the length between the four sets of splines on the axle for installing purposes.

### REMOVING BEARINGS AND SEALS

1. Secure the ATV on a support stand to elevate the rear wheels.

**⚠ WARNING**

**Make sure the ATV is solidly supported on the support stand to avoid injury.**

2. Remove the wheels and hubs (see Removing Rear Hub/Drive Axle in this sub-section).
3. Using an appropriate prying tool, carefully pry out the seals from each side of the axle housing.



KM232

4. Drive out the bearings from the axle housing. Account for center axle housing spacer.

## REMOVING AXLE HOUSING

1. Secure the ATV on a support stand to elevate the rear wheels.

### **WARNING**

**Make sure the ATV is solidly supported on the support stand to avoid injury.**

2. Remove two cap screws securing the brake caliper to the axle housing; then lift the caliper off the disc.

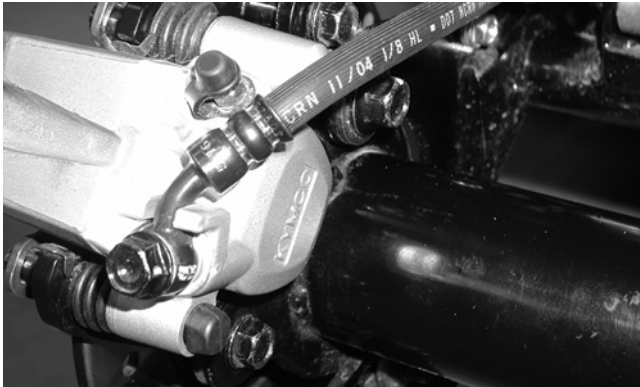

KM207

3. Remove drive chain, wheels, hubs, spacers, and axle as necessary (see Removing Rear Hub/Drive Axle in this sub-section).

■ **NOTE:** Do not remove more components than necessary to perform the intended service. The axle housing will separate from the swing arm with all components attached if necessary.

4. Remove the four cap screws (A) securing the axle housing to the swing arm; then remove the axle housing.

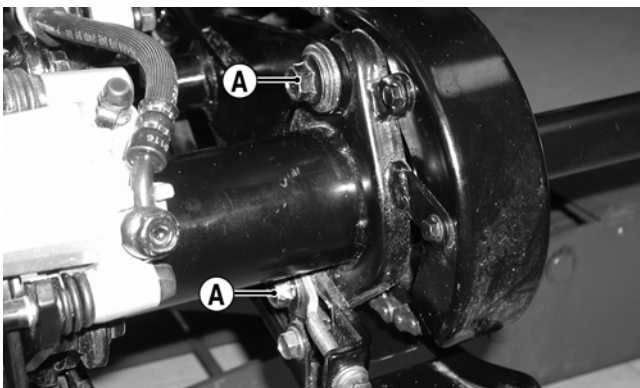

KM217B

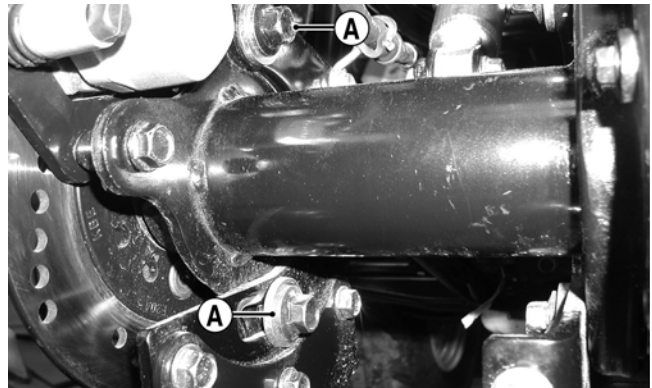

KM212A

## CLEANING AND INSPECTING

■ **NOTE:** Always clean and inspect the drive axle components to determine if any service or replacement is necessary. Replace all components that show signs of wear or damage.

1. Using a clean towel, wipe away any oil or grease.
2. Inspect bearings for smooth operation.
3. Inspect seals for tears, cracks, or deterioration.
4. Inspect splines on axle for damage or wear.
5. Inspect threads on end of axle for damage or stripped threads.
6. Inspect axle for straightness by rolling it on a flat surface and checking for wobble.
7. Inspect axle housing for dents or warpage that might interfere with bearing bore or alignment.

## INSTALLING BEARINGS AND SEALS

1. Using a plastic mallet and bearing driver or appropriate size socket, carefully install the first bearing into the axle housing.

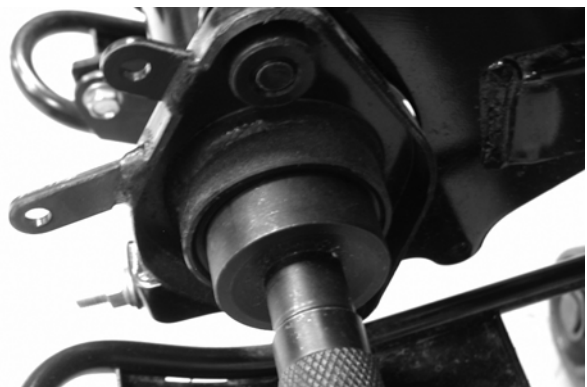

KM226

2. Place the center axle housing spacer in the axle housing; then using a plastic mallet, install the second bearing.

■ **NOTE:** It may be helpful to insert the axle through the previously installed bearing and into the axle housing to align the center axle housing spacer with the bearing bore. Axle installation may be difficult if the spacer is offset from the bearing bore.

3. Apply a light coat of axle bearing grease to the inside (mating surface) of the seals; then using a plastic mallet, install the seals.



KM223

## INSTALLING AXLE HOUSING

1. Position axle housing in swing arm; then install and finger-tighten the four cap screws securing the axle housing to the swing arm.
2. Install the brake caliper to the axle housing.

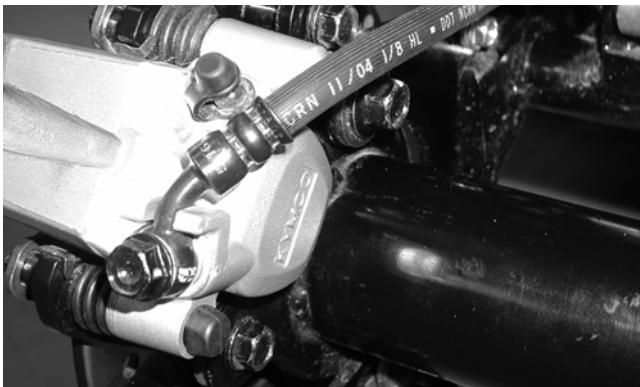

KM207

3. Install the drive chain (see Installing Drive Chain sub-section).
4. Adjust the drive chain slack (see Adjusting Drive Chain sub-section); then tighten the four cap screws (from step 1) to specifications.

## INSTALLING DRIVE AXLE/REAR HUB

1. Slowly slide the axle into the axle housing.

■ **NOTE:** The axle may have to be turned from side-to-side slightly during installing to get the axle through the center axle housing spacer.



MD2374

2. Slide the axle through the brake disc.



KM234

3. Making sure to direct the flared end toward the brake disc, install the left axle spacer over the axle.

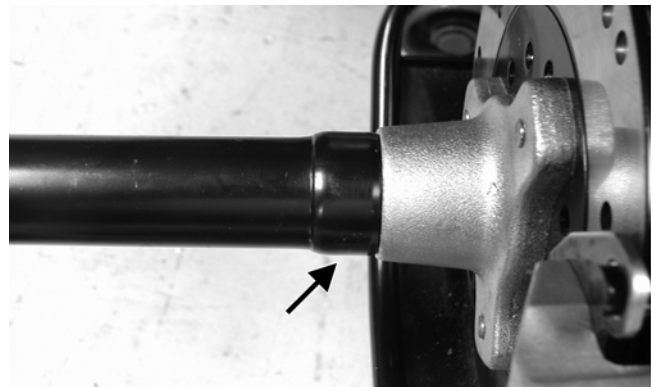

KM237A

4. Install the rear sprocket and sprocket carrier over the right side axle. Tighten the carrier to specifications.



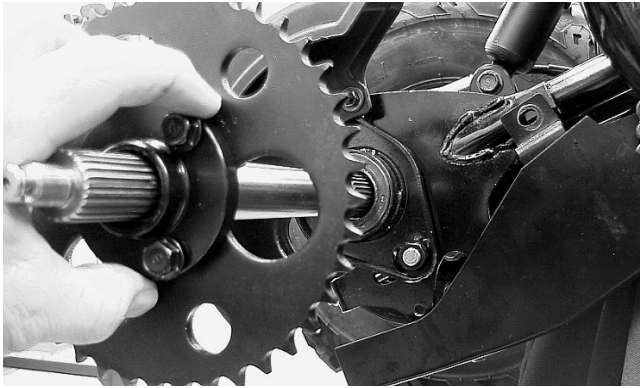

MD2369

5. Making sure to direct the flared end toward the sprocket, install the right axle spacer over the axle.

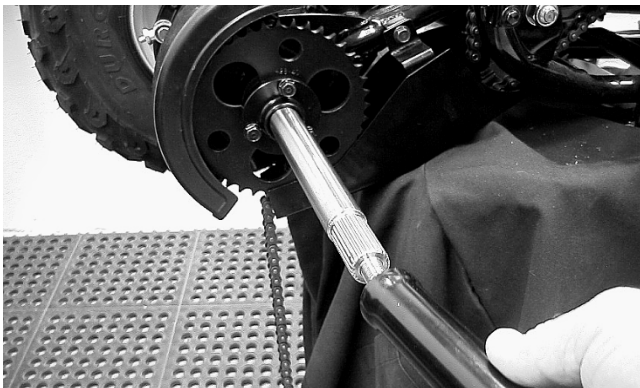

MD2365

6. Install the drive chain (see Installing Drive Chain sub-section).
7. Install the rear wheel/hub assemblies. Tighten the castle nuts to specifications; then install new cotter pins.



MD2364

---

---

## Front Hub

---

### REMOVING HUB

1. Secure the ATV on a support stand to elevate the front wheels; then remove the wheels.

#### **WARNING**

**Make sure the ATV is solidly supported on the support stand to avoid injury.**



MD2421

2. Remove the cotter pin from the castle nut.

■ **NOTE: During installing, a new cotter pin should be installed.**

3. Remove the castle nut securing the hub. Account for a washer.



MD2133

4. Remove the hub assembly. Account for outer hub spacer.
5. Repeat procedure for other hub.

## CLEANING AND INSPECTING

■ **NOTE:** Whenever a part is worn excessively, cracked, or damaged in any way, replacement is necessary.

1. Clean all hub components.
2. Inspect all threads for stripping or damage.
3. Inspect the brake shoes for excessive wear or gouges.
4. Inspect the sealing area of the hub for pits.
5. Inspect the hub splines for signs of wear.
6. Inspect the hub for cracks.
7. Verify that the bearings turn freely.

## REMOVING HUB BEARINGS AND SEALS

1. Carefully pry out inner and outer seals.

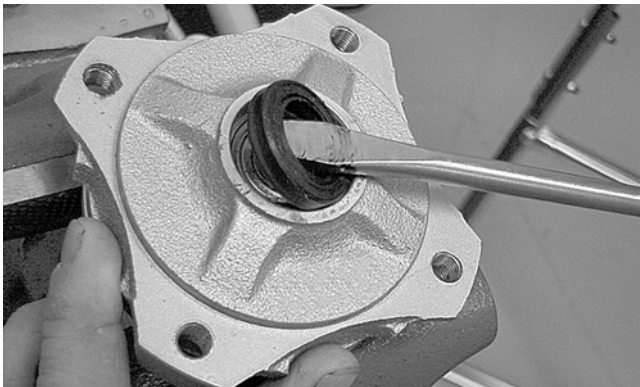

MD2385

2. Drive out the inner and outer bearings. Account for a spacer.

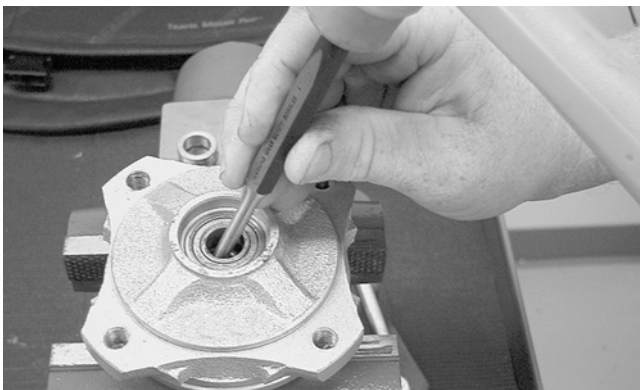

MD2384A

3. Repeat procedure for the other hub.

## INSTALLING HUB BEARINGS AND SEALS

1. Lightly lubricate the bearings with bearing grease; then using a plastic mallet and a bearing driver or appropriate size socket, install the inner bearing into the hub.



MD2382

2. Install the inner hub spacer; then install the outer bearing.
3. Using a plastic mallet, install the inner and outer seals into the hub.

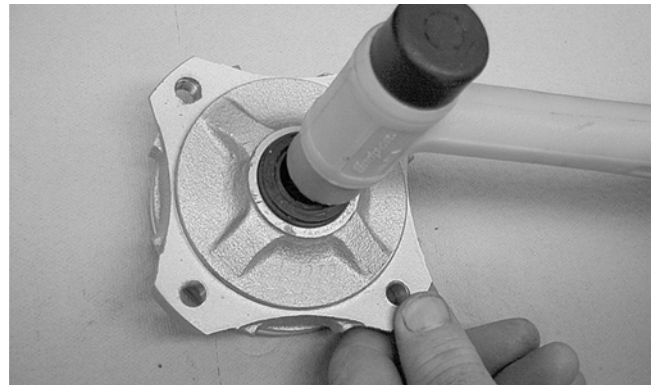

MD2380

4. Repeat procedure for the other hub.

## INSTALLING HUB

1. Lightly lubricate the seals with bearing grease; then install the hub assembly.
2. Install the outer spacer, washer, and castle nut. Tighten the castle nut to specifications; then install a new cotter pin.

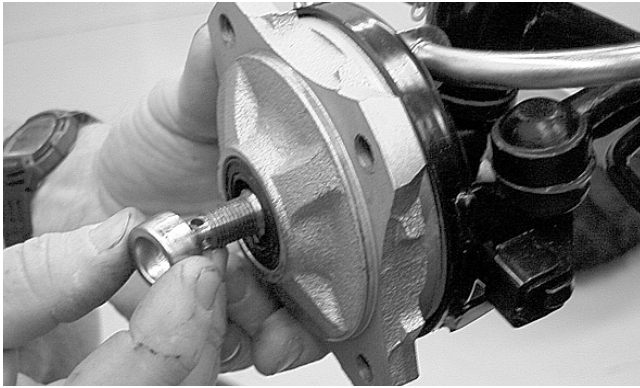

MD2388

3. Install wheel. Tighten the four cap screws to specifications.

4. Repeat procedure for other hub assembly.

---

---

## Brake Systems

---

For information regarding the brake systems, see Section 2.



MD2354

# SECTION 7 - SUSPENSION

---

---

## TABLE OF CONTENTS

---

Suspension .....	7-2
Shock Absorbers .....	7-2
A-Arm .....	7-3
Swing Arm .....	7-6
Wheels and Tires .....	7-8

---

---

## Suspension

---

■ **NOTE:** Critical torque specifications are located in Section 10.

---

---

## Shock Absorbers

---

### REMOVING FRONT SHOCK ABSORBERS

1. Secure the ATV on a support stand to elevate the wheels and to release the load on the suspension.

**⚠ WARNING**

Make sure the ATV is solidly supported on the support stand to avoid injury.

2. Remove the cap screw and self-locking nut securing each front shock absorber to the frame.



MD2131

3. Remove the cap screw and self-locking nut securing each front shock to the A-arms.



MD2132

4. Remove the front shock absorbers.

### REMOVING REAR SHOCK ABSORBER

1. Secure the ATV on a support stand to elevate the wheels and to release the load on the suspension.

**⚠ WARNING**

Make sure the ATV is solidly supported on the support stand to avoid injury.

**⚠ CAUTION**

Additional support stands are necessary to support the rear axle when the shock absorbers are removed or damage may occur.

2. Remove the cap screw securing the rear shock absorber to the frame.



MD2314

3. Remove the cap screw securing the rear shock absorber to the swing arm; then remove the rear shock absorber.



MD2315

4. Compress the shock absorber spring and remove the spring retainer. Remove the spring and spring preload adjuster.

## CLEANING AND INSPECTING

■ **NOTE:** Whenever a part is worn excessively, cracked, or damaged in any way, replacement is necessary.

1. Clean all shock absorber components.
2. Inspect each shock rod for nicks, pits, rust, bends, and oily residue.
3. Inspect all springs, spring retainers, shock rods, dampers, bushings, shock bodies, and eyelets for cracks, leaks, and bends.

## INSTALLING FRONT SHOCK ABSORBERS

1. Place a shock absorber into position on the frame and A-arm and install the two cap screws and self-locking nuts. Tighten the nuts to specifications.



MD2131



MD2132

2. Repeat the procedure for the other front shock absorber.

**CAUTION**  
Do not tighten the nuts beyond the 4.0 kg-m (29 ft-lb) specification or the shock eyelet or mount WILL be damaged.

3. Remove the ATV from the support stand.

## INSTALLING REAR SHOCK ABSORBER

1. Place the spring preload adjuster and spring over the shock absorber. Compress the spring and install the retainer.
2. Place the shock absorber into position on the frame and swing arm and install the two cap screws. Tighten the cap screws to specifications.



MD2314



MD2315

**CAUTION**  
Do not tighten the cap screws beyond the 4.0 kg-m (29 ft-lb) specification or the shock eyelet or mount WILL be damaged.

3. Remove the ATV from the support stand.

## A-Arm

### REMOVING

1. Secure the ATV on a support stand to elevate the front wheel; then remove the wheel.

**WARNING**  
Make sure the ATV is solidly supported on the support stand to avoid injury.

2. Remove the cotter pin, castle nut, and washer; then remove the hub assembly.



MD2133

3. Slide brake backing plate assembly off the spindle shaft and secure it out of the way.
4. Remove the cotter pin from the outer tie rod end; then while holding the flat on the tie rod end, remove the castle nut. Account for a washer.



MD2428

5. Remove the tie rod end from the steering knuckle.
6. Remove the rubber spindle pin boot; then remove the cotter pin and flanged castle nut from the spindle pin. Lower the steering knuckle assembly from the A-arm.



MD2113

7. Remove the cap screw and self-locking nut securing the shock absorber to the A-arm.

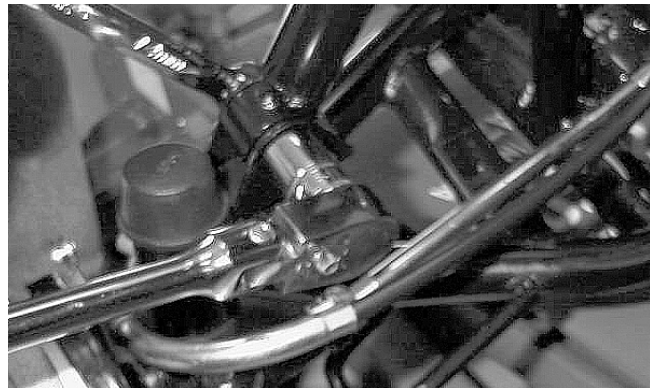

MD2132

8. Remove the cap screws and self-locking nuts securing the A-arm to the frame.

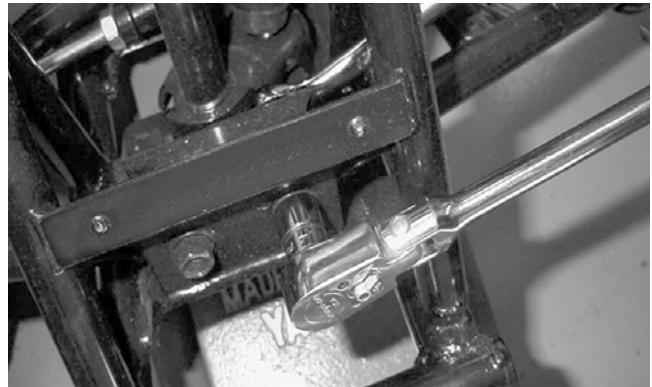

MD2121

9. Remove the A-arm.

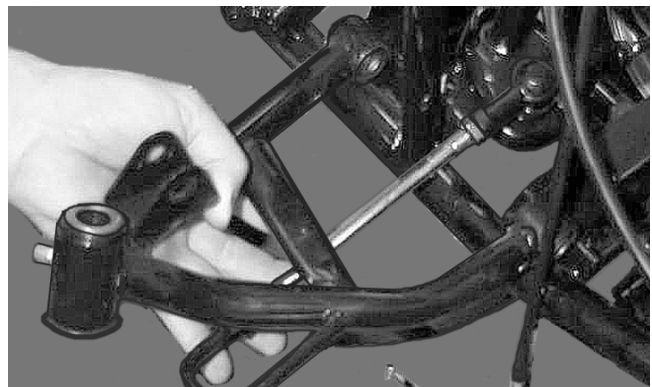

MD2119

## CLEANING AND INSPECTING

■ **NOTE:** Whenever a part is worn excessively, cracked, or damaged in any way, replacement is necessary.

1. Clean all A-arm components in parts-cleaning solvent.
2. Clean the tie rod mounting hole of all residual Loctite, grease, oil, or dirt for installing purposes.
3. Inspect the A-arm for bends, cracks, and worn bushings.

4. Inspect the tie rod mounting holes for cracks or damage.
5. Inspect the frame mounts for signs of damage or wear.

## INSTALLING

■ **NOTE:** During installing, new cotter pins should be installed.

1. Lubricate the A-arm bushings with grease; then install the A-arm into the frame. Install the cap screws and self-locking nuts. Tighten the nuts to specifications.

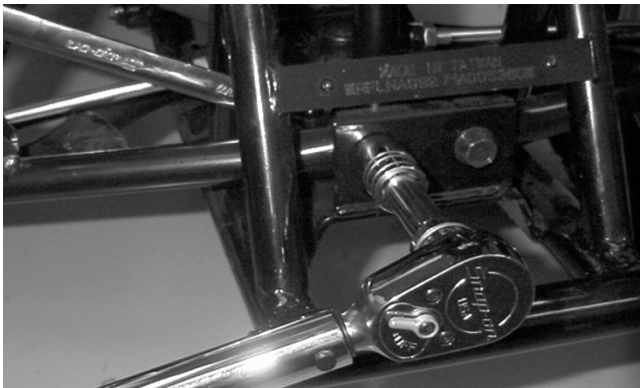

MD2425

2. Secure the shock absorber to the A-arm with the cap screw and self-locking nut. Tighten the nut to specifications.

### ⚠ CAUTION

Do not tighten the nut beyond the 4.0 kg-m (29 ft-lb) specification or the shock eyelet or mount WILL be damaged.



MD2424

3. Lubricate the steering knuckle assembly with grease; then install it into the A-arm and secure with the flanged castle nut. Tighten the nut to specifications; then install a new cotter pin and the rubber spindle pin boot.

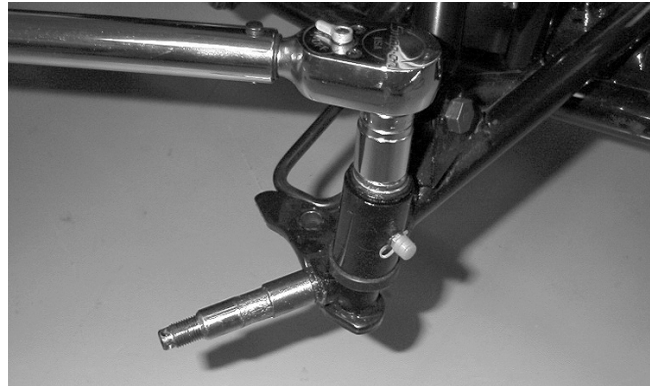

MD2427

4. Install the tie rod end into the steering knuckle and secure it with the self-locking nut. Tighten the nut to specifications; then install a new cotter pin.



MD2426

5. Apply a light coat of grease to spindle shaft; then install the brake backing plate assembly onto the shaft.

■ **NOTE:** When installing the brake backing plate assembly, be sure to align the notch in the backing plate with the tab on the steering knuckle.

7

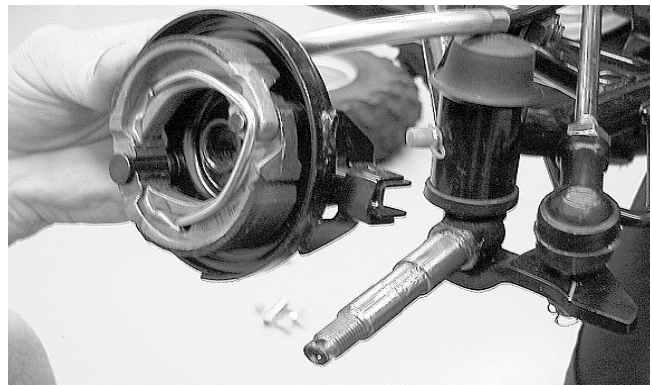

MD2381

6. Place the hub assembly onto the spindle; then install the washer and castle nut. Tighten the castle nut to specifications; then install a new cotter pin. Install the wheel and tighten the cap screws to specifications.



7. Remove the ATV from the support stand.

**⚠ WARNING**

After removing and installing components that are brake-related, ALWAYS check and adjust brakes as necessary before operating the ATV.

## Swing Arm

### REMOVING

1. Secure the ATV on a support stand to elevate the rear wheels; then remove the wheels.

**⚠ WARNING**

Make sure the ATV is solidly supported on the support stand to avoid injury.

2. Remove two cap screws securing the brake caliper to the axle housing.

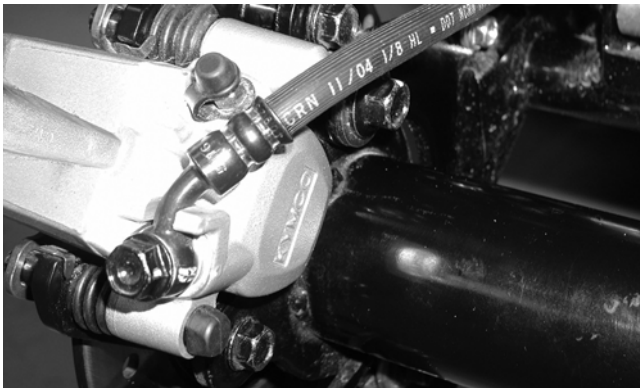

KM207

3. Remove drive chain, hubs, spacers, and axle as necessary (see Rear Hub/Drive Axle in Section 6).

■ **NOTE:** Do not remove more components than necessary to perform the intended service. The axle housing will separate from the swing arm with all components attached if necessary.

4. Remove the four cap screws (A) securing the axle housing to the swing arm; then remove the axle housing.

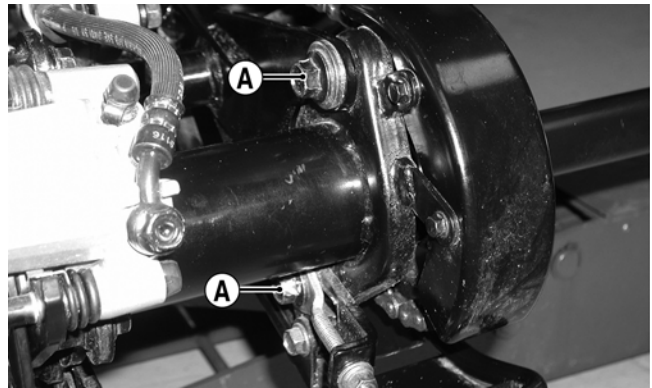

KM217B

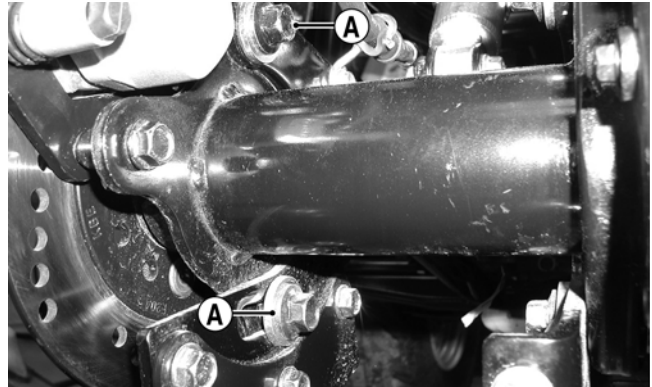

KM212A

5. Remove the cap screws securing the skid plate and rear chain guard; then remove the skid plate and rear chain guard.

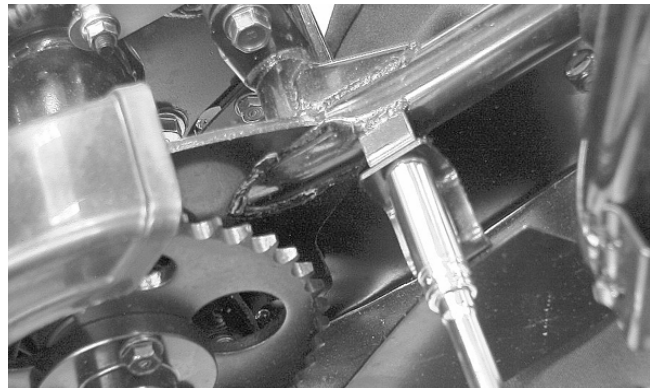

MD2014

6. Remove the cap screw securing the shock absorber to the swing arm.



MD2315

- Remove the long cap screw and self-locking nut securing the front of the swing arm to the frame brackets; then remove the swing arm from the frame. Account for two seals, a spacer, a rubber swing arm guard, and a washer.

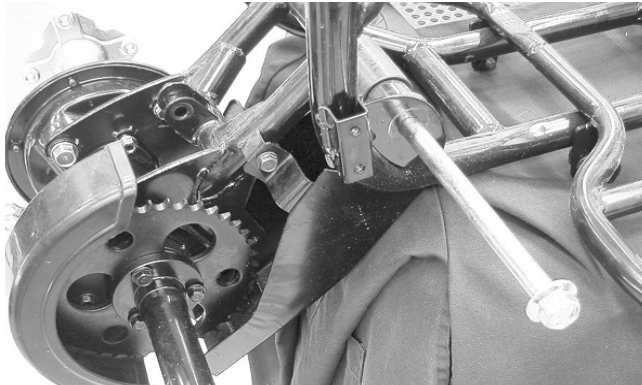

MD2007

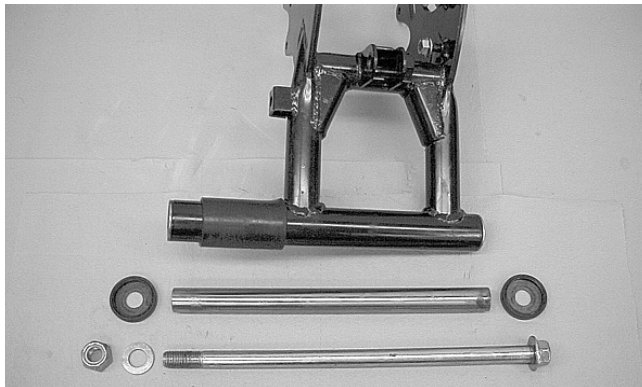

MD2312

## CLEANING AND INSPECTING

■ **NOTE:** Whenever a part is worn excessively, cracked, or damaged in any way, replacement is necessary.

- Clean all swing arm components in parts-cleaning solvent.
- Inspect all swing arm welds for cracks or unusual bends.
- Inspect all tubing for cracks or unusual bends.
- Inspect the pressed-in bushings for damage.
- Inspect the rubber swing arm guard for damage.
- Inspect the seals for damage.

## INSTALLING

- Lubricate the pressed-in swing arm bushings with a light coat of grease; then install the spacer into the swing arm.
- If removed, install the rubber swing arm guard.

- Lubricate the two seals with a light coat of grease; then install them on the ends of the swing arm.
- Position the swing arm in the frame and slide the long cap screw through the brackets and swing arm.

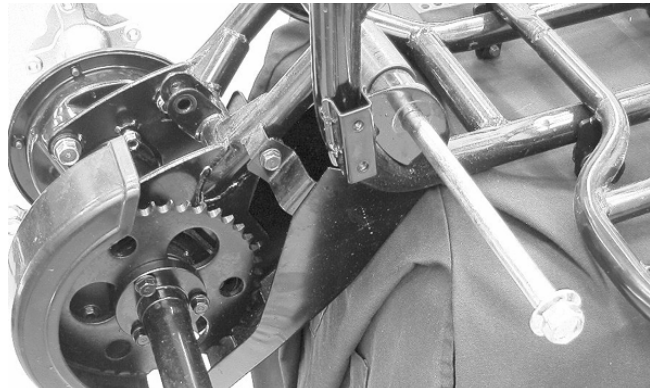

MD2007

- Install the washer and self-locking nut. Tighten the nut to specifications.
- Install the axle, spacers, hubs, and drive chain (see Rear Hub/Drive Axle in Section 6).
- Secure the shock absorber to the swing arm with the cap screw. Tighten the cap screw to specifications.



MD2315

### ⚠ CAUTION

Do not tighten the cap screw beyond the 4.0 kg-m (29 ft-lb) specification or the shock eyelet or mount WILL be damaged.

- Place the rear chain guard and skid plate into position and install the cap screws; then tighten the cap screws securely.

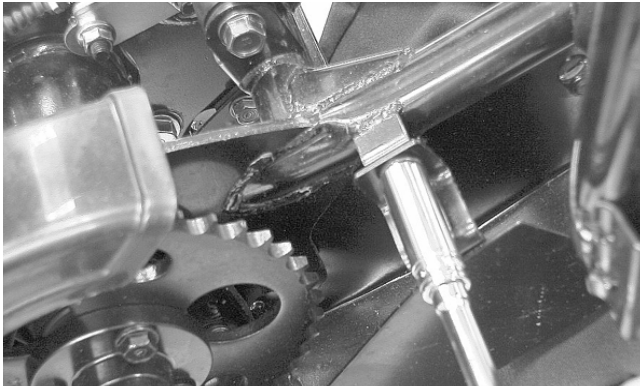

MD2014

9. Place the axle housing into position on the swing arm; then install and tighten four cap screws to specifications.
10. Install the brake caliper on the axle housing with the two cap screws. Tighten securely.



KM229

11. Install the wheels and tighten the cap screws to specifications; then remove the ATV from the support stand.

**⚠ WARNING**

After removing and installing of components that are brake-related, ALWAYS check and adjust brakes as necessary before operating the ATV.

## Wheels and Tires

### TIRE SIZE

**⚠ WARNING**

Use only Arctic Cat approved tires when replacing tires. Failure to do so could result in unstable ATV operation.

The ATV is equipped with low-pressure tubeless tires of the size and type listed (see Section 1). Do not under any circumstances substitute tires of a different type or size.

**⚠ WARNING**

Do not mix tire tread patterns. Use the same pattern type on front and rear. Failure to heed warning could cause poor handling qualities of the ATV and could cause excessive drive train damage not covered by warranty.

### TIRE INFLATION PRESSURE

Front and rear tire inflation pressure should be 0.21 kg-cm<sup>2</sup> (3.0 psi).

**⚠ WARNING**

Always maintain proper tire inflation pressure.

### REMOVING

1. Secure the ATV on a support stand to elevate the wheels.

**⚠ WARNING**

Make sure the ATV is solidly supported on the support stand to avoid injury.

2. Remove the four cap screws securing each wheel; then remove the wheels.

■ **NOTE:** Keep left-side and right-side wheels separated for installing them on their proper sides.



MD2421

## CLEANING AND INSPECTING

■ **NOTE:** Whenever a part is worn excessively, cracked, or damaged in any way, replacement is necessary.

1. Clean the wheels and hubs with parts-cleaning solvent.
2. Clean the tires with soap and water.
3. Inspect each wheel for cracks, dents, or bends.
4. Inspect each tire for cuts, wear, missing lugs, and leaks.

## INSTALLING

1. Install each wheel on its hub.

■ **NOTE:** Make sure each wheel is installed on its proper hub as noted in removing (the “rotation arrow” must indicate forward direction of rotation).

2. Tighten cap screws to specifications.



MD2422

## CHECKING/INFLATING

1. Using an air pressure gauge, measure the air pressure in each tire. Adjust the air pressure as necessary to meet the specified inflation pressure.
2. Inspect the tires for damage, wear, or punctures.

### **WARNING**

**Do not operate the ATV if tire damage exists.**

■ **NOTE:** If repair is needed, follow the instructions found on the tire repair kit or remove the wheel and have it repaired professionally.

■ **NOTE:** Be sure all tires are the specified size and have identical tread pattern.

3. Test drive the ATV on a dry, level surface and note any pulling to the left or right during acceleration, deceleration, and braking.

■ **NOTE:** If pulling is noted, measure the circumference of the front and rear tires on the pulling side. Compare the measurements with the tires on the opposite side. If pulling is noted during braking only, check and adjust the brakes as necessary and recheck operation (see Section 2).

4. Increase the air pressure in the tires with the smallest circumference measurement until all tires are equal in circumference.
5. Repeat steps 3-4 as necessary to ensure proper handling.

# SECTION 8 - STEERING/FRAME

---

---

## TABLE OF CONTENTS

---

Steering/Frame.....	8-2
Steering Post/Handlebar/Tie Rods.....	8-2
Handlebar Grip.....	8-6

---

---

## Steering/Frame

---

■ **NOTE:** Critical torque specifications are located in Section 10.

---

---

## Steering Post/ Handlebar/Tie Rods

---

### REMOVING

1. Remove the seat.



MD2415

2. Remove the control cables from the handlebar; then route them through the metal loop on the steering post and out of the way.

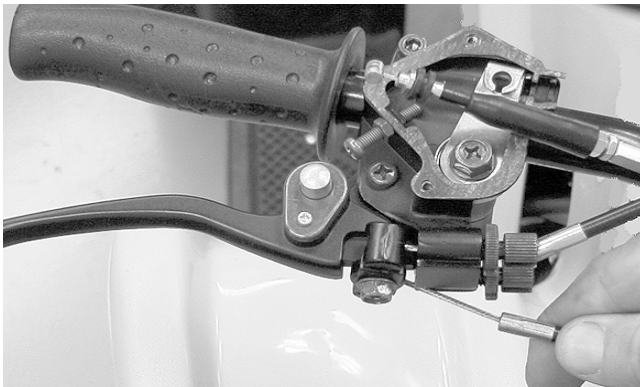

MD2430

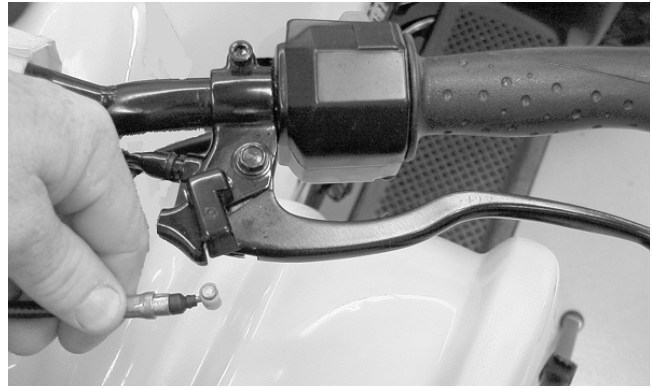

MD2431

3. Remove the handlebar.

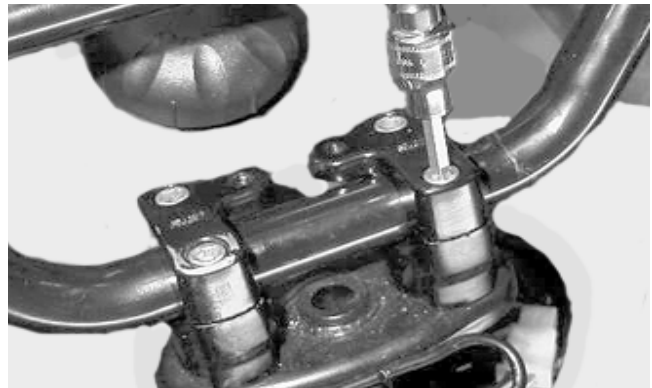

MD2139

4. Disconnect the handlebar switch assembly and brake switch connectors; then route them through the metal loop on the steering post and out of the way.



MD2416

5. Remove the cap screws securing the front fender panel.

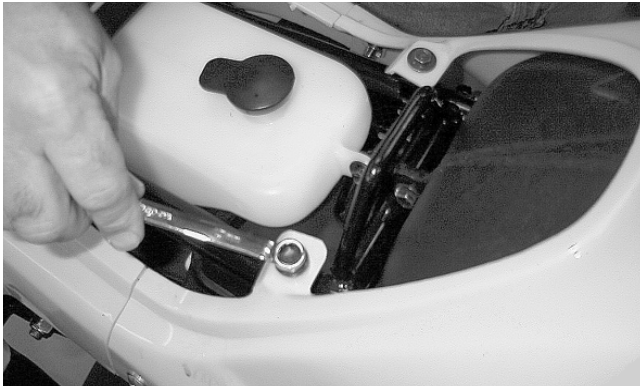

MD2404

6. Remove the gas tank cap and lift off the panel.



MD2405

7. Remove the cotter pins; then remove the two inner tie rod ends from the steering post.

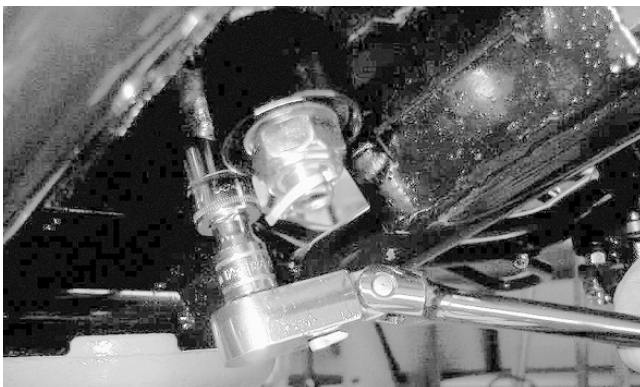

MD2136

8. Remove the cotter pin; then remove the steering post nut.

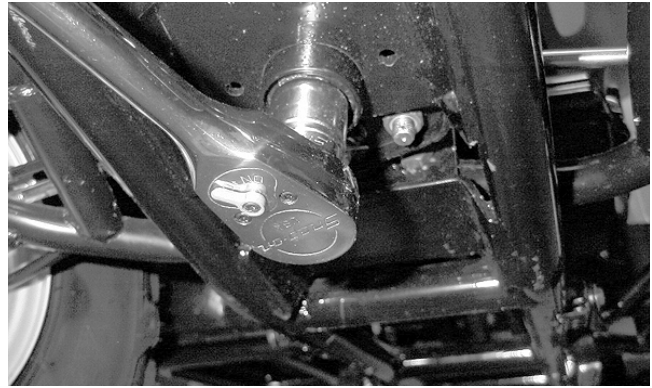

MD2417

9. Remove the steering post outer bearing cap and remove the steering post assembly. Account for the two nuts, the outer bearing cap, and the two-piece plastic bearing.

■ **NOTE:** The inner bearing cap and the two spacers do not need to be removed.

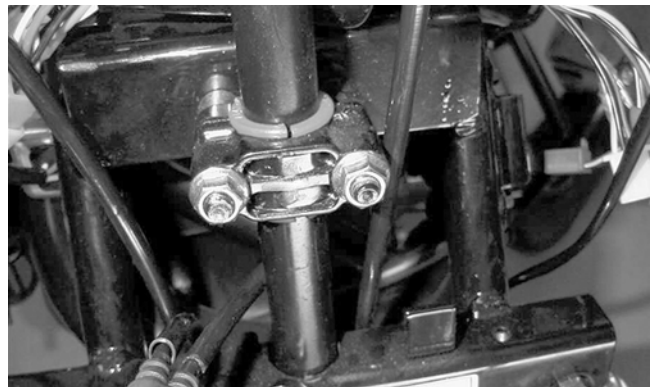

MD2142

## CLEANING AND INSPECTING

■ **NOTE:** Whenever a part is worn excessively, cracked, or damaged in any way, replacement is necessary.

1. Wash the tie rod ends in parts-cleaning solvent. Dry with compressed air. Inspect the pivot area for wear. Apply a low-temperature grease to the ends.

### **WARNING**

Always wear safety glasses when using compressed air.

2. Inspect the tie rods for damaged threads or wear.
3. Inspect the tie rods for cracks or unusual bends.
4. Inspect all welded areas for cracks or deterioration.
5. Inspect the steering post and brackets for cracks, bends, or wear.

6. Inspect the plastic bearing halves and bearing caps for cracks or wear.
7. Inspect the handlebar tube for cracks, wear, or unusual bends.

### INSTALLING

1. Place the steering post into position. Tighten the two nuts on the outer bearing cap making sure the two-piece plastic bearing is in place. Tighten the nuts to specifications.



MD2432

2. Install the steering post nut and tighten to specifications. Install a new cotter pin.

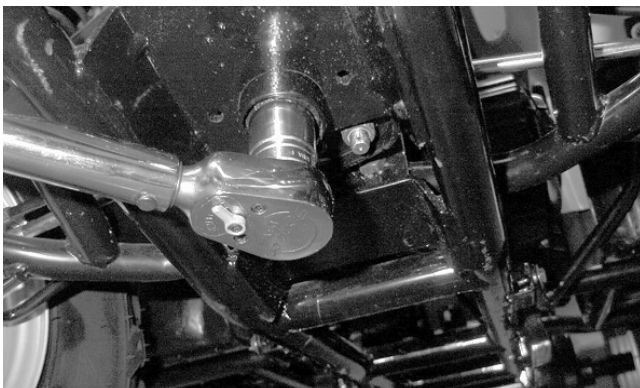

MD2418

3. Install the inner tie rod ends. Tighten the nuts to specifications and install new cotter pins.



MD2419

4. Route the control cables and wiring through the metal loop on the steering post.

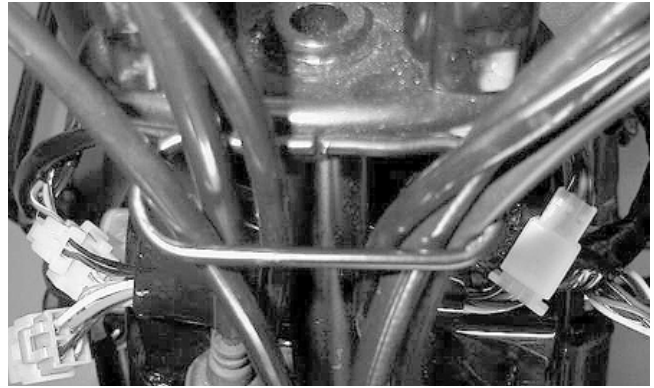

MD2135

5. Install the front fender panel and gas tank cap.



MD2405

6. Install handlebar with alignment pins in lower clamps locating into the holes in the bottom of the handlebar. Install the clamp caps; then tighten the 6 mm Allen-head cap screws to specifications.

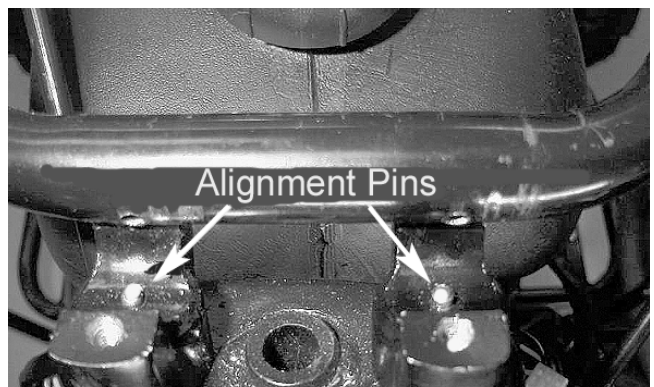

MD2138



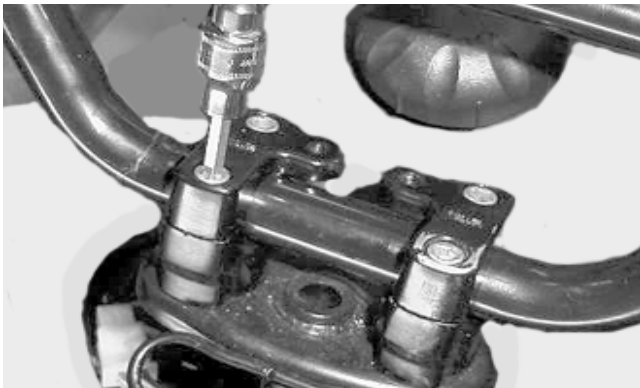

MD2429

7. Install the control cables onto the handlebar.



MD2441

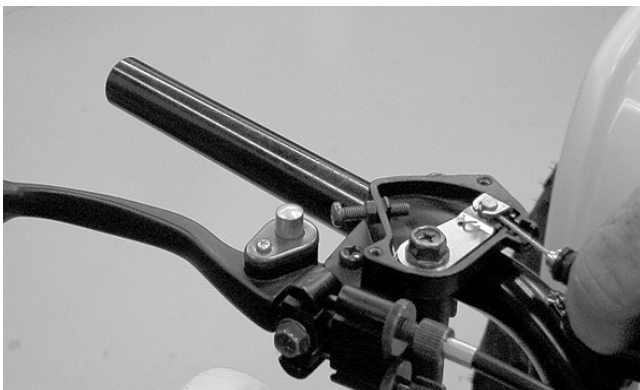

MD2439

8. Make sure the cables (brake and throttle) are routed down and away so there is no sticking or binding.



MD2106

9. Connect the handlebar switch assembly and brake switch connectors.

**⚠ WARNING**  
Make sure that there is maximum right/left steering capability and that the brake and throttle cables are not affected.

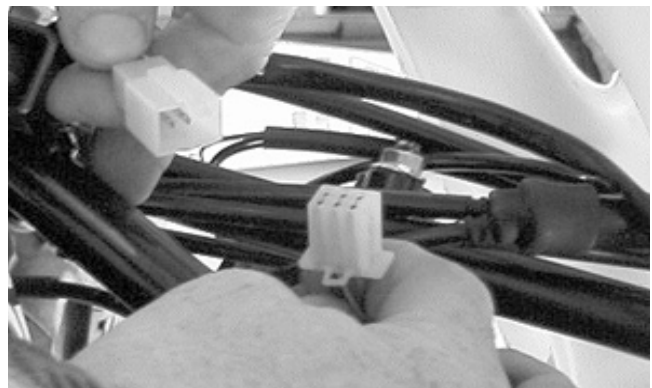

MD2434



MD2105

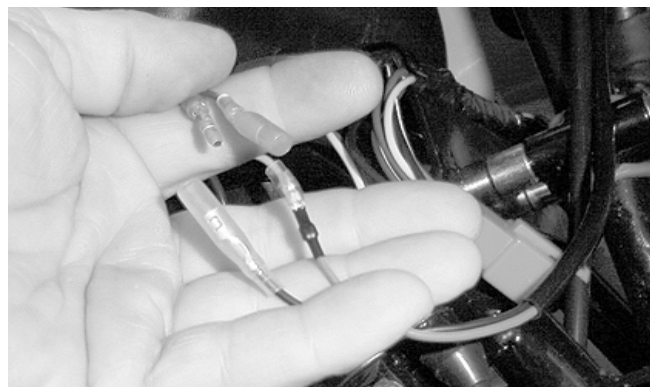

MD2445

10. Install the seat.



MD2415

---

## Handlebar Grip

---

### REMOVING

1. Using a compressed air nozzle and low pressure, peel up the inner corner of the grip.
2. Apply air pressure while twisting the grip back and forth until it slides off the handlebar.

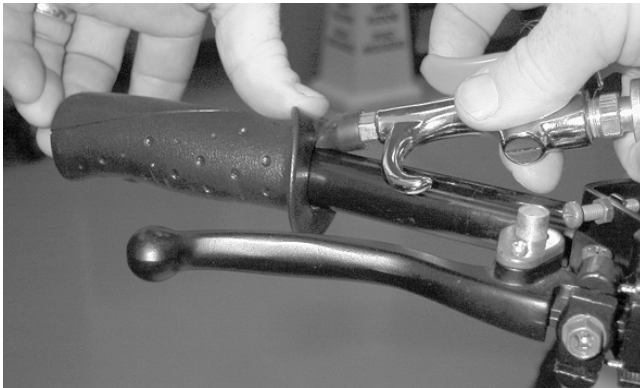

MD2448

### INSPECTING

■ **NOTE:** Whenever a part is worn excessively, cracked, or damaged in any way, replacement is necessary.

1. Inspect the grip for wear, cuts, or cracks.
2. Inspect the grip for deterioration.

### INSTALLING

■ **NOTE:** Before installing a handlebar grip, use contact spray or alcohol to clean the inside of the grip and the handlebar of glue residue, oil, or any other contaminant.

1. Apply a liberal amount of Handlebar Grip Adhesive to the inside of the grip.
2. Slide the grip onto the handlebar until it is fully seated.
3. Wipe off any excess adhesive.

# SECTION 9 - CONTROLS

---

---

## TABLE OF CONTENTS

---

Handlebar Switch .....	9-2
Hand Brake Lever Assemblies .....	9-3

---

---

## Handlebar Switch

---

### REMOVING

1. Disconnect the handlebar switch assembly wiring connector.

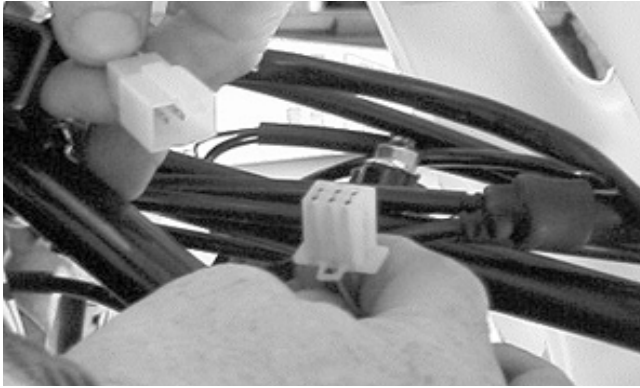

MD2434

2. Disconnect the brake switch wiring connectors.



MD2438

3. Remove the handlebar switch assembly from the handlebar.



KM544



MD2436

### INSTALLING

1. Place the handlebar switch assembly onto the handlebar. Tighten the screw securely.



MD2436



KM544

2. Connect the brake switch wiring connectors.

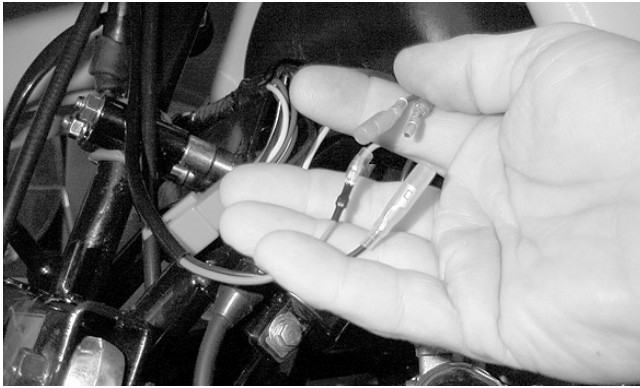

MD2438

3. Connect the handlebar switch assembly wiring connector.

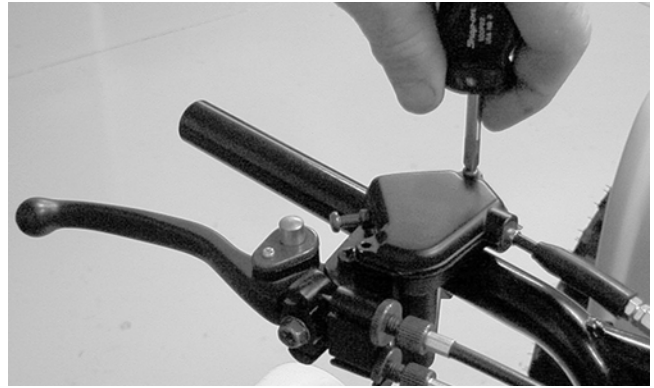

MD2440

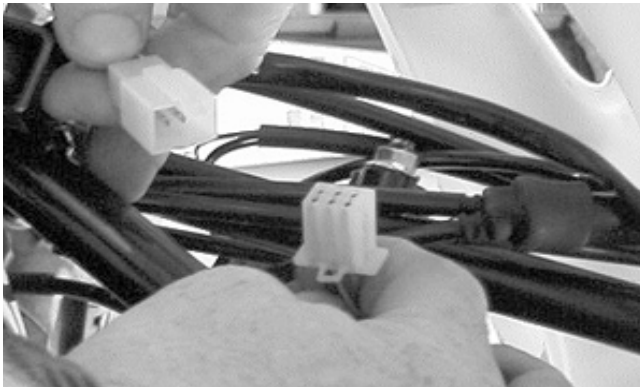

MD2434

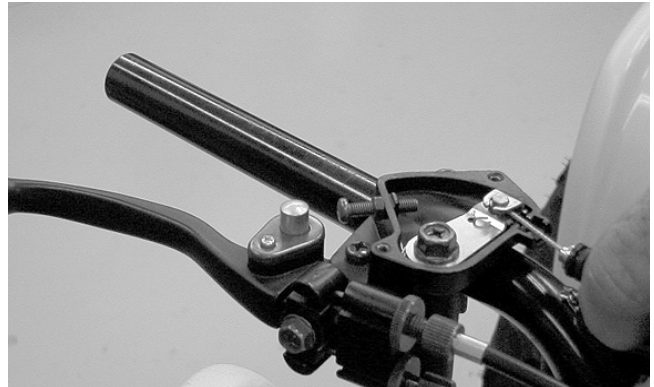

MD2439

3. Remove the front brake cables from their adjusters by screwing the adjusters inward to loosen the cables; then pulling them free.

---

---

## Hand Brake Lever Assemblies

---

### **WARNING**

After removing and installing of components that are brake-related, **ALWAYS** check and adjust brakes as necessary before operating the ATV.

### REMOVING

1. Remove the right handlebar grip (see Section 8).
2. Remove the cover from the throttle control housing exposing the throttle cable; then remove the cable.

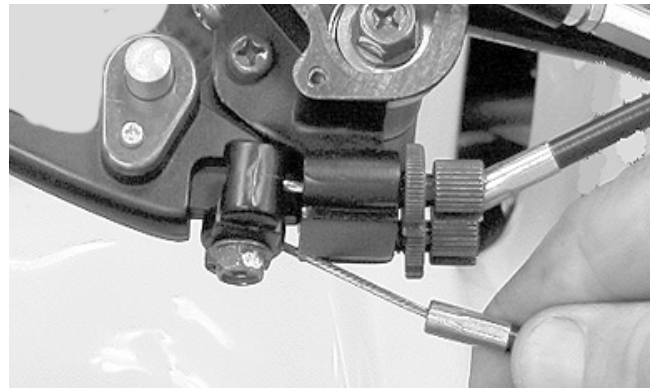

MD2449

4. Loosen the 6 mm Allen-head screw securing the front brake lever assembly and slide the assembly off the handlebar.

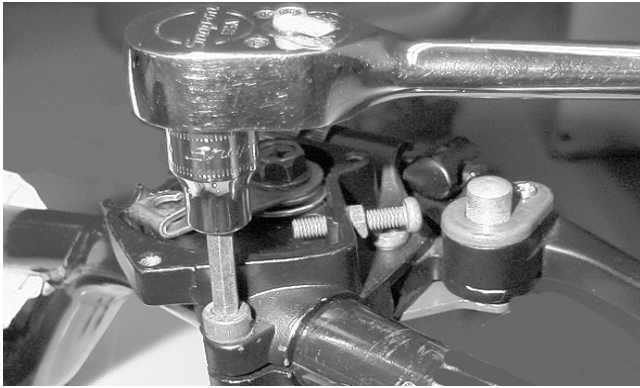

MD2450

5. Place a suitable container beneath the left-hand brake master cylinder.
6. Remove the brakeline hose bolt; then drain brake fluid into the container. Account for two copper washers.

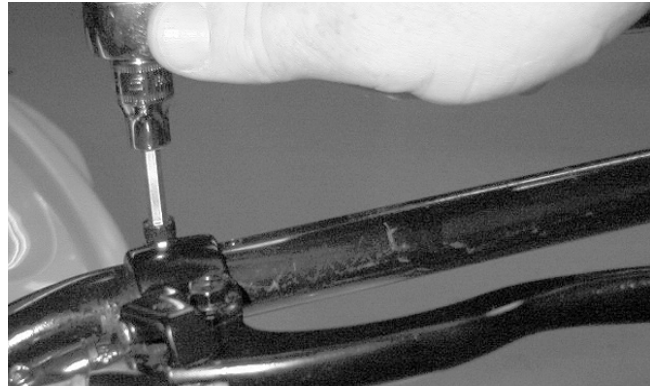

MD2442

## INSTALLING

1. Slide the right brake lever assembly onto the handlebar; do not tighten the Allen-head screw completely at this time.

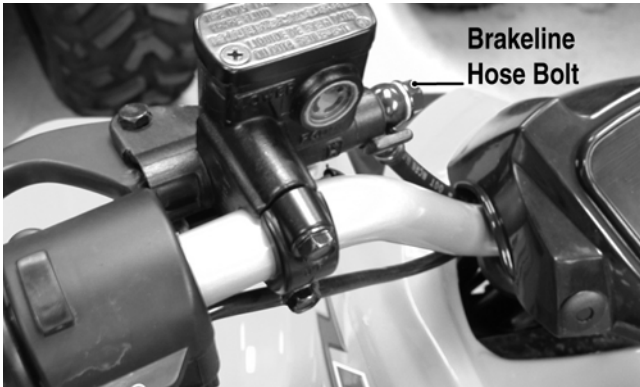

KM208B

7. Remove the cap screws securing the hand brake lever assembly to the handlebar and remove the hand brake/master cylinder assembly.



MD2452

2. Install the throttle cable into the throttle control housing; then install the cover and secure with the screws.

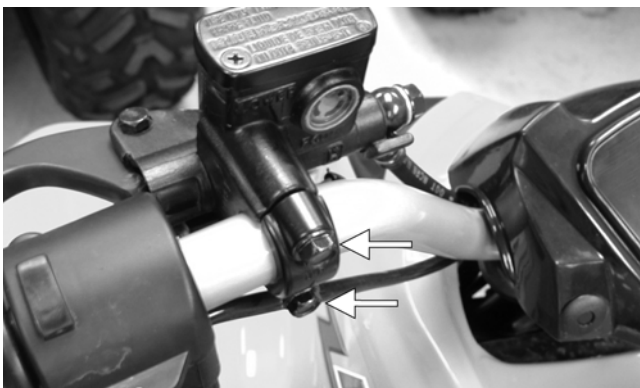

KM208A



MD2454



KM548A

3. Install the brake cable to the lever assembly.

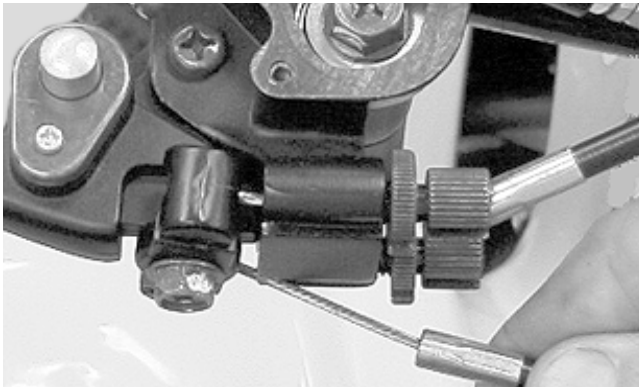

MD2453

4. Position the left brake lever assembly onto the handlebar and secure with the clamp and two cap screws. Tighten securely.

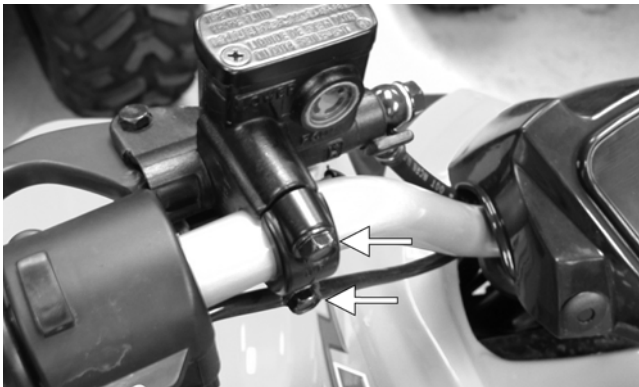

KM208A

5. Install the brakeline hose on the master cylinder with the brakeline hose bolt and two washers. Do not tighten the bolt at this time.

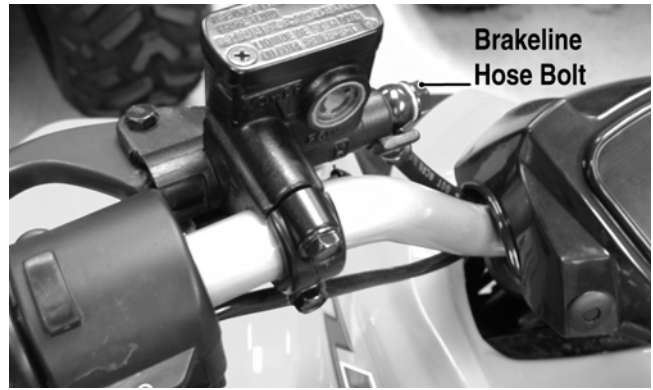

KM208B

6. Remove the cover from the master cylinder and fill with DOT 4 brake fluid; then install the cover.

7. Place a suitable container under the master cylinder and compress the lever slowly. Brake fluid should flow from the loose connection.

8. Tighten the brakeline hose bolt to specifications (see Section 10); then check the rear brake operation. The brake lever should be firm and the rear brake should stop the wheels.

■ **NOTE:** If the brake is not firm, the system must be bled (see Brake Systems - BLEEDING in Section 2).

■ **NOTE:** Before installing a handlebar grip, use contact spray or alcohol to clean the inside of the grip and the handlebar of adhesive residue, oil, or any other contaminant.

9. Apply a liberal amount of Handlebar Grip Adhesive to the inside of the grip; then slide the right grip onto the handlebar. Wipe off any excess adhesive.

10. Tighten the right brake lever assembly Allen-head screw (from step 1) securely.



MD2461

# SECTION 10 - AIDS FOR MAINTENANCE

---

---

## TABLE OF CONTENTS

---

Torque Specifications .....	10-2
Torque Conversions .....	10-3



# Torque Specifications

ENGINE COMPONENTS			
Part	Part Bolted To	Torque kg-m    ft-lb	
Oil Drain Plug	Crankcase	2.0-3.0	14.5-22.0
Spark Plug	Cylinder Head	1.2	9.0
Cylinder Head (Nut)	Cylinder	2.1	15.0
Crankcase Half*	Crankcase Half	1.0	7.0
Flywheel*	Crankshaft	3.5-4.5	25.0-32.5
Stationary Drive Sheave*	Crankshaft	3.8	27.5
Outer Drum*	Driven Pulley/ Centrifugal Clutch	5.5	40.0
Driven Sheave	Driven Pulley/ Centrifugal Clutch	5.5	40.0
Oil Pump Gear	Oil Pump	1.0	7.0
Starter Gear Retainer	Crankcase	1.0	7.0
Starter Motor	Crankcase	1.0	7.0
Cooling Fan	Flywheel	1.0	7.0
Oil Screen/Filter Cap	Crankcase	1.0-2.0	7.0-14.5
Cam Chain Guide	Crankcase	1.0	7.0
Transmission Drain Plug	Transmission	2.1-3.0	15.0-22.0
Cylinder Head (Cap Screw)	Cylinder	1.0	7.0
Tensioner Spring Bolt	Cam Chain Ten- sioner	0.7	5.0
Cylinder Head Cover	Cylinder Head	1.0	7.0
Drive Sprocket	Driveshaft	11.1	80.0
Engine Mount	Engine/Frame	4.5	32.5
Intake Manifold	Cylinder Head	1.0	7.0
Carburetor	Intake Manifold	0.8	6.0
DRIVE TRAIN COMPONENTS			
Rear Hub	Rear Axle Shaft	6.1-8.0	44.0-58.0
Wheel	Front/Rear Hub	4.2	30.0
Centrifugal Clutch Cover	Crankcase	1.0	7.0
Seal Retainer	Crankcase	1.0	7.0
Transmission Case Cover	Transmission	2.8	20.0
Rear Sprocket	Carrier	2.7	19.5
EXHAUST COMPONENTS			
Exhaust Heat Shield	Muffler	1.0	7.0
Exhaust Pipe	Cylinder Head	1.0	7.0
Muffler	Frame	3.5	25.0

ELECTRICAL COMPONENTS			
Part	Part Bolted To	Torque kg-m    ft-lb	
CDI	Frame	1.0	7.0
Voltage Regulator	Frame	0.4	3.0
Stator*	Crankcase	0.8-1.2	6.0-9.0
STEERING COMPONENTS			
Front Hub	Spindle Axle	6.2	45.0
Handlebar Cap	Lower Clamp	1.0	7.0
Steering Post Outer Bearing Cap	Inner Bearing Clamp	2.8	20.0
Steering Post	Frame	3.5	25.0
CHASSIS COMPONENTS			
Air Filter Housing Assembly	Bracket	1.0	7.0
Air Intake Tube	Crankcase	1.2	9.0
Engine (10 mm)	Frame (Front)	4.5	32.5
Engine (8 mm)	Frame (Rear)	2.2	16.0
SUSPENSION COMPONENTS			
Front Shock Absorber	Frame/A-Arm	4.0	29.0
Rear Shock Absorber	Frame/Swing Arm	4.0	29.0
Swing Arm	Frame	6.9	50.0
Swing Arm	Rear Axle Housing	4.0	29.0
A-Arm	Frame	4.0	29.0
Knuckle	A-Arm	4.0	29.0
Tie Rod End	Knuckle	2.8	20.0

\* w/Red Loctite #271

## Torque Conversions

ft-lb	kg-m	ft-lb	kg-m	ft-lb	kg-m	ft-lb	kg-m	ft-lb	kg-m
1	0.1	21	2.9	41	5.7	61	8.4	81	11.2
2	0.3	22	3.0	42	5.8	62	8.6	82	11.3
3	0.4	23	3.2	43	5.8	63	8.7	83	11.5
4	0.6	24	3.3	44	6.1	64	8.9	84	11.6
5	0.7	25	3.5	45	6.2	65	9.0	85	11.8
6	0.8	26	3.6	46	6.4	66	9.1	86	11.9
7	1.0	27	3.7	47	6.5	67	9.3	87	12.0
8	1.1	28	3.9	48	6.6	68	9.4	88	12.2
9	1.2	29	4.0	49	6.8	69	9.5	89	12.3
10	1.4	30	4.2	50	6.9	70	9.7	90	12.5
11	1.5	31	4.3	51	7.1	71	9.8	91	12.6
12	1.7	32	4.4	52	7.2	72	10.0	92	12.8
13	1.8	33	4.6	53	7.3	73	10.1	93	12.9
14	1.9	34	4.7	54	7.5	74	10.2	94	13.0
15	2.1	35	4.8	55	7.6	75	10.4	95	13.1
16	2.2	36	5.0	56	7.7	76	10.5	96	13.3
17	2.4	37	5.1	57	7.9	77	10.7	97	13.4
18	2.5	38	5.3	58	8.0	78	10.8	98	13.6
19	2.6	39	5.4	59	8.2	79	10.9	99	13.7
20	2.8	40	5.5	60	8.3	80	11.1	100	13.8

# SECTION 11- TROUBLESHOOTING

---

---

## TABLE OF CONTENTS

---

**11**

Engine/Transmission .....	11-2
Drive System .....	11-4
Fuel System .....	11-5
Electrical System.....	11-6
Steering/Suspension .....	11-8
Brakes .....	11-9

## Engine/Transmission

<b>Problem: Engine will not start or is hard to start (Compression too low)</b>	
<b>Condition</b>	<b>Remedy</b>
1. <b>Piston rings</b> worn excessively	1. Replace rings
2. <b>Cylinder bore</b> worn	2. Replace - rebore cylinder
3. <b>Spark plug</b> seating poorly	3. Tighten plug
4. <b>Starter motor</b> cranks too slowly - does not turn	4. See Electrical in this section
5. <b>Valves</b> burned - <b>tappets</b> adjusted too tight	5. Replace valves - adjust tappets
<b>Problem: Engine will not start or is hard to start (No spark)</b>	
<b>Condition</b>	<b>Remedy</b>
1. <b>Spark plug</b> fouled	1. Clean - replace plug
2. <b>Spark plug</b> wet	2. Clean - dry plug
3. <b>Magneto</b> defective	3. Replace magneto
4. <b>CDI unit</b> defective	4. Replace CDI unit
5. <b>Ignition coil</b> defective	5. Replace ignition coil
6. <b>High-tension lead</b> open - shorted	6. Replace high tension lead
<b>Problem: Engine will not start or is hard to start (No fuel reaching the carburetor)</b>	
<b>Condition</b>	<b>Remedy</b>
1. <b>Gas tank vent hose</b> obstructed	1. Clean vent hose
2. <b>Carburetor inlet needle</b> defective	2. Replace needle
3. <b>Fuel hose</b> obstructed	3. Clean - replace hose
4. <b>Fuel screens</b> obstructed	4. Clean - replace inlet screen - valve screen
<b>Problem: Engine stalls easily</b>	
<b>Condition</b>	<b>Remedy</b>
1. <b>Spark plug</b> fouled	1. Clean plug
2. <b>Magneto</b> defective	2. Replace magneto
3. <b>CDI unit</b> defective	3. Replace CDI unit
4. <b>Carburetor jets</b> obstructed	4. Clean jets
<b>Problem: Engine noisy (Noise seems to come from piston)</b>	
<b>Condition</b>	<b>Remedy</b>
1. <b>Piston - cylinder</b> worn	1. Replace - service piston - cylinder
2. <b>Combustion chamber</b> carbon buildup	2. Clean chamber
3. <b>Piston pin - piston pin bore</b> worn	3. Replace - service pin - bore
4. <b>Piston rings - ring groove(s)</b> worn	4. Replace rings - piston
<b>Problem: Engine noisy (Noise seems to come from clutch)</b>	
<b>Condition</b>	<b>Remedy</b>
1. <b>Clutch shoe(s)</b> worn	1. Replace clutch shoe(s)
2. <b>Driven clutch hub</b> warped - worn	2. Replace clutch
<b>Problem: Engine noisy (Noise seems to come from crankshaft)</b>	
<b>Condition</b>	<b>Remedy</b>
1. <b>Bearing</b> worn - burned	1. Replace bearing
2. <b>Lower rod-end bearing</b> worn - burned	2. Replace bearing
3. <b>Connecting rod side clearance</b> too large	3. Replace thrust washer(s)
4. <b>Oil level</b> incorrect grade	4. Fill crankcase with recommended engine oil

<b>Problem: Engine idles poorly</b>	
<b>Condition</b>	<b>Remedy</b>
<ol style="list-style-type: none"> <li>1. <b>Magneto</b> defective</li> <li>2. <b>CDI unit</b> defective</li> <li>3. <b>Spark plug</b> fouled - <b>gap</b> too wide</li> <li>4. <b>Ignition coil</b> defective</li> <li>5. <b>Float level</b> out of adjustment</li> <li>6. <b>Carburetor jets</b> obstructed</li> <li>7. <b>Pilot screw setting</b> improper</li> </ol>	<ol style="list-style-type: none"> <li>1. Replace magneto</li> <li>2. Replace CDI unit</li> <li>3. Adjust gap - replace plug</li> <li>4. Replace ignition coil</li> <li>5. Adjust float height</li> <li>6. Clean jets</li> <li>7. Adjust pilot screw</li> </ol>
<b>Problem: Engine runs poorly at high speed</b>	
<b>Condition</b>	<b>Remedy</b>
<ol style="list-style-type: none"> <li>1. <b>Spark plug gap</b> too narrow</li> <li>2. <b>Ignition coil</b> defective</li> <li>3. <b>Float level</b> too low</li> <li>4. <b>Air cleaner element</b> obstructed</li> <li>5. <b>Fuel hose</b> obstructed</li> <li>6. <b>Carburetor jets</b> obstructed</li> <li>7. <b>Air filter inlet pipe</b> obstructed</li> </ol>	<ol style="list-style-type: none"> <li>1. Adjust gap</li> <li>2. Replace ignition coil</li> <li>3. Adjust float arm height</li> <li>4. Clean element</li> <li>5. Clean - prime hose</li> <li>6. Clean jets</li> <li>7. Remove obstruction</li> </ol>
<b>Problem: Exhaust smoke dirty or heavy</b>	
<b>Condition</b>	<b>Remedy</b>
<ol style="list-style-type: none"> <li>1. <b>Piston rings - cylinder</b> worn</li> <li>2. <b>Cylinder wall</b> scored - scuffed</li> <li>3. <b>Crankcase</b> over-full of oil</li> <li>4. <b>Air filter</b> too much air filter element oil</li> <li>5. <b>Carburetor jets</b> incorrect size (too big)</li> </ol>	<ol style="list-style-type: none"> <li>1. Replace - service rings - cylinder</li> <li>2. Replace - service cylinder</li> <li>3. Drain excess oil from crankcase - recheck oil level</li> <li>4. Use recommended type and quantity air filter element oil</li> <li>5. Use recommended carburetor jets</li> </ol>
<b>Problem: Engine lacks power</b>	
<b>Condition</b>	<b>Remedy</b>
<ol style="list-style-type: none"> <li>1. <b>Piston ring(s) - cylinder</b> worn</li> <li>2. <b>Spark plug</b> fouled</li> <li>3. <b>Spark plug gap</b> incorrect</li> <li>4. <b>Carburetor jets</b> obstructed</li> <li>5. <b>Float level</b> out of adjustment</li> <li>6. <b>Air filter element</b> obstructed</li> <li>7. <b>Intake manifold</b> leaking air</li> <li>8. <b>Brake(s)</b> dragging</li> <li>9. <b>Drive axle</b> bent - worn bearings</li> <li>10. <b>Drive chain - sprockets</b> stretched - worn</li> </ol>	<ol style="list-style-type: none"> <li>1. Replace - service rings - cylinder</li> <li>2. Clean - replace plug</li> <li>3. Adjust gap - replace plug</li> <li>4. Clean jets</li> <li>5. Adjust float arm height</li> <li>6. Clean element</li> <li>7. Tighten - replace manifold</li> <li>8. Adjust brake(s)</li> <li>9. Straighten - replace axle</li> <li>10. Replace sprocket - chain</li> </ol>

<b>Problem: Engine overheats</b>	
<b>Condition</b>	<b>Remedy</b>
1. <b>Carbon deposit (piston crown)</b> excessive	1. Clean piston
2. <b>Engine oil</b> low	2. Add engine oil
3. <b>Octane</b> low - <b>gasoline</b> poor	3. Drain - replace gasoline
4. <b>Oil pump</b> defective	4. Replace pump
5. <b>Oil filter/screen</b> obstructed	5. Clean filter/screen
6. <b>Float level</b> low	6. Adjust float arm height
7. <b>Intake manifold</b> leaking air	7. Tighten - replace manifold
8. <b>Air filter element</b> obstructed	8. Clean element

---



---

## Drive System

---

<b>Problem: Power not transmitted from engine to wheels</b>	
<b>Condition</b>	<b>Remedy</b>
1. <b>Drive chain</b> worn - broken	1. Replace chain
2. <b>Countershaft sprocket</b> worn - broken	2. Replace countershaft sprocket
3. <b>Rear sprocket</b> worn - broken	3. Replace rear sprocket
4. <b>Chain</b> slipped off sprockets	4. Replace - adjust drive chain
5. <b>Master link</b> worn - broken - missing	5. Replace master link
<b>Problem: Clutch slipping</b>	
<b>Condition</b>	<b>Remedy</b>
1. <b>Clutch shoes</b> worn - damaged	1. Replace clutch shoes
<b>Problem: Clutch dragging</b>	
<b>Condition</b>	<b>Remedy</b>
1. <b>Clutch return springs</b> weak	1. Replace return springs
2. <b>Clutch</b> worn - damaged	2. Replace clutch

## Fuel System

<b>Problem: Starting impaired</b>	
<b>Condition</b>	<b>Remedy</b>
<ol style="list-style-type: none"> <li>1. <b>Carburetor</b> leaking air</li> <li>2. <b>Choke</b> not operating properly</li> </ol>	<ol style="list-style-type: none"> <li>1. Tighten - adjust carburetor - replace gasket</li> <li>2. Check choke assembly</li> </ol>
<b>Problem: Idling or low speed impaired</b>	
<b>Condition</b>	<b>Remedy</b>
<ol style="list-style-type: none"> <li>1. <b>Slow jet</b> obstructed - loose</li> <li>2. <b>Needle jet</b> obstructed</li> <li>3. <b>Pilot screw setting</b> incorrect</li> <li>4. <b>Float level</b> incorrect</li> </ol>	<ol style="list-style-type: none"> <li>1. Clean - tighten jet</li> <li>2. Clean jet</li> <li>3. Adjust pilot screw</li> <li>4. Adjust float arm height</li> </ol>
<b>Problem: Medium or high speed impaired</b>	
<b>Condition</b>	<b>Remedy</b>
<ol style="list-style-type: none"> <li>1. <b>Main jet</b> obstructed</li> <li>2. <b>Needle jet</b> obstructed</li> <li>3. <b>Throttle valve</b> not operating properly</li> <li>4. <b>Filter</b> obstructed</li> <li>5. <b>Float level</b> incorrect</li> </ol>	<ol style="list-style-type: none"> <li>1. Clean main jet</li> <li>2. Clean needle jet</li> <li>3. Check throttle valve operation</li> <li>4. Clean filter</li> <li>5. Adjust float arm height</li> </ol>
<b>Problem: Overflow and fuel level fluctuations</b>	
<b>Condition</b>	<b>Remedy</b>
<ol style="list-style-type: none"> <li>1. <b>Needle valve</b> worn - damaged - dirty</li> <li>2. <b>Float</b> not working properly</li> <li>3. <b>Float level</b> too high - too low</li> </ol>	<ol style="list-style-type: none"> <li>1. Clean - replace needle valve</li> <li>2. Adjust float arm height - replace float</li> <li>3. Adjust float arm height</li> </ol>

## Electrical System

Problem: Spark absent or weak	
Condition	Remedy
1. <b>Ignition coil</b> defective	1. Replace ignition coil
2. <b>Spark plug</b> defective	2. Replace plug
3. <b>Magneto</b> defective	3. Replace magneto
4. <b>CDI unit</b> defective	4. Replace CDI unit
Problem: Spark plug fouled with carbon	
Condition	Remedy
1. <b>Idle RPM</b> too high	1. Adjust carburetor
2. <b>Gasoline</b> incorrect	2. Change to correct gasoline
3. <b>Air filter element</b> dirty	3. Clean element
4. <b>Spark plug</b> incorrect (too cold)	4. Replace plug with proper heat range
Problem: Spark plug electrodes overheat or burn	
Condition	Remedy
1. <b>Spark plug</b> incorrect (too hot)	1. Replace plug
2. <b>Engine</b> overheats	2. Check cooling fan air intake blockage - damage to fan - cooling shroud
3. <b>Spark plug</b> loose	3. Tighten plug
Problem: Magneto does not charge	
Condition	Remedy
1. <b>Lead wires - connections</b> shorted - loose - open	1. Repair - replace - tighten lead wires
2. <b>Magneto coils</b> shorted - grounded - open	2. Replace magneto coils
3. <b>Regulator/rectifier</b> shorted - punctured	3. Replace regulator/rectifier
Problem: Magneto charges, but charging rate is below the specification	
Condition	Remedy
1. <b>Lead wires</b> shorted - open - loose (at terminals)	1. Repair - tighten lead wires
2. <b>Stator coils (magneto)</b> grounded - open	2. Replace stator coils
3. <b>Regulator/rectifier</b> defective	3. Replace regulator/rectifier
4. <b>Cell plates (battery)</b> defective	4. Replace battery
Problem: Magneto overcharges	
Condition	Remedy
1. <b>Internal battery</b> short circuited	1. Replace battery
2. <b>Regulator/rectifier resistor</b> damaged - defective	2. Replace resistor
3. <b>Regulator/rectifier</b> poorly grounded	3. Clean - tighten ground connection
Problem: Charging unstable	
Condition	Remedy
1. <b>Lead wire</b> intermittently shorting	1. Replace lead wire
2. <b>Magneto</b> internally shorted	2. Replace magneto
3. <b>Regulator/rectifier</b> defective	3. Replace regulator/rectifier



<b>Problem: Starter button not effective</b>	
<b>Condition</b>	<b>Remedy</b>
1. <b>Battery charge</b> low	1. Charge - replace battery
2. <b>Switch contacts</b> defective	2. Replace switch
3. <b>Starter motor brushes</b> not seating	3. Repair - replace brushes
4. <b>Starter relay</b> defective	4. Replace relay
5. <b>Emergency stop - ignition switch</b> off	5. Turn on switches
6. <b>Wiring connections</b> loose - disconnected	6. Connect - tighten - repair connections
<b>Problem: Battery "sulfation" (Acidic white powdery substance or spots on surfaces of cell plates)</b>	
<b>Condition</b>	<b>Remedy</b>
1. <b>Charging rate</b> too low - too high	1. Replace battery
2. <b>Specific gravity</b> too high - too low	2. Charge battery
3. <b>Battery</b> run down - damaged	3. Replace battery
4. <b>Electrolyte</b> contaminated	4. Replace battery
<b>Problem: Battery discharges too rapidly</b>	
<b>Condition</b>	<b>Remedy</b>
1. <b>Electrolyte</b> contaminated	1. Replace battery
2. <b>Specific gravity</b> too high	2. Charge battery
3. <b>Charging system (charging operation)</b> not set properly	3. Check magneto - regulator/rectifier - circuit connections - adjust for specified charging operation
4. <b>Cell plates</b> overcharged - damaged	4. Replace battery - correct charging system
5. <b>Battery</b> short circuited	5. Replace battery
6. <b>Specific gravity</b> too low	6. Charge battery
7. <b>Electrolyte</b> contaminated	7. Replace battery
<b>Problem: Battery polarity reversed</b>	
<b>Condition</b>	<b>Remedy</b>
1. <b>Battery</b> incorrectly connected	1. Reverse connections - replace battery

## Steering/Suspension

<b>Problem: Handling too heavy or stiff</b>	
<b>Condition</b>	<b>Remedy</b>
1. <b>Front wheel alignment</b> incorrect	1. Adjust alignment
2. <b>Lubrication</b> inadequate	2. Lubricate appropriate components
3. <b>Tire inflation pressure</b> incorrect	3. Adjust pressure
4. <b>Tie rod ends</b> seizing	4. Replace tie rod ends
5. <b>Linkage connections</b> seizing	5. Repair - replace connections
<b>Problem: Steering oscillation</b>	
<b>Condition</b>	<b>Remedy</b>
1. <b>Tires</b> inflated unequally	1. Adjust pressure
2. <b>Wheel(s)</b> wobbly	2. Replace wheel(s)
3. <b>Wheel hub cap screw(s)</b> loose - missing	3. Tighten - replace cap screws
4. <b>Wheel hub bearing</b> worn - damaged	4. Replace bearing
5. <b>Tie rod ends</b> worn - loose	5. Replace - tighten tie rod ends
6. <b>Tires</b> defective - incorrect	6. Replace tires
7. <b>A-arm bushings</b> damaged	7. Replace bushings
8. <b>Bolts - nuts (frame)</b> loose	8. Tighten bolts - nuts
<b>Problem: Steering pulling to one side</b>	
<b>Condition</b>	<b>Remedy</b>
1. <b>Tires</b> inflated unequally	1. Adjust pressure
2. <b>Front wheel alignment</b> incorrect	2. Adjust alignment
3. <b>Wheel hub bearings</b> worn - broken	3. Replace bearings
4. <b>Frame</b> distorted	4. Repair - replace frame
5. <b>Shock absorber</b> defective	5. Replace shock absorber
<b>Problem: Steering impaired</b>	
<b>Condition</b>	<b>Remedy</b>
1. <b>Tire pressure</b> too high	1. Adjust pressure
2. <b>Steering linkage connections</b> worn	2. Replace connections
3. <b>Cap screws (suspension system)</b> loose	3. Tighten cap screws
<b>Problem: Tire wear rapid or uneven</b>	
<b>Condition</b>	<b>Remedy</b>
1. <b>Wheel hub bearings</b> worn - loose	1. Replace bearings
2. <b>Front wheel alignment</b> incorrect	2. Adjust alignment
<b>Problem: Steering noise</b>	
<b>Condition</b>	<b>Remedy</b>
1. <b>Caps screws - nuts</b> loose	1. Tighten cap screws - nuts
2. <b>Wheel hub bearings</b> broken - damaged	2. Replace bearings
3. <b>Lubrication</b> inadequate	3. Lubricate appropriate components
<b>Problem: Suspension too soft</b>	
<b>Condition</b>	<b>Remedy</b>
1. <b>Spring(s)</b> weak	1. Replace spring(s)
2. <b>Shock absorber</b> damaged	2. Replace shock absorber

<b>Problem: Suspension too stiff</b>	
<b>Condition</b>	<b>Remedy</b>
1. <b>A-arm bushings</b> worn	1. Replace bushing
2. <b>Shock absorber</b> improperly adjusted (rear)	2. Adjust shock spring preload
<b>Problem: Suspension noisy</b>	
<b>Condition</b>	<b>Remedy</b>
1. <b>Cap screws (suspension system)</b> loose	1. Tighten cap screws
2. <b>A-arm bushings</b> worn	2. Replace bushings
<b>Problem: Rear wheel oscillation</b>	
<b>Condition</b>	<b>Remedy</b>
1. <b>Rear wheel hub bearings</b> worn - loose	1. Replace bearings
2. <b>Tires</b> defective - incorrect	2. Replace tires
3. <b>Wheel rim</b> distorted	3. Replace wheel
4. <b>Wheel hub cap screws</b> loose	4. Tighten cap screws
5. <b>Axle shaft nut</b> loose	5. Tighten nut
6. <b>Rear brake</b> adjusted incorrectly	6. Adjust brake
7. <b>Rear suspension arm-related bushing</b> worn	7. Replace bushing
8. <b>Rear shock absorber</b> damaged	8. Replace shock absorber
9. <b>Rear suspension arm nut</b> loose	9. Tighten nut

---

## Brakes

---

<b>Problem: Braking poor</b>	
<b>Condition</b>	<b>Remedy</b>
1. <b>Brake shoe(s) - pad(s)</b> worn	1. Replace brake shoe(s) - pad(s)
2. <b>Lever free-play</b> excessive	2. Adjust free-play
3. <b>Brake drum(s)</b> worn	3. Replace brake drum(s)
<b>Problem: Brakes drag</b>	
<b>Condition</b>	<b>Remedy</b>
1. <b>Lever free-play</b> less than minimum	1. Adjust free-play
2. <b>Brake shoe return spring(s)</b> loose - sprung	2. Connect - replace return spring(s)