

For Parts Call 606-678-9623 or 606-561-4983



Professional Shop Manual



25cc 2-Cycle P25 Series Engines

NOTE: These materials are for use by trained technicians who are experienced in the service and repair of outdoor power equipment of the kind described in this publication, and are not intended for use by untrained or inexperienced individuals. These materials are intended to provide supplemental information to assist the trained technician. Untrained or inexperienced individuals should seek the assistance of an experienced and trained professional. Read, understand, and follow all instructions and use common sense when working on power equipment. This includes the contents of the product's Operators Manual, supplied with the equipment. No liability can be accepted for any inaccuracies or omission in this publication, although care has been taken to make it as complete and accurate as possible at the time of publication. However, due to the variety of outdoor power equipment and continuing product changes that occur over time, updates will be made to these instructions from time to time. Therefore, it may be necessary to obtain the latest materials before servicing or repairing a product. The company reserves the right to make changes at any time to this publication without prior notice and without incurring an obligation to make such changes to previously published versions. Instructions, photographs and illustrations used in this publication are for reference use only and may not depict actual model and component parts.

© Copyright 2010 MTD Products Inc. All Rights Reserved

www.mymowerparts.com

For Parts Call 606-678-9623 or 606-561-4983

www.mymowerparts.com

Table of Contents

Chapter 1: Introduction 1	
Professional Shop Manual intent	1
Fasteners	1
Assembly	2
Description	2
Identifying engines	3
Model and Serial Numbers	4
Chapter 2: Maintenance 5	
Maintenance	5
Air filter	5
Spark plugs	6
Spark arrestor	7
Fuel filter	8
Storage	9
Chapter 3: Troubleshooting 11	
Definitions	11
Introduction	11
Steps to troubleshooting	11
Identify factors that could cause the problem	13
Repairing the problem	16
Diagnostic tests	16
Prime test	17
Compression testing	18
Chapter 4: Ignition 19	
Troubleshooting the Ignition System	19
Testing the module	20
Test the engine stop switch	21
Module	22
Flywheel	23

Chapter 5: Fuel system and carburetor 25

Fuel system troubleshooting	25
Inspecting the fuel	25
Check the fuel/oil mixture	26
To check the fuel in the carburetor:	26
Test fuel for alcohol	27
Fuel filter	28
Fuel lines	29
Fuel tank vent	29
Fuel tank	30
Carburetor	31
Troubleshooting the carburetor	31
Disassembly of the carburetor	33
Re-assembly of the carburetor	37
Carburetor insulator	39

Chapter 6: Starters 41

Recoil Starter Removal	41
The starter rope, pulley and springs	43

Chapter 7: Clutch and Upper Drive Shaft 47

Drive shaft assembly	47
Clutch removal/replacement	49

Chapter 8: Engine assembly 51

Theory of operation	51
Engine disassembly	52
Engine Reassembly	55

CHAPTER 1: INTRODUCTION

Professional Shop Manual intent

This Manual is intended to provide service dealers with an introduction to the mechanical aspects of the 25cc P25 series of 2-cycle engines.

Disclaimer: The information contained in this manual is correct at the time of writing. Both the product and the information about the product are subject to change without notice.

About the text format:

NOTE: is used to point out information that is relevant to the procedure, but does not fit as a step in the procedure.

- Bullet points: indicate sub-steps or points.



Caution is used to point out potential danger to the technician, operator, bystanders, or surrounding property.



Warning indicates a potentially hazardous situation that, if not avoided, could result in death or serious injury.



Danger indicates an imminently hazardous situation that, if not avoided, will result in death or serious injury. This signal word is to be limited to the most extreme situations

Disclaimer: This manual is intended for use by trained, professional technicians.

- Common sense in operation and safety is assumed.
- In no event shall MTD be liable for poor text interpretation or poor execution of the procedures described in the text.
- If the person using this manual is uncomfortable with any procedures they encounter, they should seek the help of a qualified technician or MTD Technical Support.

Fasteners

- Most of the fasteners used on the engine are metric. Some are sized in fractional inches. For this reason, wrench sizes are frequently identified in the text, and measurements are given in U.S. and metric scales.
- If a fastener has a locking feature that has worn, replace the fastener or apply a small amount of releasable thread locking compound such as Loctite® 242 (blue).
- Some fasteners like cotter pins are single-use items that are not to be reused. Other fasteners such as lock washers, retaining rings, and internal cotter pins (hairpin clips) may be reused if they do not show signs of wear or damage. This manual leaves that decision to the judgement of the technician.

P25 Series of engines

Assembly

Torque specifications may be noted in the text that covers assembly, they may also be summarized in tables along with special instructions regarding locking or lubrication. Whichever method is more appropriate will be used. In many cases, both will be used so that the manual is handy as a quick-reference guide as well as a step-by-step procedure guide that does not require the user to hunt for information.

The level of assembly instructions provided will be determined by the complexity and of reassembly, and by the potential for unsafe conditions to arise from mistakes made in assembly.

Some instructions may refer to other parts of the manual for subsidiary procedures. This avoids repeating the same procedure two or three times in the manual.

Description

The P25 series of engines are used on a variety of string trimmers. These engines have:

- 25cc's of displacement.
- Piston ported/loop scavenged design.
- Cantilever crankshaft.



Figure 1.1

Identifying engines

MTD currently has two cantilever crank, 2-cycle engines: the A31 and the P25.

NOTE: The starter is mounted between the engine and the drive shaft on all cantilever engines.

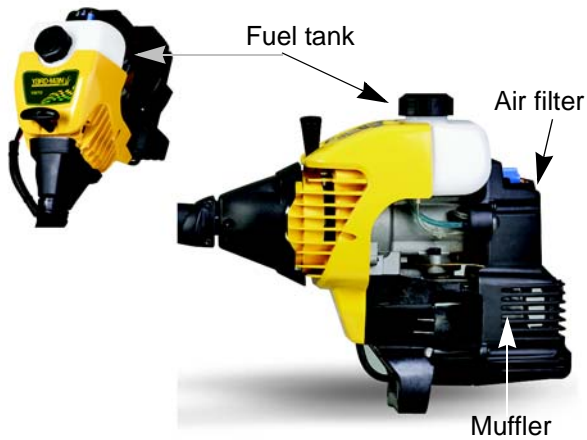

Figure 1.2

A31

- 31 cc's of displacement.
- Muffler on back side of engine.
- Fuel cap on top of engine.
- Air filter on rear of engine.
- Reed valve/loop scavenged design.



Figure 1.3

P25

- 25cc's of displacement.
- Muffler on side of engine.
- fuel tank on bottom of engine.
- Air filter on side of engine.

P25 Series of engines

Model and Serial Numbers

The model (item) and serial number are on a little white sticker with bar code. These are the numbers needed when ordering parts. This sticker can be found on the side of the engine.

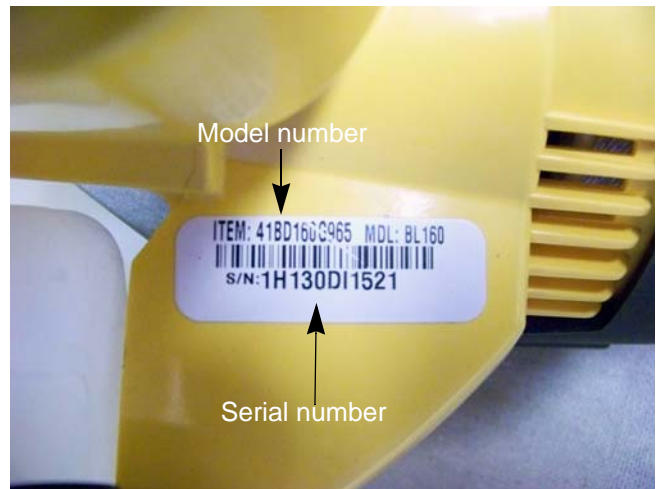

Figure 1.4

The model number is 41BD160G965. The break down of what the number mean is as follows:

41 Hand held product
.....B..... Sales level
..... D..... Product type
.....160 Unique Identifier
.....G..... Packaging code
.....965 Customer number

The serial number is 1H130DI1521. The serial number reads as follows:

1 Engineering level
...H..... Month of production (H = August)
.....13 Day of the month
.....0 Last digit of the year
.....D..... Plant it was built in (MTD Southwest)
.....I Assembly line number
.....1521 Number of unit built

CHAPTER 2: MAINTENANCE

MAINTENANCE

The information in this manual applies to the P25 series of engines. Some basic principles may apply to other engines produced by MTD and other manufacturers.

As the saying goes “an ounce of prevention is worth a pound of cure”. The same can be said about preventive maintenance on outdoor power equipment. By changing the spark plug and air filter at recommended intervals many failures can be avoided. Sometimes just clearing off yard debris that has collected through use can make the difference between a properly running piece of equipment and the expensive inconvenience of unplanned repairs.

Air filter

A dirty air filter can reduce engine power, increase fuel consumption, increase CO emissions and make starting more difficult.

The air filter should be cleaned every 10 hours of use (depending on area of use, dusty areas require more frequent cleanings).

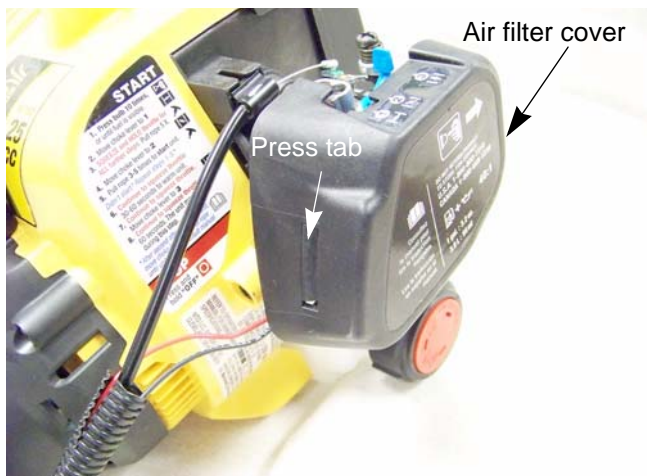

Figure 2.1

To clean/replace the air filter:

1. Remove the air filter cover by pressing in the tab on the front side of the filter housing and swinging the cover towards the rear of the engine. See Figure 2.1.

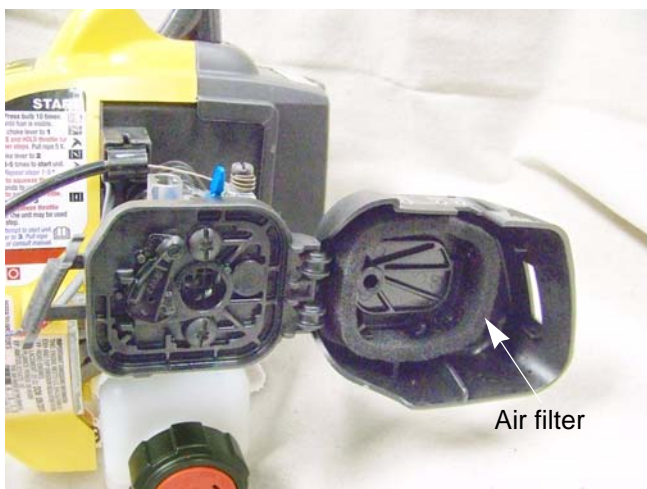

Figure 2.2

2. Pull the filter out. See Figure 2.2.
3. If the filter is crumbling or brittle, replace the filter.
4. Wash the air filter with warm soapy water. Let the filter air dry. **DO NOT** wring the filter out.

NOTE: Wringing the filter can tear it. Squeeze the filter, but do not twist it.

5. Put a drop of oil to the filter and squeeze it through out the filter.
6. Insert the filter into air filter housing.
7. Install the air filter cover.
8. Test run the engine before returning it to service

P25 Series of engines

Spark plugs

The spark plug used in the 25cc trimmer is a Champion RDJ7J (794-00055) gapped to 0.025" (0.655 mm). See Figure 2.3.

Wear rate will vary with severity of use. If the edges of the center electrode are rounded-off, or any other apparent wear / damage occurs, replace the spark plug before operating failure (no start) occurs.

Cleaning the spark plug:

NOTE: MTD does not recommend cleaning spark plugs.

- Use of a wire brush may leave metal deposits on the insulator that causes the spark plug to short out and fail to spark.
- Use of abrasive blast for cleaning may cause damage to ceramic insulator or leave blast media in the recesses of the spark plug. When the media comes loose during engine operation, severe and non-warrantable engine damage may result.

Inspection of the spark plug can provide indications of the operating condition of the engine.

- Light tan colored deposits on insulator and electrodes is normal.
- Dry, black deposits on the insulator and electrodes indicate an over-rich fuel / air mixture (too much fuel or not enough air)
- Wet, black deposits on the insulator and electrodes indicate the presence of oil in the combustion chamber.
- Heat damaged (melted electrodes / cracked insulator / metal transfer deposits) may indicate detonation.
- A spark plug that is wet with fuel indicates that fuel is present in the combustion chamber, but it is not being ignited.

Spark plug removal and installation

To replace a spark plug:

1. Disconnect the spark plug wire.



Do not grab the spark plug wire with pliers. Damage to the sparkplug boot will result. A damaged spark plug boot will weaken the spark of the spark plug.

2. Push the Spark plug wire boot into the starter housing. See Figure 2.4.
3. Remove the spark plug using a 5/8" spark plug socket.
4. Gap a new plug at 0.025" (0.6 mm).
5. Install the spark plug and tighten to a torque of 160 - 220 in. lbs. (18 -25 Nm).
6. Re-connect the spark plug wire.
7. Test run the trimmer in a safe area before returning it to service.

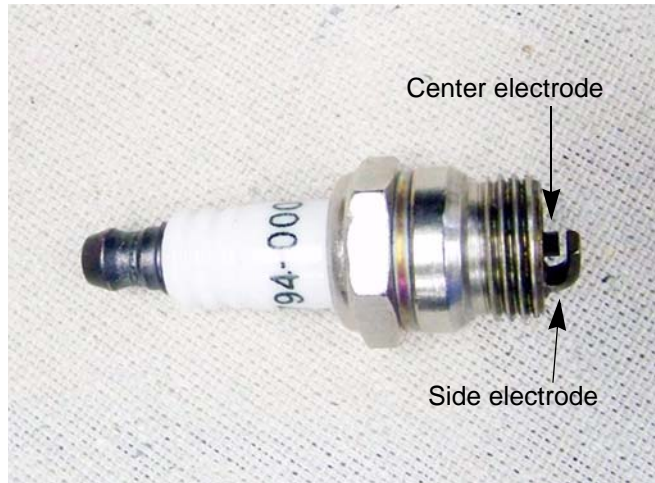

Figure 2.3

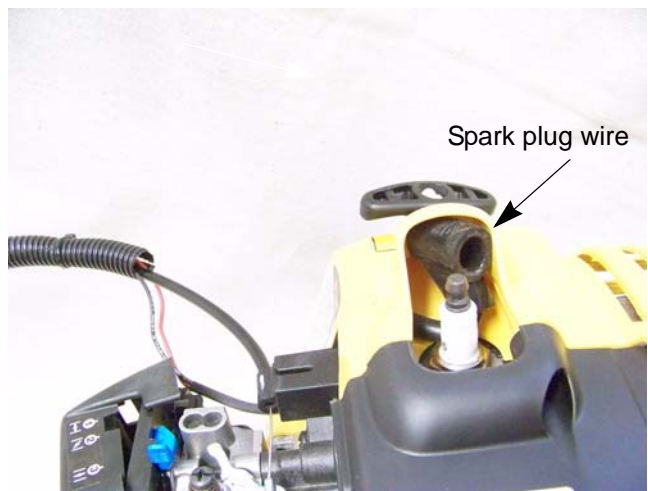

Figure 2.4

Spark arrestor



Figure 2.5

A spark arrestor is a screen that is in the outlet of the muffler. It's job is to collect any sparks or hot embers that are exiting the muffler. The spark arrestor will develop a carbon build up over time. This build up will restrict the exhaust flow, affecting engine performance.

The spark arrestor is part of the muffler and is not accessible for cleaning. It should be inspected every 25 hours of use. When it develops a carbon build up, replace the muffler.

NOTE: The spark arrestor also serves to keep blockages out of the exhaust system. Typical blockages include insect nests built during the dormant season.



Do not return an engine to service without a working spark arrestor. Use of the engine or equipment on unimproved land can start a fire if the spark arrestor has been removed.

P25 Series of engines

Fuel filter

A dirty fuel filter can result in a lean run condition. The fuel filter should be inspected every 25 hours of use.

NOTE: The weighted fuel filter (clunk) keeps the filter submerged in the fuel at any angle of operation. The filter removes dirt and air bubbles from the fuel. Running the trimmer without the filter may allow air into the fuel line creating a lean run condition at higher RPMs. This will cause a catastrophic failure of the engine.

NOTE: Starting in 2012, EPA guidelines will mandate that all handheld engines produced have low permeation fuel lines. These fuel lines do not stand up to the removal/installation methods used in the field. Because of this, the fuel filter and fuel lines are serviced with the fuel tank.

To inspect the fuel filter:

1. Bend a piece of wire to make a hook.
See Figure 2.6.
2. Remove the gas cap.

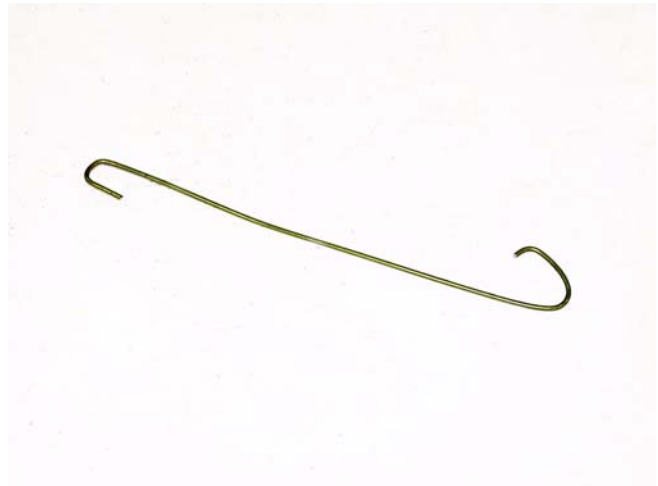

Figure 2.6

3. Stick the hook end of the wire into the fuel tank and fish out the fuel filter. See Figure 2.7.
4. Inspect the filter for signs of dirt or damage.
NOTE: If the filter is dirty or damaged, the whole fuel tank assembly must be replaced.
5. Place the filter back inside the fuel tank.
NOTE: Pay close attention to the fuel line. If they are discolored or brittle, replace the fuel tank assembly.
6. Test run the engine before returning it to service.

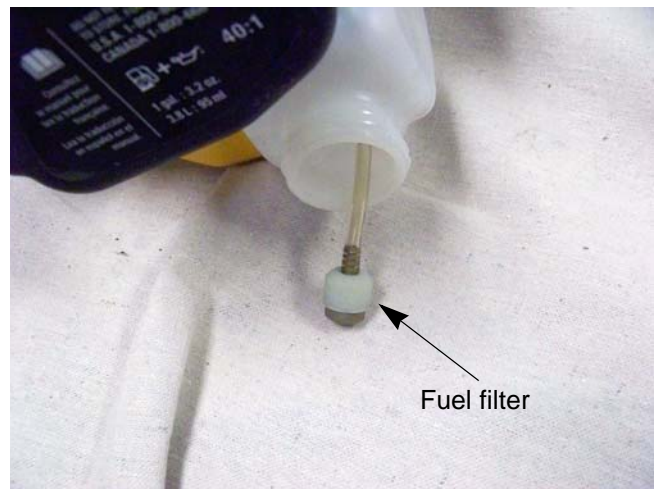

Figure 2.7

Storage

When storing a piece of gas powered equipment for longer than 4 weeks, the following procedures will prolong the engine life and minimize issues such as hard starting after storage.

1. Run the engine until it is out of gas.
2. Open the air filter cover.
3. Spray some oil down the throat of the carburetor.
4. Close the air filter cover.
5. Pull the starter rope to turn the engine over a few times.

Returning to service:

- When returning to service, fill the fuel tank with fresh fuel/oil mix.
- The engine should start normally.

For Parts Call 606-678-9623 or 606-561-4983

P25 Series of engines

CHAPTER 3: TROUBLESHOOTING

Definitions

Troubleshooting - The act of gathering information by performing tests and direct observations.

Diagnosis - A theory of what the problem is, based on the information gathered by troubleshooting.

Introduction

Diagnosing an engine is an art form that is built on several factors. First and most importantly is a good understanding of how the engine works. The second is a skill set that has been honed by experience. Finally the use of visual observations and a structured, systematic approach to troubleshooting a problem.

The first part of this chapter will outline the steps of troubleshooting an engine so a technician can form a proper diagnosis. The second half of this chapter will describe specific procedures and tests to perform while troubleshooting.



The first two rules in troubleshooting are to cause no further harm to the engine and to prevent injuries. Always check for the proper fuel/oil mix before starting an engine. Check attachments for damage and make sure they are firmly mounted.

Steps to troubleshooting

NOTE: The steps and the order of the steps that follow are a suggested approach to troubleshooting the trimmer engine. The technician does not necessarily have to follow them as described in this chapter

Define the problem

The first step in troubleshooting is to define the problem:

1. Crankshaft will not turn.
 - Hard to pull rope, steady pressure
 - Rope jerks back
 - Rope will not pull at all
2. Crankshaft turns, no start
3. Starts, runs poorly
 - Starts, then dies
 - Runs with low power out put
 - Makes unusual smoke when running
 - I. Black smoke, usually heavy
 - II. White smoke, usually heavy
 - III. Blue smoke. usually light
 - Makes unusual sounds when running
 - I. Knock
 - II. Click
 - III. Chirp
 - IV. Unusual exhaust tone

P25 Series of Engines

There are tools that the technician can use in order to define the problem, such as:

1. Interview the customer.
 - Get a good description of their complaint.
 - If it is an intermittent problem, verify what conditions aggravates the problem as best as possible.
 - Get an accurate service history of the equipment.
 - Find out how the customer uses and stores the equipment.
 2. Direct observation:
 - Do not take it that the customer is correct with their description of the problem. Try to duplicate the problem.
 - Check the general condition of the equipment (visually).
 - I. Cleanliness of the equipment will indicate the level of care the equipment has received.
 - II. Make sure the engine and attachments are securely fastened.
 - III. The tune-up factors.
- NOTE:** Most hard starting and poor running conditions can be solved by performing a tune-up.
- a. Check the level and condition of the fuel.
 - b. Check the air filter and look for signs of dirt ingestion.
 - c. Check the ignition and “read” the spark plug.
 - d. Look for obvious signs of physical damage, bent blade, exhaust system blockage or cooling system blockage.
5. Broken starter rope.
 - Usually means the engine was hard to start.
 - Makes it impossible to confirm any running or hard starting symptoms by direct observation.
 - Some inference can be made from checking other factors of the general condition of the equipment.

Identify factors that could cause the problem

This is the second step in the troubleshooting process.

1. Crankshaft will not turn.
 - Hard to pull rope, steady pressure - This usually indicates a mechanical bind of some sort. the likely suspects are:
 - II. A parasitic load from a jammed attachment or drive shaft.
 - III. An internal drag from a scored or seized piston.
 - Rope jerks back - This usually indicates that the piston is stopping before top dead center on the compression stroke and is being driven back down by compression or combustion. The likely suspects are:
 - I. Compression that is unusually high.
 - a. a partial hydraulic lock.
 - II. Ignition timing is advanced.
 - a. Improper air gap.
 - b. Sheared or missing flywheel key.
 - c. The wrong flywheel or module is installed on the engine.
 - Rope will not pull at all -This is usually either a quick fix or a catastrophic failure. The likely suspects are:
 - I. A broken starter recoil (easy fix).
 - II. Complete hydraulic lock (easy fix).
 - III. External binding/jammed attachment (easy fix).
 - IV. Internal binding, crankshaft, connecting rod or piston (unrepairable)

5. Crankshaft turns, no start.
 - Most gasoline engine diagnosis involves isolating problems in the four critical factors an engine needs to run properly:
 - I. Ignition- sufficient spark to start combustion in the cylinder, occurring at the proper time.
 - II. Compression- enough pressure in the cylinder to convert combustion into kinetic motion. It also needs sufficient sealing to generate the vacuum needed to draw in and atomize the next intake charge.
 - III. Fuel- correct type and grade of fresh gasoline; in sufficient quantity, atomized (tiny droplets) and in correct fuel/air proportions.
 - IV. Flow- if all of the above conditions are met, but the flow of air is constricted on the inlet or exhaust side it will cause the engine to run poorly or not at all. This also includes ensuring the valves are timed to open at the proper time.
 - Isolate the ignition system and compression from the fuel system by performing a prime test.
 - I. Burns prime and dies. This would indicate a fuel system issue.
 - II. Does not burn prime. Not a fuel system issue. Check for an ignition, compression or flow problem.
 - Compression or ignition problem
 - I. Check the engine stop and/or ignition switch.
 - II. Test the ignition system using a proper tester.
 - III. Replace the spark plug with a new one or a known good one.
 - IV. Check compression.
 - V. Check exhaust.

P25 Series of Engines

6. Starts, runs poorly
 - Starts, then dies
 - I. Run the engine with a spark tester in-line between the spark plug wire and the spark plug or use an oscilloscope and see if the spark goes away at the same time the engine dies.
 - II. Check choke operation.
 - a. Black smoke?
 - b. Wet plug?
 - III. Test for invisible damage to the air filter by starting the engine with the air filter removed.
 - IV. Prime test immediately after engine dies. If it restarts; this may indicate a problem with fuel flow to the carburetor. Check the gas cap, fuel line, fuel filter, and the carburetor.
 - Runs with low power output.
 - I. Look for unusual exhaust color (smoke).
 - II. Unusually hot muffler (may glow red).
 - a. Retarded ignition
 - III. Mechanical bind
 - a. A loose ignition module can drag on the flywheel or lock it up.
 - b. Parasitic external load. A bind in the equipment the engine is powering.
 - c. Internal drag from a scored piston or similar damage.
 - IV. Low compression/case leak
 - a. Check compression
 - Engine hard to start.
 - May start and run if prime test is used.
 - May run well at high RPMs, but will not idle.
 - “Sluggish” pick-up from lower RPMs.
 - II. Flow blockage
 - a. Exhaust blockage may idle, but performs poorly. It usually is accompanied by an unusual exhaust sound.
- NOTE:** Just as a throttle on the carburetor controls the engine RPMs by limiting the amount of air an engine can breathe in, an exhaust blockage will limit engine performance by constricting the other end of the system.
- II. The muffler itself may be blocked.
 - III. The spark arrestor may be blocked.
 - IV. Intake blockage
 - a. An intake blockage up-stream of the carburetor will cause a rich fuel/air mixture and constrict the amount of air that the engine can draw in, limiting performance. A blocked air filter is a common cause of this.
 - VII. Makes unusual smoke when running
 - a. Black smoke, usually heavy usually indicates a rich air fuel mixture
 - Not enough air: air filter blockage or a partially closed choke.

- Too much fuel: needle valve stuck or metering / emulsion issues with the carburetor.
 - b. Blue smoke, usually light.
 - Too much oil in the fuel mix.
- IX. Piston rings
- a. Confirm with compression test.
 - b. Repair may not make economic sense.
- X. Makes unusual noise when running.
- Knock
 - * Check for loose mounting of engine or driven implement
 - * Rotate crankshaft back-and-forth to check for loose connecting rod.
 - Click
 - * Half-engine speed clatter, slightly heavier: wrist-pin.
 - * Rhythmic heavy-light engine speed click: piston slap
 - Spark-knock
 - * Advanced ignition timing
 - * Low octane fuel
 - * Over-heating engine (check for blocked cooling air flow)
 - * Carbon build-up in cylinder: glowing carbon chunks pre-igniting air fuel mix.
- XI. Unusual exhaust tone
- a. Splashy, blatty, wheezing or whistling.
 - Splashy or blatty idle usually indicates a slightly rich condition.
 - Whistling or wheezing may indicate an exhaust blockage, usually slightly muffled.
 - Backfire
 - * On over-run: unburned fuel igniting past exhaust port. Mixture not burning completely in combustion chamber. It may be too rich or it may be a spark plug or an ignition problem.
 - Skip
 - * Usually ignition related.
- NOTE:** If the engine is run with no load at maximum RPMs, the rev limiter may be triggered causing the engine to skip at 7,900 RPM. This is a normal function of the rev limiter.
- * Run the engine with a spark tester in-line between the spark plug wire and the spark plug or use an oscilloscope and see if the spark goes away at the same time the engine dies.
- XII. Engine RPMs surge (hunting)
- a. The Ideal stoichiometric ratio/AFR (Air Fuel Ratio) for this engine is (12.5:1 - 13:1). An engine that runs with an AFR greater than 13:1 is running lean. The engine RPMs will sink until they reach a point that can be supported by the available fuel. This causes a momentary surge in power until the available fuel is consumed, then the RPMs fall again, repeating the cycle.
 - Too much air: look for an air leak in the intake tract
 - Not enough fuel: look for fuel supply or carburetor problems

P25 Series of Engines

Repairing the problem

The third step in the diagnostic process is to repair the problem. This step consists of:

1. Form a diagnosis by using all of the information gathered from the troubleshooting that was performed.
2. Physically perform the repair.

The fourth, and hopefully final, step in the troubleshooting process is the follow through. This step consists of:

1. Thoroughly test the repaired equipment: confirming that the initial diagnosis was correct. If it was wrong, start the troubleshooting process over again.

NOTE: Sometimes the engine will have multiple problems at the same time. By performing one repair, other issues may show up that are unrelated to the first repair.

2. Delivery to customer: We are not just repairing equipment, we are repairing customers.
 - Inoculate against recurring problem with education, e.g.... if the problem was caused by stale fuel, make sure the customer is aware that fuel goes bad over time.
 - Make sure the customer understands the repair, preventing "superstitious" come-backs.

Diagnostic tests

When troubleshooting an engine, the diagnostic tests are done in a specific order. The order is:

1. Compression testing
2. Ignition testing
3. Carburetor/fuel system testing.

NOTE: A prime test is a handy short cut. It will test compression and ignition in a single step. If the engine will start from a prime test, the problem is in the fuel system. If the engine will not start with the prime, the compression and ignition tests will need to be performed.

Prime test

To perform a prime test:

1. Prime the engine through the carburetor throat using a squirt bottle, filled with clean fresh gasoline/oil mix.

NOTE: Inspect the air filter while priming the engine. Look for a dirty or plugged filter that could prevent air flow or a missing filter that would indicate dirt ingestion.

2. Make sure the ignition switch is in the run position.
3. Attempt to start the engine.
4. If the engine starts and runs long enough to burn the prime, the problem is effectively isolated to the fuel system. proceed to Chapter 5: The Fuel System and Carburetor.
5. Check ignition system as described in Chapter 4: Ignition.
6. Test compression.

P25 Series of Engines

Compression testing

To perform a compression test:

NOTE: If the engine will run, start the engine and let it warm up first for a better reading.

1. Disconnect the high-tension lead from the spark plug and ground it well away from the spark plug hole.
2. Remove the spark plug using a 5/8" spark plug socket.
3. Pull the starter rope several times to purge any fuel or oil from the combustion chamber.

NOTE: Air compresses readily, liquid does not. Liquid in the combustion chamber will result in an artificially high compression reading.

4. Install a compression gauge in the spark plug hole.
5. Confirm that the gauge is "zeroed", then pull the starter rope repeatedly, until the needle on the gauge stops rising. See Figure 3.1.
6. Read the gauge.

NOTE: When checking compression on small displacement engines, use a compression gauge set with the shortest available (or no) hose.

Interpreting compression readings:

Readings in psi	Possible causes
<90 (6.2 Bar)	Worn rings and/or a scored cylinder.
90 - 145 (6.2 - 10 Bar)	Normal readings
>145 (>10 Bar)	Hydraulic lock

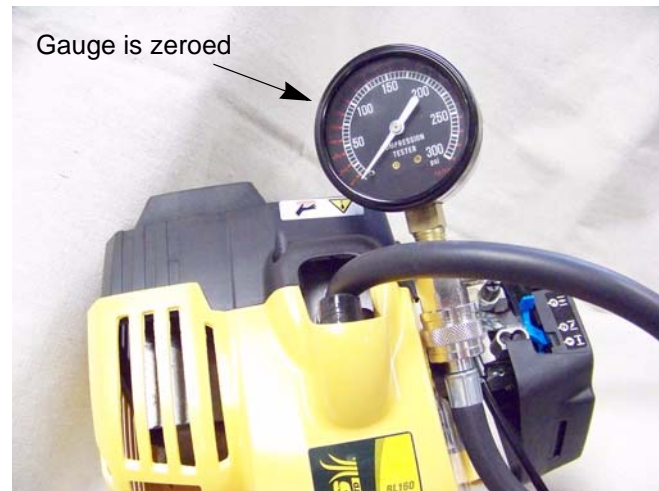

Figure 3.1

CHAPTER 4: IGNITION

Troubleshooting the Ignition System

The purpose of the ignition system is to provide a spark in the combustion chamber at the proper time to ignite the fuel/air mixture.

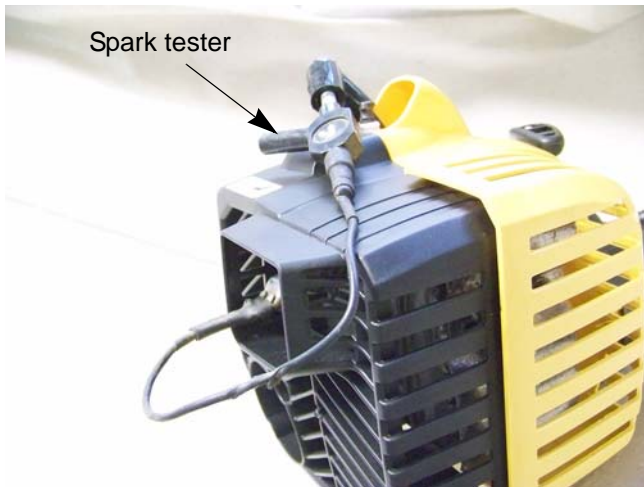

Figure 4.1

To troubleshoot the ignition system:

1. Examine the spark plug by following the steps described in the spark plug section of this chapter.
2. After examining the spark plug, reinstall it, or a new one to ensure a good spark plug is being used.
3. Disconnect the spark plug wire.
4. Connect a spark tester to the spark plug wire.
5. Connect the other end of the spark tester to the engine block. See Figure 4.1.



Never remove the spark plug and hold it against the engine block to test for spark. The fuel/air mix coming out of the spark plug hole will catch on fire.

NOTE: It only takes 1,000 volts to jump a 0.025" air gap in open atmosphere, it takes 10,000 volts to jump the same gap at 120 psi, therefore an open air spark test is not valid.

NOTE: The spark should be a minimum of 10 Kv (10,000 volts) at pull over speed.



Figure 4.2

6. Make sure the engine stop switch is in the "RUN" position.

NOTE: Since 2005, most stop switches used on MTD handheld products are spring loaded to the "RUN" position when they are released. This prevents no-start situations caused by the customer failing to turn the switch on.

NOTE: Once the engine stop switch is moved to the "OFF" position, it sends a ground signal to the module. The circuitry in the ignition module will latch the primary winding to ground until the engine stops. This prevents the need to hold the switch in the "OFF" position until the engine comes to a complete stop.

7. Rapidly rotate the engine while watching the spark tester for sparks. See Figure 4.2.
8. If no sparks are seen in the spark tester, test the module.

P25 Series of Engines

Testing the module

To test the module:

1. Remove the starter housing by following the procedures described in Chapter 6: Starter.
2. Check the air gap for the module. Set it to 0.010" by following the steps described in the module section of this chapter. See Figure 4.3.
3. Disconnect the red wire.
4. Install the starter as described in the starter section of this chapter.
5. Install the clutch as described in the clutch section of this chapter.
6. Pull the starter rope with the spark tester still hooked up to the spark plug wire.
 - If there is spark now, test the engine stop switch and check the red wire for a short to ground.
 - If there still in no spark, hold a screwdriver against the magnets on the flywheel to feel if they are magnetic. If the magnets are good, replace the module. If not, replace the flywheel.



Figure 4.3

Test the engine stop switch



Figure 4.4

To test the engine stop switch:

1. Open the grip by removing the five screws with a T-20 torx driver.
2. Disconnect the wires from the engine stop switch.
3. Connect an ohm meter or continuity light to the switch.
4. With the switch in the engine run position (I), the meter should indicate no continuity. See Figure 4.4.

NOTE: Most stop switches are spring loaded to the run position when it is released. This prevents no-start situations caused by the customer failing to turn the switch on.



Figure 4.5

5. Hold the switch in the stop position (O). The meter should indicate continuity. See Figure 4.5.
 - If the results are not as described, the switch is bad and should be replaced.
 - If the switch is working properly, there is a short in the wires.

NOTE: If there is reason to suspect that the ignition timing is off:

- Remove the starter by following the steps described in Chapter 6: Starter.
 - Make sure the module air gap is correct by following the steps described in the module section of this chapter.
 - Inspect the flywheel. If the flywheel is damaged, replace the flywheel.
 - Remove the flywheel by following the steps in the flywheel section of this chapter.
 - Inspect the flywheel key, if damaged replace the key.
 - Inspect the key way on the crank shaft for damage, if damaged short block the engine.
6. Assemble and test run the engine before returning it to service.

P25 Series of Engines

Module

Remove the ignition module:

1. Remove the starter by following the procedures described in Chapter 6: starter.

2. Disconnect the red wire from the module. See Figure 4.6.

NOTE: The black wire will come off with the module mounting screws.

3. Remove the module by removing the two screws.

4. To install the module, turn the flywheel so that the magnets are away from the module.

5. Install the two screws half way. Do not tighten them down.

NOTE: Make sure the black wire is on the proper mounting screw. See Figure 4.6.

6. Place a non-magnetic, 0.010" feeler gauge on the flywheel magnets and rotate the flywheel until the magnets line up with the module. Let the magnets draw the module against the flywheel with the feeler gauge trapped between them. See Figure 4.6.

NOTE: The air gap range is 0.010" - 0.015" (0.25 - 0.38mm).

7. Torque the module screws to 30 - 40 in lbs (3 - 5 Nm).

8. Reassemble the engine by following the above steps in reverse order.

9. Test run the engine in a safe area before returning it to service.

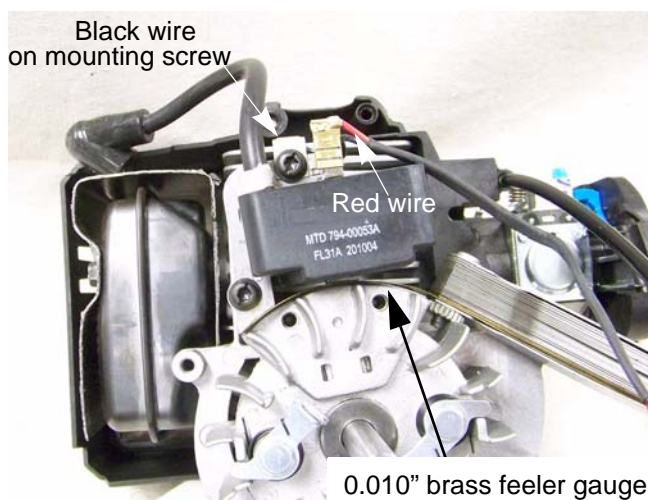

Figure 4.6

Flywheel

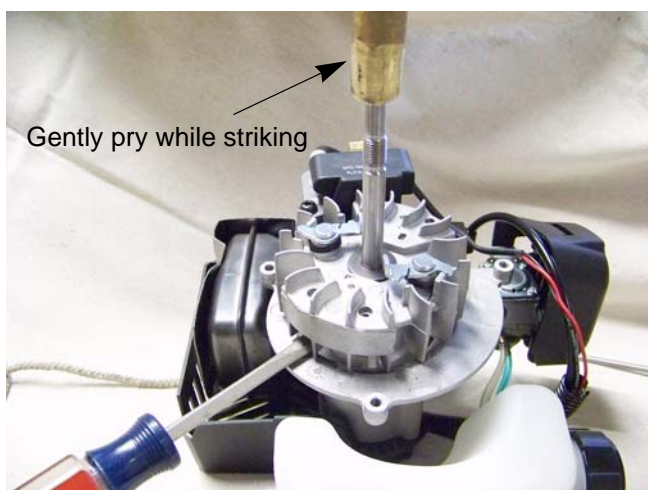

Figure 4.7

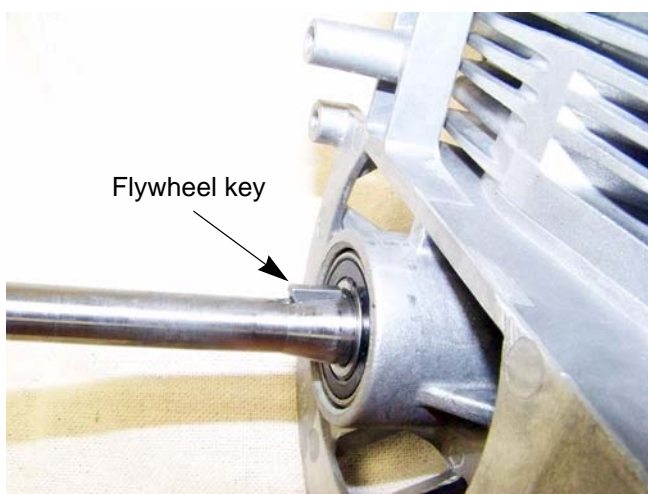

Figure 4.8

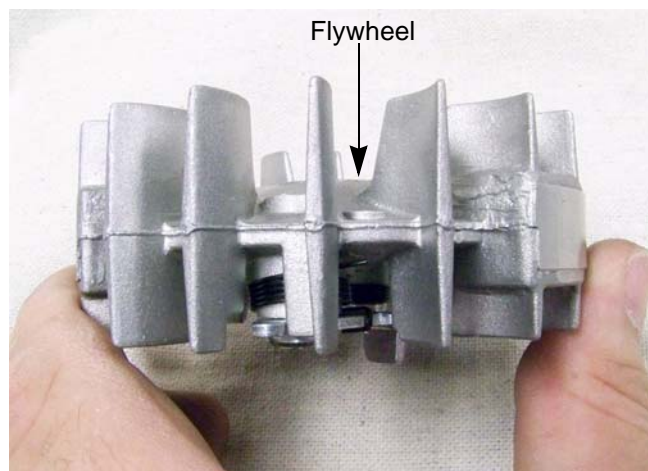

Figure 4.9

The flywheel of an engine performs four functions:

- It stores energy.
- Provides the momentum that keeps the crankshaft rotating between power strokes.
- It times the firing of the ignition module.
- Forces air around the engine for cooling.

To remove the flywheel:

1. Remove the spark plug by following the steps described in Chapter 2: Maintenance.
2. Remove the starter by following the procedures described in Chapter 6: starter.
3. Remove the flywheel by striking the crankshaft with a brass punch. See Figure 4.7.

NOTE: It is not necessary to remove the module to remove the flywheel.

NOTE: The Belleville washer between the flywheel and the spacer may grab the crankshaft like a pawl nut when compressed. To remove the washer, use the flywheel as a slide hammer and drive the washer off of the crankshaft. Discard the damaged washer.

NOTE: Inspect the flywheel key and the crankshaft keyway. See Figure 4.8.

NOTE: The flywheels used on the P25 series of engines are double sided fans for greater cooling capacity. See Figure 4.9.

4. Inspect the flywheel and key for any signs of damage.
5. Install the flywheel by following the previous steps in reverse order.

NOTE: Tighten the clutch to a torque of 210 - 230 in lbs (24 - 26 Nm).

NOTE: Set the module air gap by following the steps described in the previous section of this manual.

6. Test run the engine before returning it to service.

For Parts Call 606-678-9623 or 606-561-4983

P25 Series of Engines

CHAPTER 5: FUEL SYSTEM AND CARBURETOR

The function of the fuel system is to store fuel/oil mixture, mix the fuel/oil with air and deliver it to the combustion chamber. The fuel system consists of the following components:

- Fuel tank
- Fuel lines
- Fuel filter
- Carburetor

NOTE: When working on the fuel systems, look at the whole system. A problem will rarely be isolated to one component.

Fuel system troubleshooting

When troubleshooting the fuel system, all of these steps should be followed:

NOTE: A compression test must be performed before troubleshooting the fuel system. The fuel system will not work properly with a compression reading less than 90 psi (6.2 bar).

1. Drain the fuel.
2. Inspect the fuel.
3. Check the fuel/oil mixture.
4. Test for alcohol.
5. Inspect the fuel filter.
6. Inspect the fuel lines.
7. Check the fuel tank vent.
8. Inspect the primer.



Gasoline is extremely flammable and the vapors are explosive. Avoid all sources of heat when working on the fuel system.

Inspecting the fuel

NOTE: Fuel is the maintenance item most often overlooked by consumers. A lot of fuel system problems are caused by bad gasoline. When inspecting the fuel:

- Look for water.
- Look for dirt.
- Look for discoloration.
- Sniff carefully to see if it smells like varnish or kerosene.
- Save the fuel to show to customer.

NOTE: Save a sample of the fuel collected to show the customer.

P25 Series of Engines

Check the fuel/oil mixture

To check the fuel in the carburetor:

1. Get a plain piece of paper.
2. Divide it into four sections and label them:
 - Plain gas
 - Two cycle mix
 - Gas from carburetor
 - Straight oil
3. Get a sample of fuel from the carburetor and pour it on the section of the paper labeled sample from carburetor. See Figure 5.1.

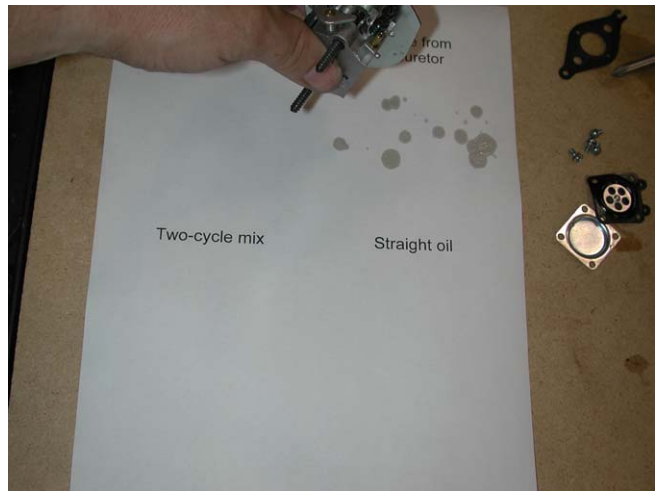

Figure 5.1

4. Place a sample of two cycle mix where it says two cycle mix, straight gas with straight gas and straight oil with straight oil. See Figure 5.2.

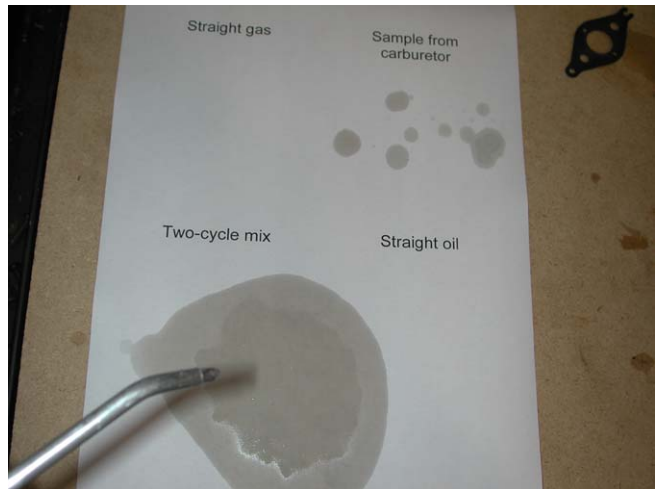

Figure 5.2

5. Match the sample from the carburetor to the other three samples. This will show if the proper mix is being used or not. See Figure 5.3.
6. Before returning to service, put fresh fuel/oil mix in the fuel tank.

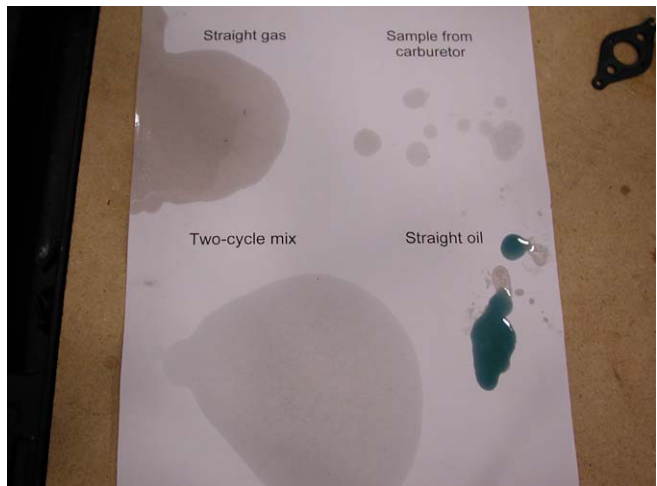

Figure 5.3

Test fuel for alcohol

Fuels currently on the market contain a wide array of additives. Some of these additives oxygenate the fuel. Oxygenated fuel reduces emissions, and is required in some parts of the United States. Fuel make-up varies seasonally and geographically. Ethanol is the primary additive used to oxygenate fuel.

Ethanol in fuel creates a lot of problems for gasoline engines. The biggest problem is that alcohol attracts and holds water. This corrodes the metal components of the fuel system, especially the carburetor. Alcohol also does not produce as much heat as gasoline when burnt. This results in less power for the engine.

The ideal fuel/air mixture ratio (stoichiometric ratio) for an engine burning alcohol is much richer than the stoichiometric ratio an engine running on gasoline. An engine tuned to run on gasoline will not run well on alcohol. The more alcohol there is in the fuel beyond the 10% that is anticipated, the further the fuel/air mixture will be from the correct ratio.



Figure 5.4

A 10% ethanol (E10) mix is acceptable for MTD engines. Anything higher than that will result in performance issues.

NOTE: E20 and E85 fuels are not to be used in any MTD engines.

There are several alcohol test kits available commercially. See Figure 5.4.



Figure 5.5

Generally these kits involve mixing a measured amount of water and gas together and seeing where the boundary layer is. See Figure 5.5.

The test kit should come with a chart to compare the boundary layer height to alcohol percentage.

P25 Series of Engines

Fuel filter

A dirty fuel filter can result in a lean run condition. The fuel filter should be inspected every 25 hours of use.

NOTE: The weighted fuel filter (clunk) keeps the filter submerged in the fuel at any angle of operation. The filter removes dirt and air bubbles from the fuel. Running the trimmer without the filter may allow air into the fuel line creating a lean run condition at higher RPMs. This will cause a catastrophic failure of the engine.

NOTE: Starting in 2012, EPA guidelines will mandate that all handheld engines produced have low permeation fuel lines. These fuel lines do not stand up to the removal/installation methods used in the field. Because of this, the fuel filter and fuel lines are serviced with the fuel tank.

To inspect the fuel filter:

1. Bend a piece of wire to make a hook.
See Figure 5.6.
2. Remove the gas cap.



Figure 5.6

3. Stick the hook end of the wire into the fuel tank and fish out the fuel filter. See Figure 5.7.
4. Inspect the filter for signs of dirt or damage.
NOTE: If the filter is dirty or damaged, the whole fuel tank assembly must be replaced.
NOTE: Pay close attention to the fuel line. If they are discolored or brittle, replace the fuel tank assembly.
5. Place the filter back inside the fuel tank.
6. Test run the engine before returning it to service.

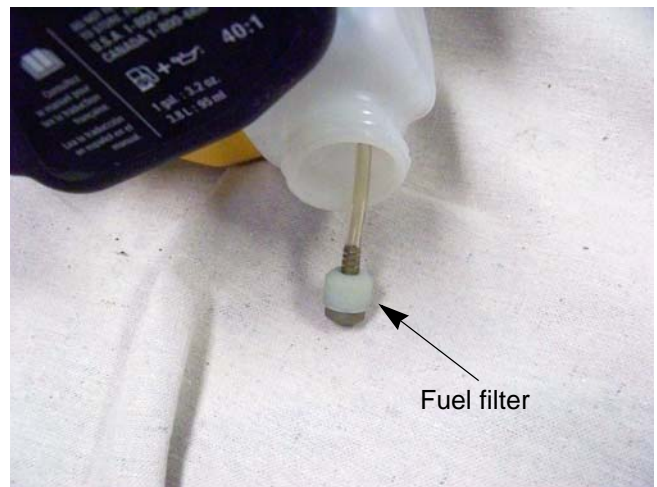

Figure 5.7

Fuel lines

- The carburetor contains a pump that draws fuel through the filter and up the fuel line. A hardened fuel line that has cracked or does not seal tightly to a fitting may draw air into the line without leaking fuel out.
- Air leaks will reduce the fuel pumps ability to supply the carburetor.
- Clear line = fuel supply
- Blue line = return from primer to tank
- Black fuel lines = low permeation fuel line

NOTE: MTD started using low permeation fuel lines on some of the P25 series of engines in 2009. In 2012, all MTD hand held engines will have the low permeation fuel line to comply with EPA guidelines. The low permeation fuel lines can be identified by their black color.

IMPORTANT: Low permeation fuel lines can NOT be serviced separately. They must be replaced as part of the fuel tank assembly.

Inspect the fuel lines:

- Are they cracked?
- Are they clogged?
- Are they brittle?

NOTE: If the answer to any of the above is yes, the fuel tank assembly must be replaced.

Fuel tank vent

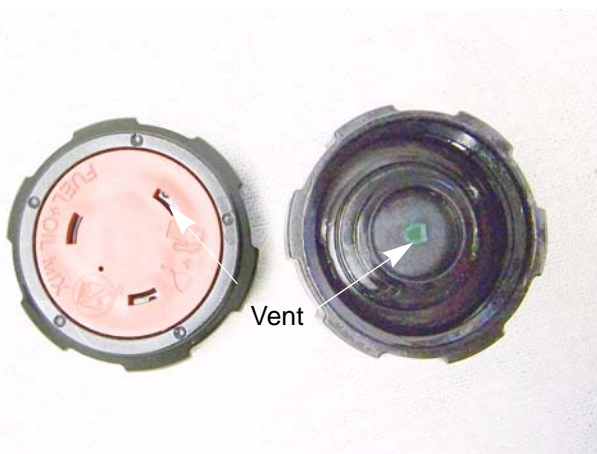

Figure 5.8

The fuel cap is vented. Ensure that the vent is clean and working properly. See Figure 5.8.

P25 Series of Engines

Fuel tank

To remove/replace the fuel tank:

1. Drain the fuel tank.
2. Disconnect the fuel lines from the carburetor.
See Figure 5.9.
3. Remove the two screws that hold the fuel tank to the starter housing using a T-20 torx driver.
See Figure 5.10.
4. Slide the tank out to the rear.
5. Install the fuel tank by following the previous steps in reverse order.

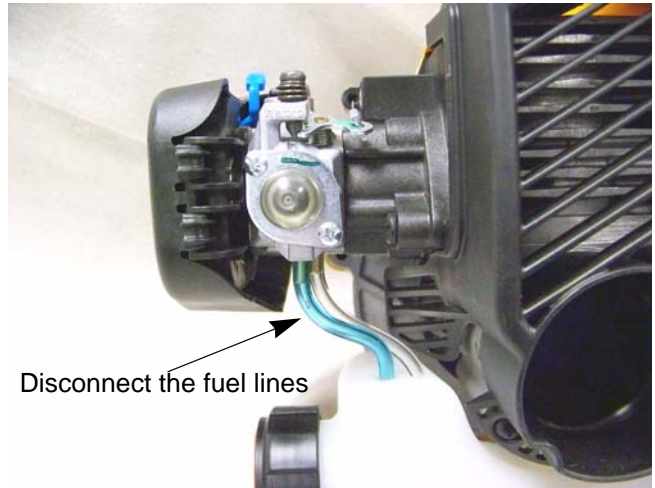

Figure 5.9

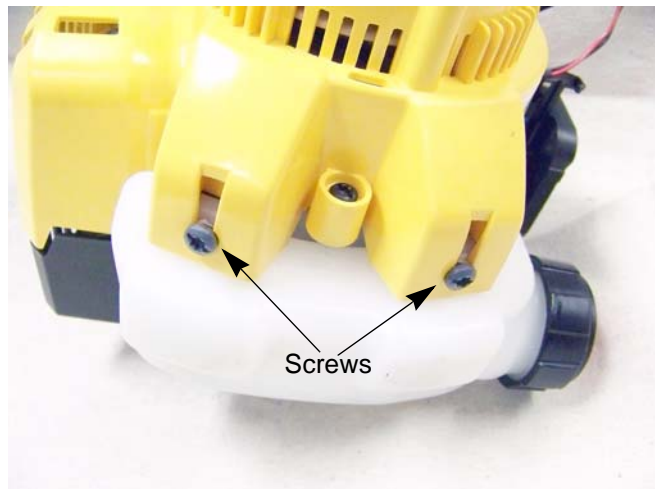

Figure 5.10

Carburetor

The P25 series of engines uses the Walbro WT series carburetors, or a carburetor of similar design from another manufacturer.

The main distinguishing features of this carburetor design are:

- It has a butterfly valve, not a rotary throttle valve.
- The primer bulb is mounted on the carburetor.

NOTE: The carburetors used on the P25 engines are adjusted to meet federal emissions standards on the assembly line using tamper proof needle screws. EPA and CARB standards do not allow for adjusting of these screws once the finished product leaves the manufacturer.

Troubleshooting the carburetor

Typically, troubleshooting the carburetor is the last step in the diagnostic process. The other factors are more readily identified; spark vs. no spark, specific pressure readings on a compression gauge, or a visible blockage in the muffler. Carburetor function is more subtle. While specific problems with a carburetor can be identified on tear-down, identification of the carburetor as the location of the problem is usually done by process of elimination.

Treat the carburetor as part of a system. If damaged fuel lines or a blocked filter prevent the carburetor from getting fuel, it will never work right.



Figure 5.11

To troubleshoot the carburetor:

1. Check the operation of the primer. When the bulb is depressed and released, fuel should move through the lines.

NOTE: This is a wet bulb primer. It draws fuel from the fuel tank through the pump and diaphragm chambers and pumps it back into the tank, purging the air from the carburetor. The primer will not squirt fuel into the throat of the carburetor as dry bulb primers do.

2. Remove the air filter cover.
3. Remove the two screws in the air filter housing with a T-25 torx driver. See Figure 5.11.

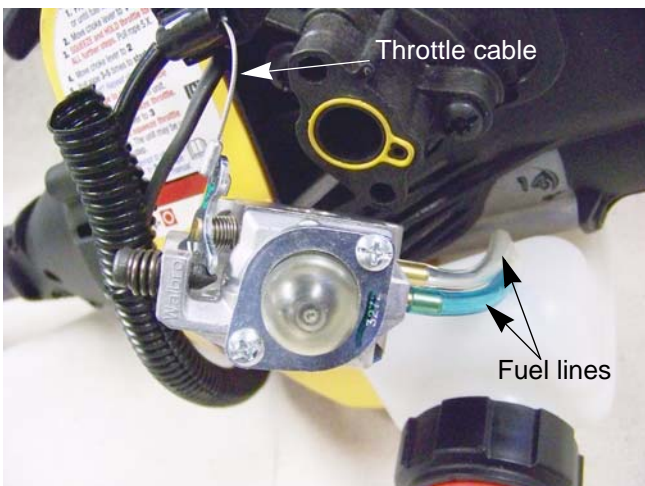

Figure 5.12

4. Disconnect the fuel lines. See Figure 5.12.
5. Disconnect the throttle cable from the carburetor.

P25 Series of Engines

6. If the fuel/air mixture is lean:
 - Inspect the carburetor spacer for cracks.
 - Inspect the spacer O-ring.

NOTE: A cracked spacer or a leaking O-ring between the spacer and the cylinder or the spacer and the carburetor could result in a lean run condition or prevent the impulses from the engine from driving the fuel pump. See Figure 5.13.

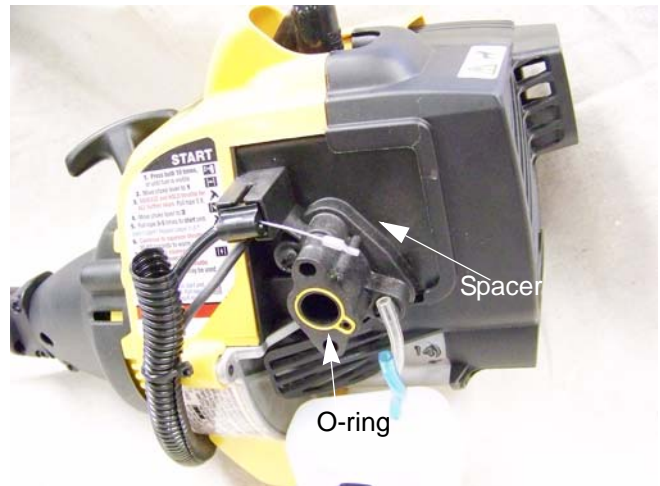

Figure 5.13

7. Inspect the butterfly valve assembly for debris and freedom of movement. See Figure 5.14.
8. Perform a needle valve pop off test by following the carburetor manufacturer's recommendations.
9. If there is a problem with the carburetor, check on availability and price of parts to determine if the carburetor should be repaired or replaced.

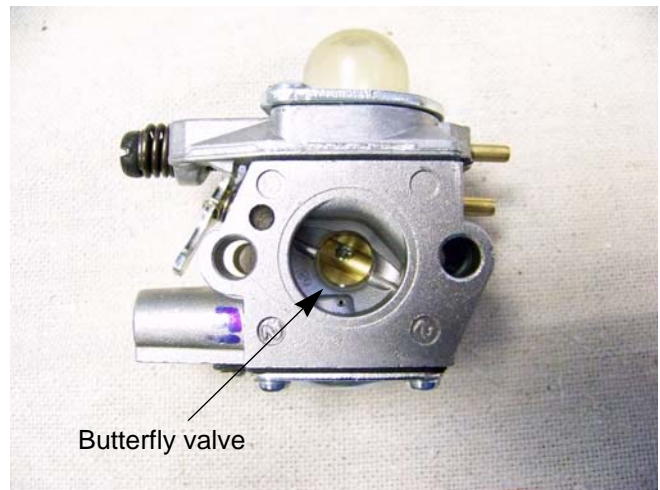

Figure 5.14

Fuel System And Carburetor

Disassembly of the carburetor

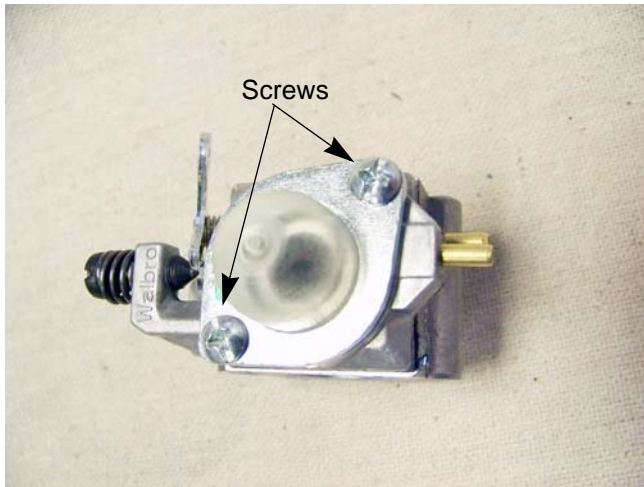

Figure 5.15

1. Remove the two screws that hold the primer pump body and the primer bulb to the carburetor using a #2 phillips screwdriver. See Figure 5.15.

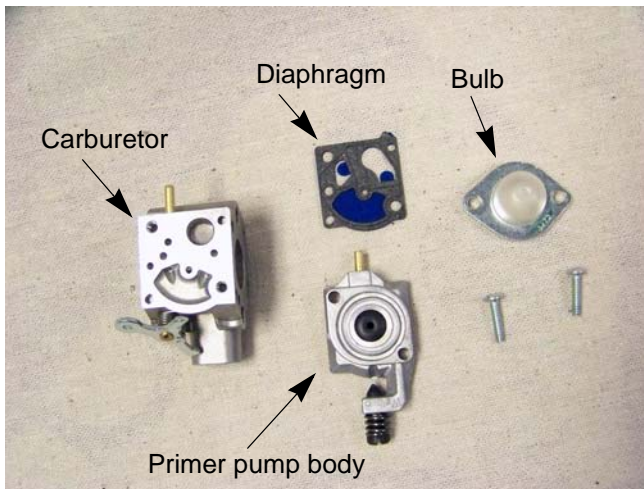

Figure 5.16

2. Separate the primer pump and the bulb assembly, placing each part on the bench in the order they came apart. See Figure 5.16.
3. Inspect the diaphragm and gasket. If torn, damaged or brittle install a diaphragm kit.
4. Inspect the primer bulb.
5. Inspect the inside of the pump chamber for dirt or varnish build up.

NOTE: If there is a lot of dirt/varnish, replace the carburetor.

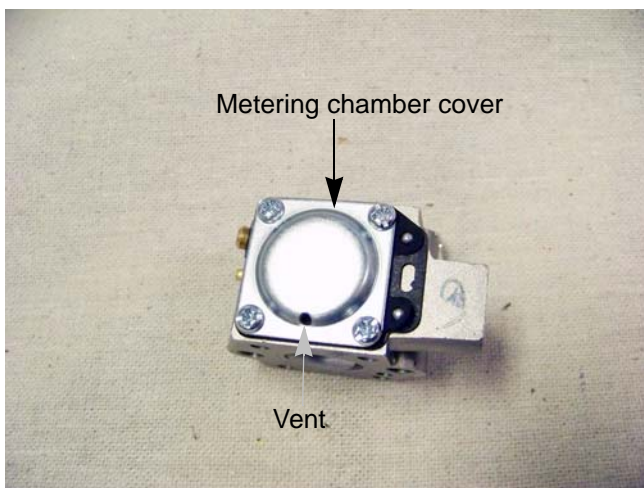

Figure 5.17

6. Remove the four screws that secure the metering chamber cover to the carburetor using a #2 phillips screwdriver. See Figure 5.17.

P25 Series of Engines

7. Inspect for dirt or varnish build up inside the carburetor. If there is a lot of dirt/varnish in the carburetor, replace it. See Figure 5.18.
8. Check that the needle valve is set to the right height. See the carburetor manufacturer for the proper procedure.

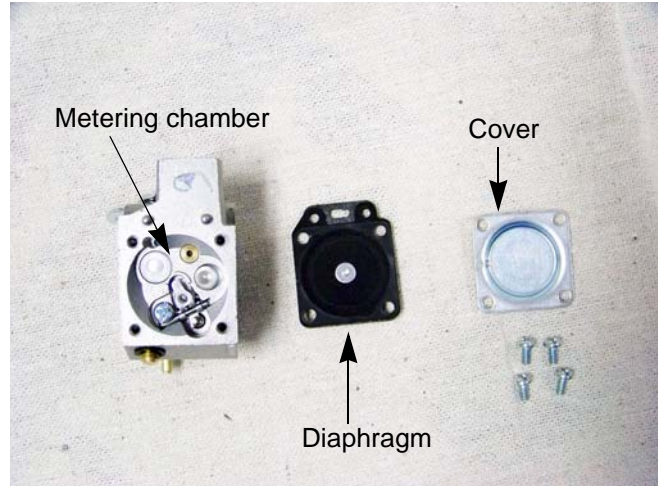

Figure 5.18

9. Inspect the metering valve and the metering valve seat for dirt and/or pitting. See Figure 5.19.
10. If the seat is damaged, replace the carburetor.



Figure 5.19

NOTE: If there is a minor amount of dirt/varnish in the carburetor, it would be worth while to clean and rebuild the carburetor by following the procedures recommended by the carburetor manufacturer.

NOTE: If there is a lot of dirt/varnish in the carburetor, replace the carburetor.

NOTE: The alcohol in gasoline is hygroscopic, meaning that it readily absorbs moisture. The moisture that is trapped in the alcohol leads to corrosion of metal parts. See Figure 5.20.

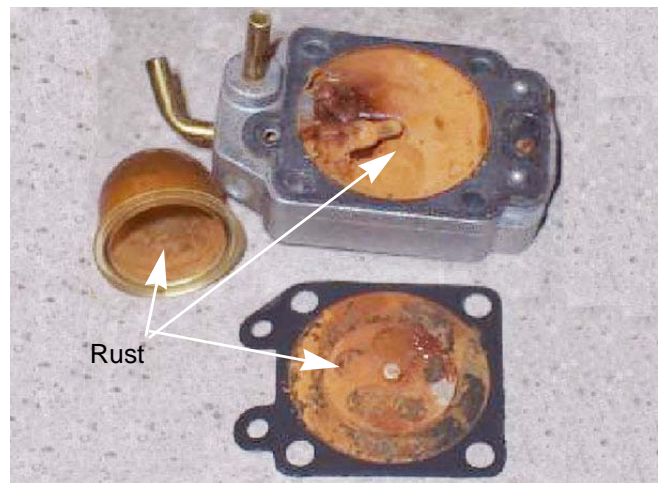

Figure 5.20

Fuel System And Carburetor

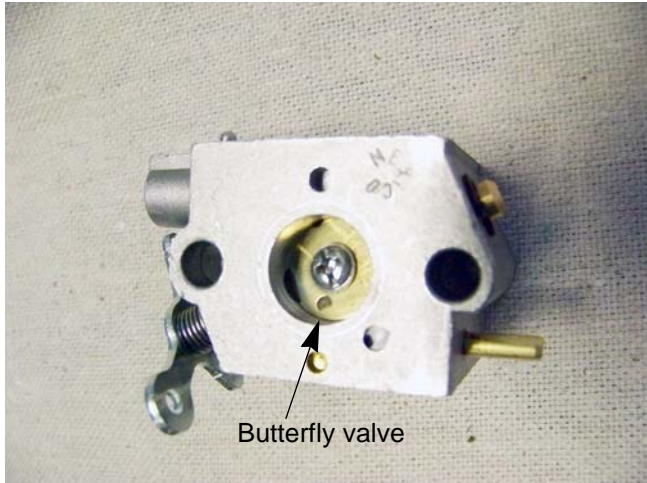

Figure 5.21

11. Remove the throttle plate using a #2 phillips screwdriver. See Figure 5.21.

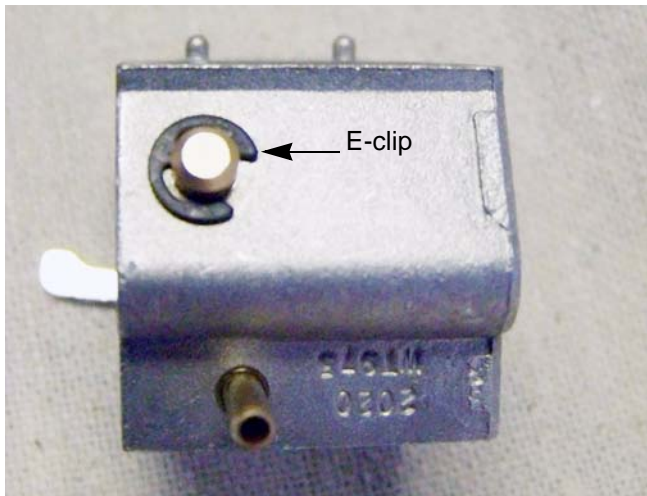

Figure 5.22

12. Remove the throttle shaft E-clip. See Figure 5.22.
13. Slide the throttle shaft out of the carburetor.

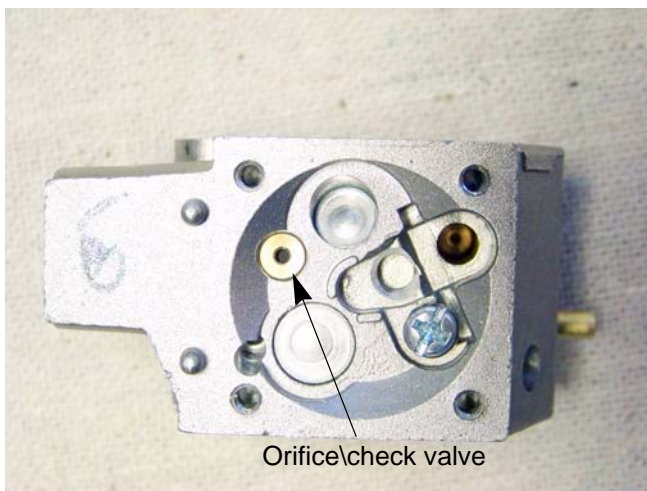

Figure 5.23

14. The orifice\check valve can also be seen from the pump side of the throttle housing. See Figure 5.23.

P25 Series of Engines

NOTE: The fuel pump in the carburetor is driven by pressure pulses in the crank case. The impulse port from the spacer lets the pulses pass through the carburetor body into the pump chamber. See Figure 5.24.

15. Make sure these ports are clean and free of debris.

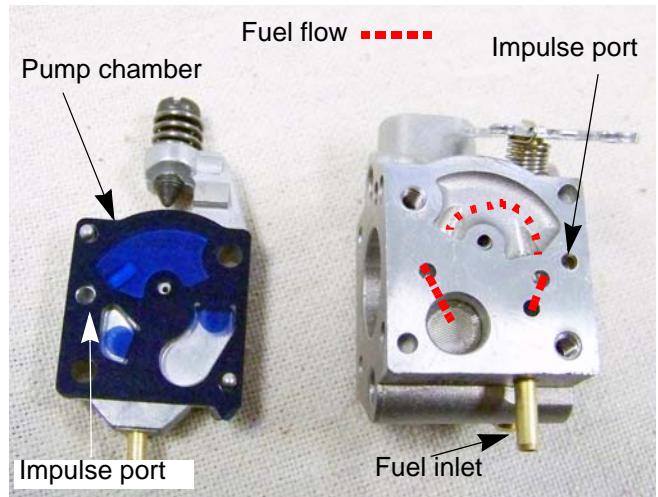

Figure 5.24

Re-assembly of the carburetor

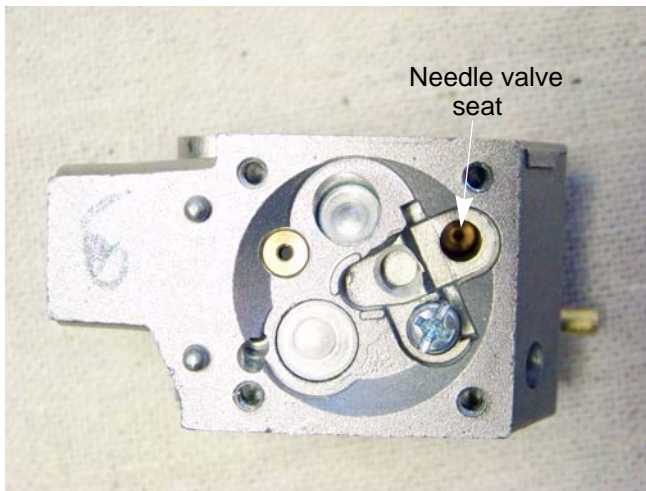

Figure 5.25

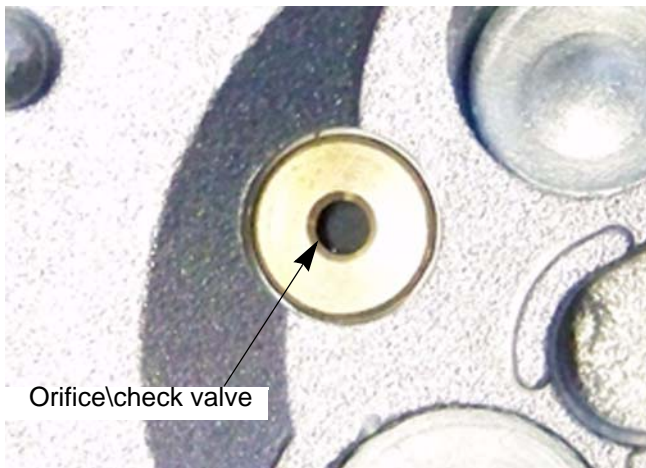

Figure 5.26

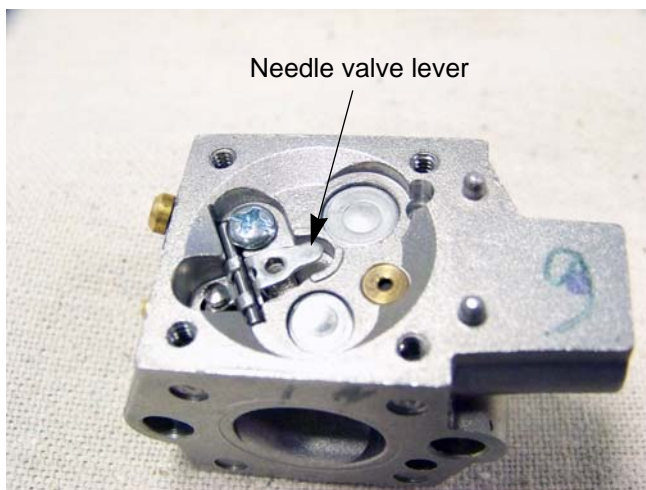

Figure 5.27

NOTE: The carburetor used in this manual is a Walbro. Depending on the application, the engine may have a different carburetor. All carburetors have a manufacturer name cast on them. Contact the carburetor manufacturer for the proper rebuild procedure.

1. Place the carburetor in a clean area on the work bench.
2. Inspect the needle valve seat assembly.
3. If the needle valve seat is damaged, replace the carburetor. See Figure 5.25.
4. Install the throttle valve assembly.
5. Clean the metering orifice\check valve with carburetor cleaner.

CAUTION Do not insert anything into the orifice to clean it. That will damage the orifice resulting in the carburetor being unreparable. See Figure 5.26.

6. Install the needle valve, valve lever and spring as one assembly.
7. Tighten the hold down screw using a #2 phillips screwdriver.
8. Set the needle valve lever as per the carburetor manufacturer's recommendations using a W-tool. See Figure 5.27.
9. Install the gasket and diaphragm.
10. Install the cover.

P25 Series of Engines

11. Inspect the primer pump body for dirt and/or varnish. See Figure 5.28.
12. Install the diaphragm and gasket.
13. Install the primer pump body and the primer bulb.
14. Tighten the screws using a #2 phillips screwdriver.
15. Perform a needle valve pop off test by following the carburetor manufacturer's recommendations.
16. Install the carburetor on the engine.
17. Test run the engine before returning it to service.

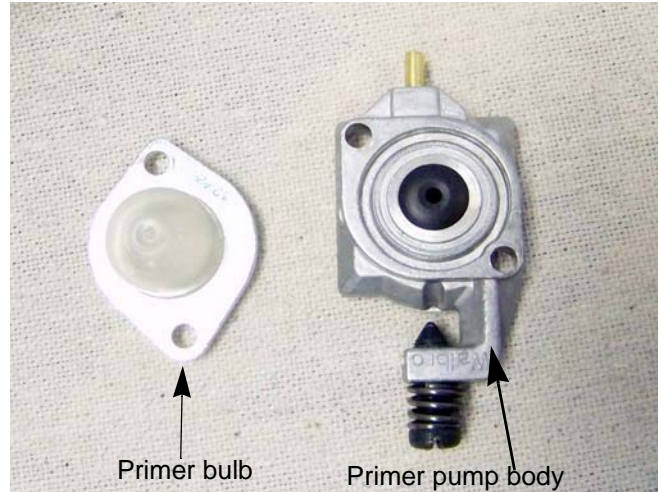

Figure 5.28

Fuel System And Carburetor

Carburetor insulator



Figure 5.29

NOTE: A cracked spacer or a leaking gasket between the spacer and the cylinder could result in a lean run or prevent the impulses from the engine from driving the fuel pump.

To remove/replace the carburetor insulator:

1. Remove the carburetor by following the procedures described in the carburetor section of this chapter.
2. Remove the throttle cable by pressing in the tabs located in the slots while lifting the cable out. See Figure 5.29.

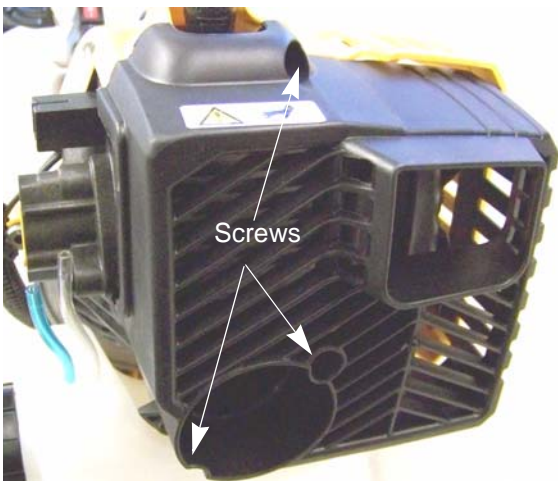

Figure 5.30

3. Remove the three screws that secure the engine cover to the engine using a T-20 torx driver. See Figure 5.30.
4. Slide the engine cover off of the rear of the engine.



Figure 5.31

5. Remove the carburetor insulator block using a T-25 torx driver. See Figure 5.31.

P25 Series of Engines

6. Inspect the O-ring between the insulator block and the cylinder. See Figure 5.32.
7. Install the insulator by following the previous steps in reverse order.

NOTE: Apply a small amount of releasable thread locking compound such as Loctite® 242 (blue) to the carburetor insulator block to cylinder screws. Tighten them to a torque of 45 - 50 in lbs (5 - 6 Nm).

8. Test run the engine before returning it to service.



Figure 5.32

CHAPTER 6: STARTERS

Recoil Starter Removal



Figure 6.1

To remove the starter assembly:

1. Remove the clutch following the steps described in the section on clutch removal.

NOTE: The drive shaft will come off with the clutch housing.

2. Remove the screw that hold the engine cover to the starter housing using a T-20 torx driver. See Figure 6.1.

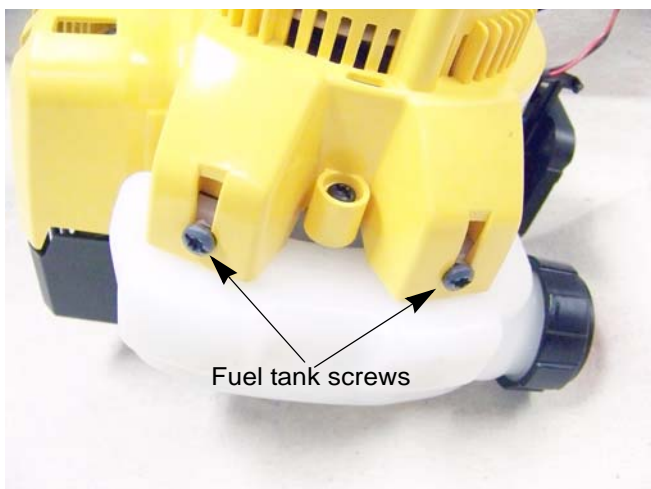

Figure 6.2

3. Remove the two fuel tank mounting screws using a T-20 torx driver.
4. Slide the fuel tank out of the starter housing.

P25 Series of Engines

5. Remove the three screws in the front of the starter housing. See Figure 6.2.
6. Slide the starter housing off of the engine.
7. Install the starter assembly by following the previous steps in reverse order.
8. Test run the engine before returning it to service.

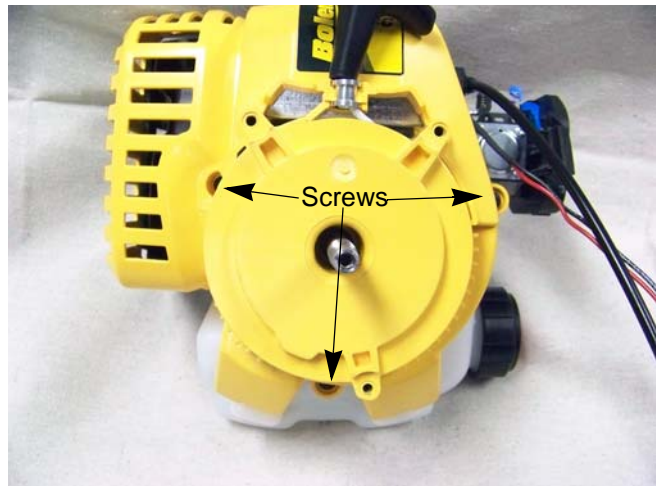

Figure 6.3

The starter rope, pulley and springs

The 25cc P25 series of engines are equipped with the Assist Spring Technology (AST) starters. The AST system allows the customer to pull the recoil rope at any pace they please, yet still generate enough force to start the engine.

The system is simple, and adds a grand total of two parts to the trimmer: a recoil pulley assembly, which includes an accumulator spring. As the rope is pulled, the accumulator spring winds-up. When the force on the accumulator spring over-comes the engine compression, it releases its accumulated energy, spinning the crankshaft rapidly.

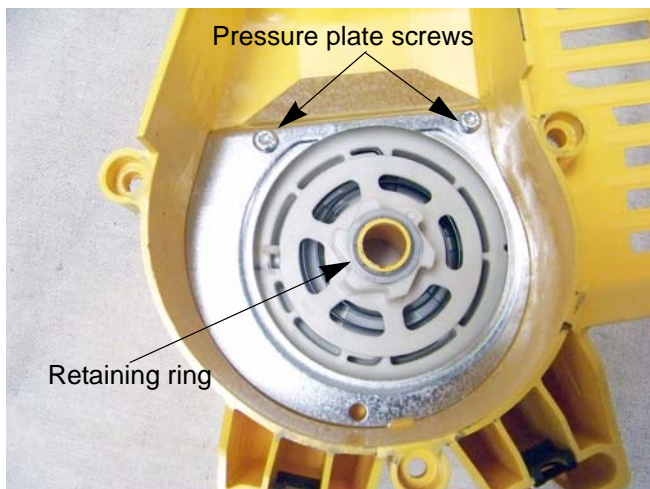

Figure 6.4

To service the rope, pulley and springs:

CAUTION Eye protection should be worn when working on these starters. There are 2 clock springs inside that can come out of the starters at a great velocity.

1. Remove the starter housing assembly by following the procedures described in the previous section of this chapter.
2. Remove the two screws securing the pressure plate to the housing using a T-20 torx driver.
3. If the recoil rope has not already been de-tensioned by breakage, remove the starter handle and relieve tension from the rope.
4. Cut off the starter pulley retaining ring.
5. Carefully remove the pulley and starter assist (accumulator) spring. See Figure 6.5.

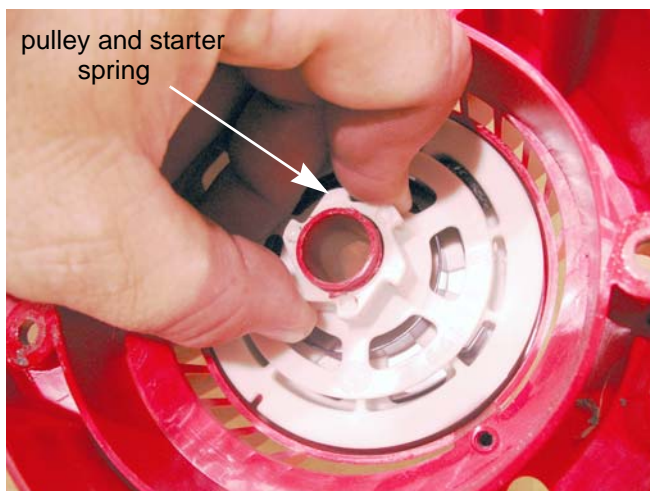

Figure 6.5

P25 Series of Engines

NOTE: The recoil pulley assembly consists of three parts, but it is serviced as one assembly. The three parts are: the inner pulley, the starter assist (accumulator) spring, and the outer pulley. See Figure 6.6.

NOTE: When the recoil rope is pulled, it rotates the outer pulley, winding-up the starter assist spring. When the spring accumulates enough force to over-come the compression of the engine, it releases its energy, spinning the inner pulley and the flywheel rapidly. This allows the operator to pull the recoil rope slowly, yet still generate enough cranking speed to start the engine.

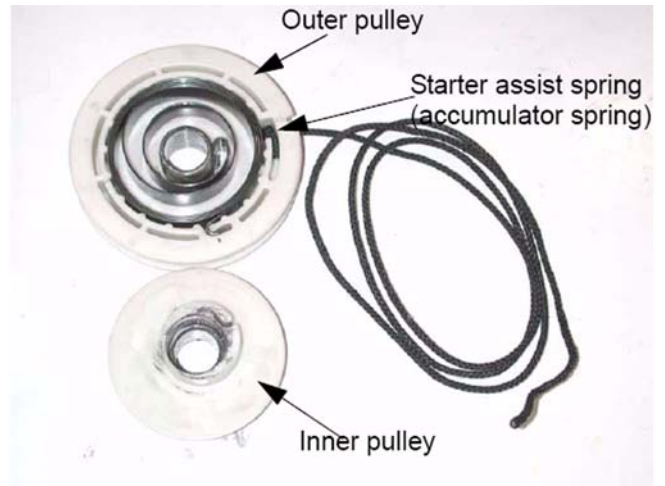

Figure 6.6

NOTE: In the starter housing, there is an enclosed recoil spring. If the Starter rope failed to retract, carefully remove the enclosed recoil spring for inspection. Otherwise leave the enclosed spring in place. See Figure 6.7.

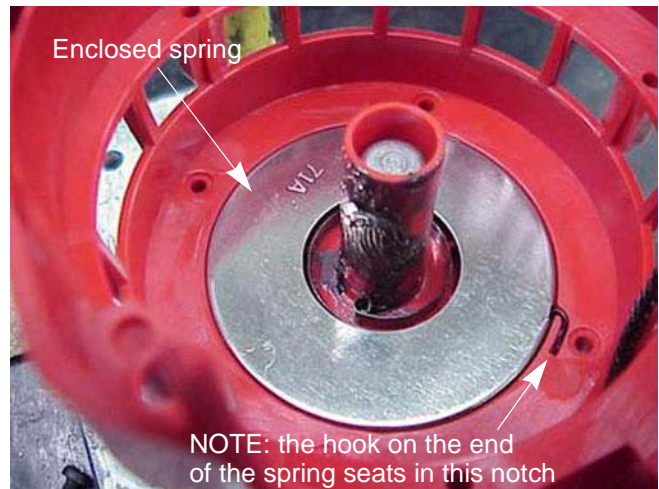

Figure 6.7

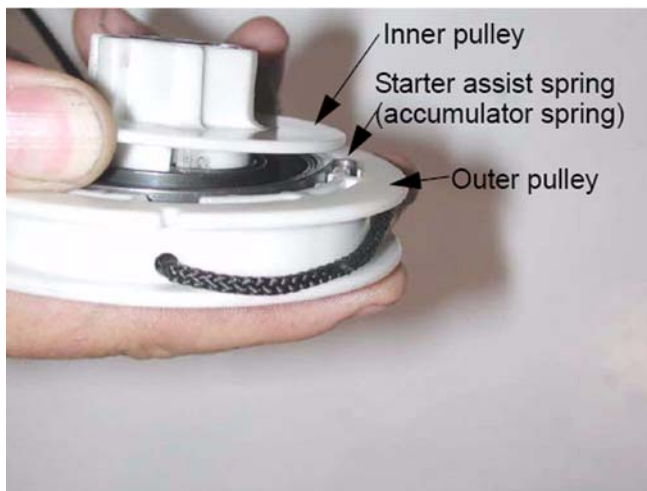

Figure 6.8

To assembly the starter pulley assembly:

1. Install a new starter rope in the recoil pulley assembly.
 - 1a. Remove the old rope from the pulley.
 - 1b. Cut a piece of #3 1/2 (7/64") starter rope 43" (109 cm) long.
 - 1c. Insert the new piece of rope through the hole in the starter pulley.
 - 1d. Tie a half hitch knot at the end of the rope.
 - 1e. Press the knot into the groove in the starter pulley.



Figure 6.9

2. Lightly lubricate the post that the recoil pulley assembly fits over with a good quality lithium base grease.

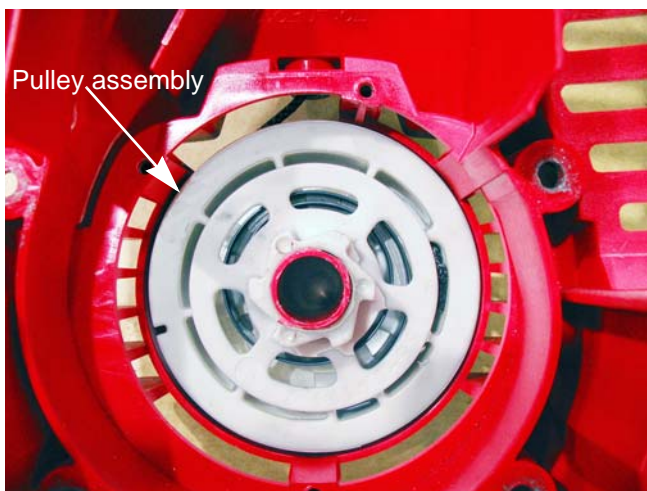

Figure 6.10

3. Install the pulley assembly into the starter housing assembly. See Figure 6.10.
4. Install a new retaining ring.
5. Pass the free end of the starter rope through the eyelet in the starter housing.
6. Tie a slip knot in the recoil rope to keep it from getting pulled back through the eyelet.
7. Wind the rope onto the pulley until there is enough tension to consistently draw the recoil handle up against the eyelet.

P25 Series of Engines

8. Secure the recoil handle to the rope using two half hitch knots. See Figure 6.11.
9. Release the slip knot.



Figure 6.11

10. Install the pulley retainer using a deep socket to apply even pressure to the retainer while driving it into place. See Figure 6.12.



Figure 6.12

NOTE: The central post has a shoulder on it that acts as a stop for the pawl nut. Drive the pawl nut down till it stops. See Figure 6.13.

11. Test the operation of the starter recoil.
12. Install the starter housing assembly by following the procedures described in the previous section of this chapter.
13. Test run the engine before returning it to service.

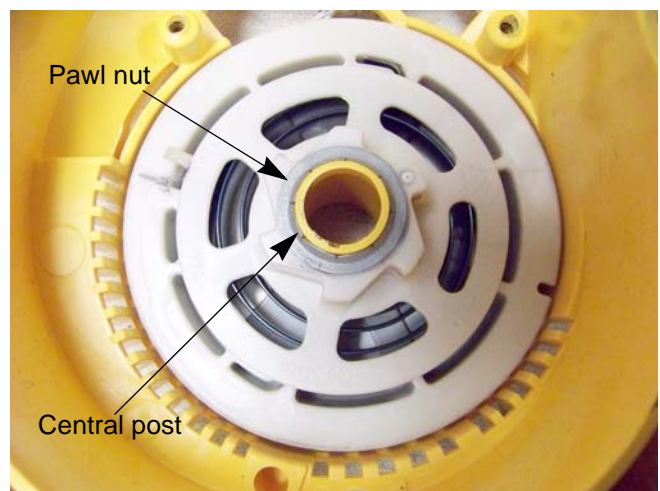

Figure 6.13

CHAPTER 7: CLUTCH AND UPPER DRIVE SHAFT

Drive shaft assembly

There are two types of drive shaft assemblies available with the P25 series of engines:

- Straight shaft
- Curve shaft

NOTE: The procedure to remove the drive shaft assembly from the engine is the same for both styles.

NOTE: The drive shaft assembly consists of the drive shaft housing and a flexible inner drive shaft. The housing and the drive shaft are serviced separately.



Figure 7.1

To remove the drive shaft assembly:

1. Remove the six screws in the grip with a T-20 torx driver. See Figure 7.1.
2. Let the grip hang off to the side.

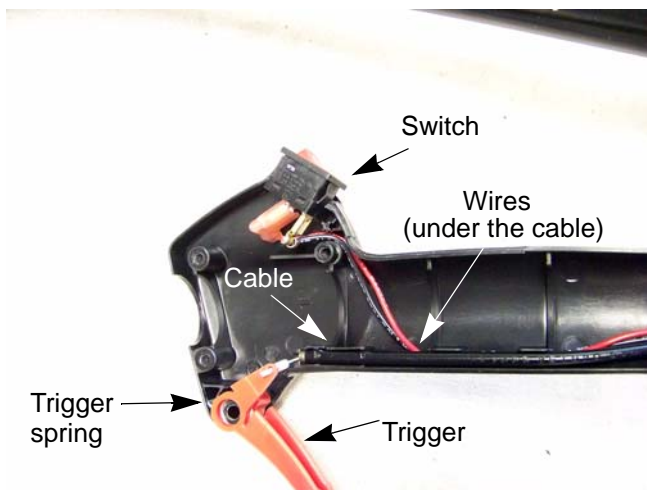

Figure 7.2

NOTE: There are a five parts inside the grip assembly. Be careful that they don't fall out of the grip. See Figure 7.2.

P25 Series of Engines

3. Remove the anti-rotation screw with a T-20 driver.
4. Loosen the clamping bolt with a T-20 driver. See Figure 7.3.
5. Slide the drive shaft housing out of the clutch housing.
6. If replacing the drive shaft housing, remove the handle bar, shield and the trimmer head.

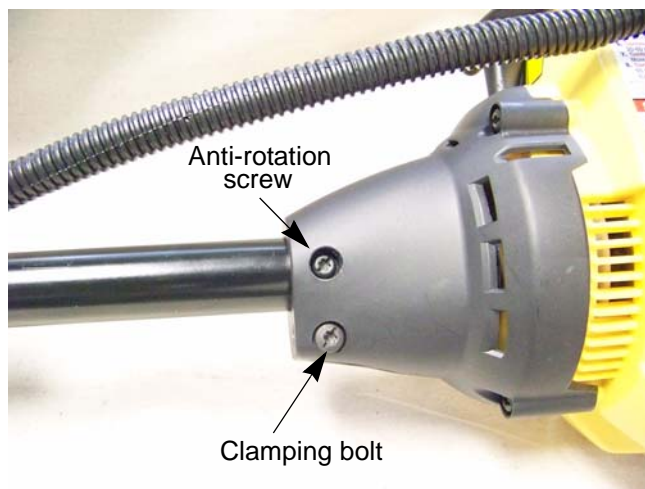

Figure 7.3

7. Slide the drive shaft out of the housing. See Figure 7.4.
8. Follow these steps in reverse order to install the drive shaft assembly.
9. Test run the engine/trimmer before returning it to service.

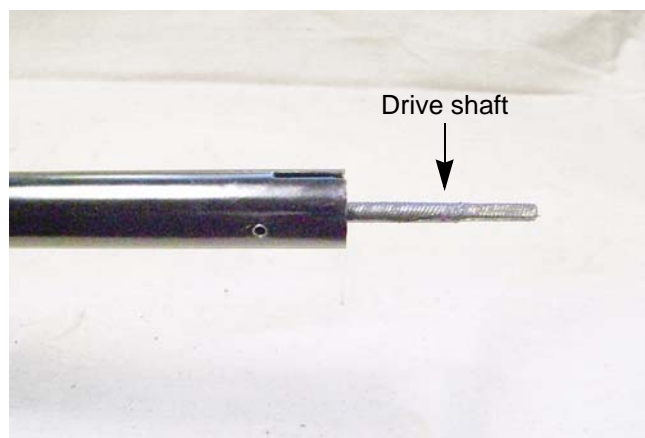

Figure 7.4

Clutch and Upper Drive Shaft

Clutch removal/replacement



Figure 7.5

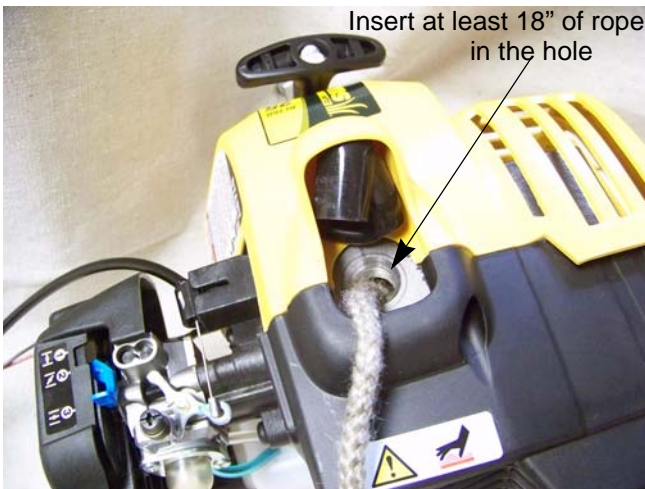

Figure 7.6



Figure 7.7

NOTE: The upper drive shaft may be left connected to the clutch housing. Removing the three screws in the clutch housing will allow the clutch housing and the upper drive shaft to be removed as one.

1. Remove the three screws holding the clutch housing on with a T-20 driver. See Figure 7.5.

2. Disconnect and remove the spark plug.

3. Insert at least 18" (0.5 M) of starter rope in the spark plug hole to keep the crank shaft from rotating. Keep some of the rope out so it can be removed later. See Figure 7.6.

4. Remove the clutch drum by removing the screw in the center of it with a T-20 driver. See Figure 7.7.

P25 Series of Engines

- Remove the clutch rotor with a clutch removal tool.

NOTE: The P25 engines use a rubber clutch. Clutch tool number 797-00070 can be used to remove it. See Figure 7.8.

NOTE: The clutch is used to disconnect the drive shaft for starting. It will engage at 2,000 RPM. This means the trimmer head will spin at idle speed.

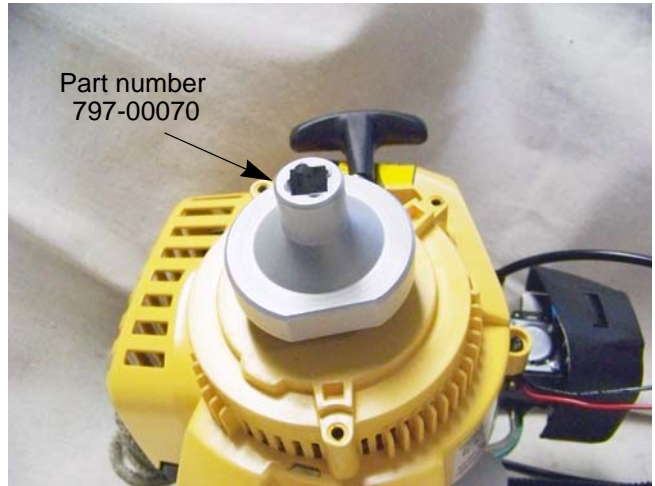

Figure 7.8

- Install the clutch rotor.

NOTE: The big washer goes between the rotor and the starter housing. See Figure 7.9.

NOTE: The small thrust washer goes on top of the rotor.

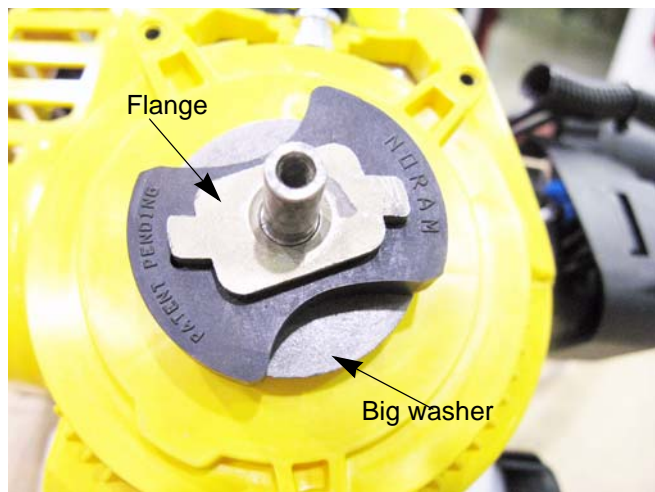

Figure 7.9

NOTE: The side of the rotor with the flange faces the clutch drum. See Figure 7.10.

- Torque the rotor to 210 - 230 in lbs (24 - 26 Nm).
- Slide the clutch drum onto the crankshaft and tighten it to a torque of 38-40 in. lbs.(4 - 5 Nm).
- Install the clutch housing and the drive shaft assembly following the steps mentioned earlier in reverse order.
- Test run the engine/trimmer before returning it to service.

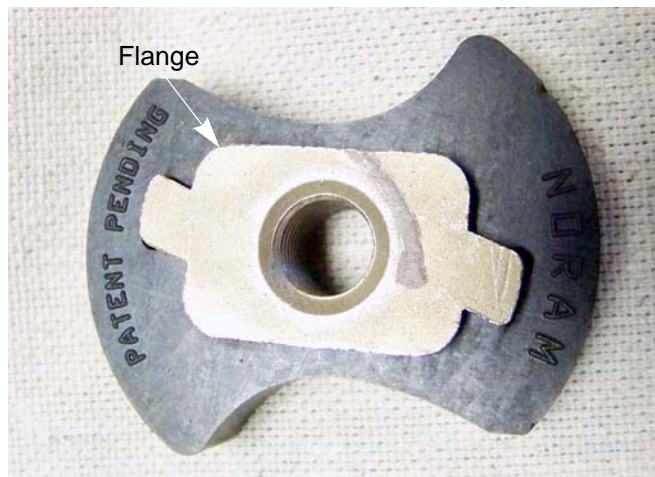

Figure 7.10

CHAPTER 8: ENGINE ASSEMBLY

Theory of operation

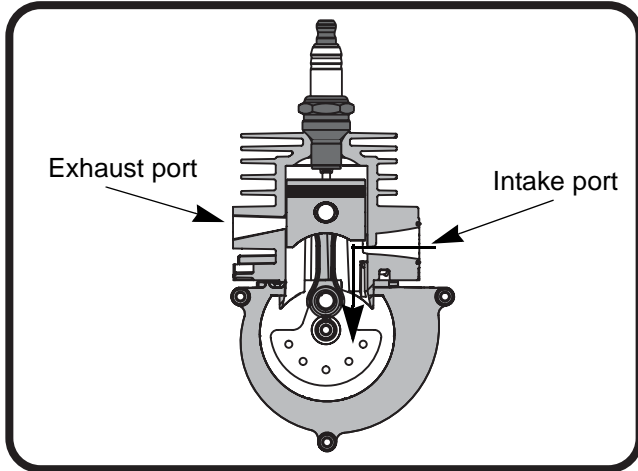

Figure 8.1

The P25 series of engines are piston ported engines. As the piston travels upward:

- The exhaust port is covered.
- The fuel/air mixture above the piston is compressed. See Figure 8.1.
- Fuel/air mix is drawn into the crankcase.
- The spark plug will fire just before the piston reaches top dead center, igniting the fuel/air mixture.

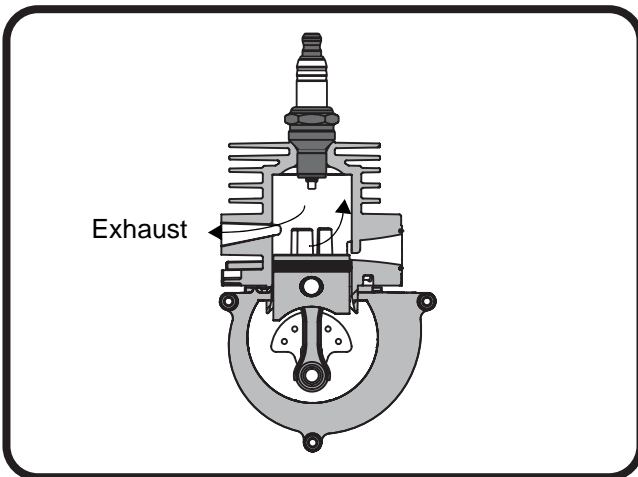

Figure 8.2

As the piston travels downward:

- The exhaust port is uncovered, allowing the burn gases to escape.
- The piston compresses the fuel/air mix in the crankcase, forcing the mixture up through transfer ports in the side of the cylinder.
- The fuel/air mixture enters the combustion chamber, flowing towards the intake side of the cylinder.

NOTE: This flow pattern helps to push the exhaust gases out of the cylinder.

P25 Series of Engines

Engine disassembly

Economics and parts availability will determine how much engine disassembly is feasible. There are two main levels of engine disassembly.

1. Short block installation.

Short block installation consists of removing the engine, transferring the external parts to the replacement short block, and installing the engine. External parts consist of:

- Starter
- Ignition system
- Fuel system
- Muffler

2. Complete tear down

A complete tear down may be done to re-seal the crankcase or for failure analysis.

NOTE: The only internal engine part available for service is the O-ring between the cylinder and the crankcase.

NOTE: The repair/replace choice in warrantable situations must be made using the 2/3 replacement cost rule. Outside of warranty, the decision is left to the dealer and the customer.

NOTE: There are a few different paths that can be followed when disassembling an engine. This chapter will cover the removal of components in one order, but it is written so that the technician can go to the component being removed.

1. Remove the Clutch by following the procedures described in Chapter 7: Clutch and Drive Shaft.
2. Remove the starter following the steps described in Chapter 6: Starter.
3. Remove the carburetor, insulator block and the fuel tank by following the procedures described in Chapter 5: Fuel System and Carburetor.
4. Remove the two screws that hold the engine cover to the engine using a T-25 torx driver. See Figure 8.3.



Figure 8.3

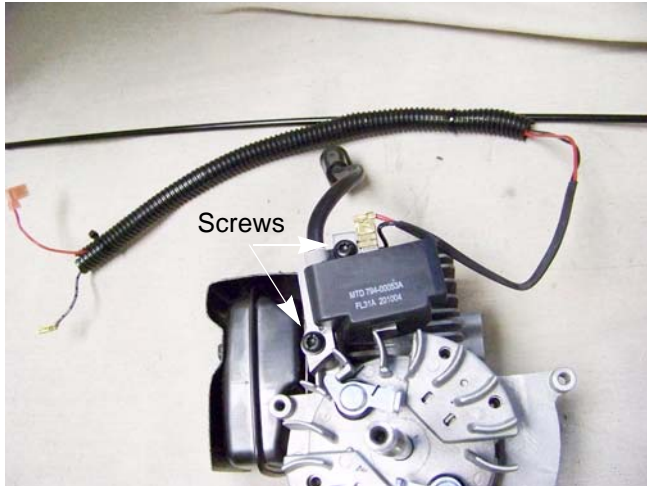

Figure 8.4

5. Rotate the flywheel so that the magnets are away from the module.
6. Remove the two screws that secure the ignition module to the block using a T-20 torx driver. See Figure 8.4.
7. Remove the module.

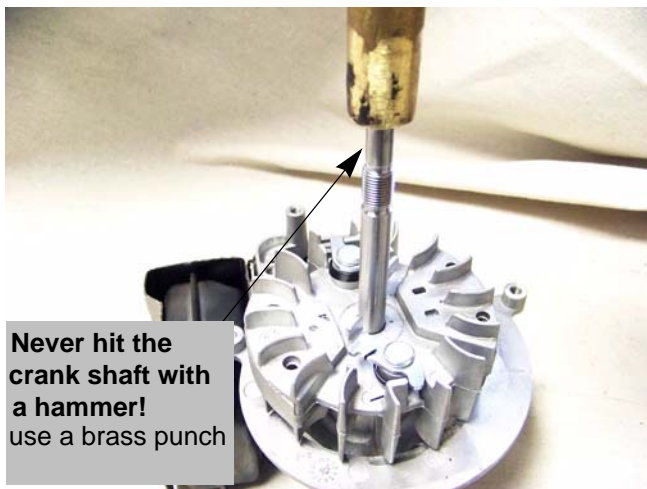

Figure 8.5

8. Remove the flywheel by applying a sharp blow to the crankshaft while gently prying upward with a pry bar. The flywheel will loosen then lift it off. See Figure 8.5.



Never strike the crankshaft directly with a hammer. To prevent damage to the crankshaft use a brass punch or a piece of wood between the hammer and the crankshaft.

NOTE: If replacing a short block, exchange the crankcase and cylinder with the short block and follow the previous steps in reverse order.



Figure 8.6

9. Remove the muffler using a T-27 torx driver or a 5/16" wrench. See Figure 8.6.

P25 Series of Engines

10. Remove the two cylinder bolts using a T-30 torx driver. See Figure 8.7.
11. Slide the cylinder off of the piston and connecting rod.
12. Remove the O-ring from the cylinder base.



Figure 8.7

NOTE: The following steps are shown only for the purpose of failure analysis.

13. Slide the connecting rod off of the crank pin.



Figure 8.8

14. Carefully remove the piston rings, keeping track of the original order and direction of installation.
15. Remove the cap from the wrist pin bore of the piston. See Figure 8.9.
16. Withdraw the wrist pin and remove the piston.

NOTE: If there has been metal transfer from the piston skirt to the cylinder wall, replace the short block.

17. Immediately reinstall the wrist pin in the small end of the connecting rod to prevent damage to the bearing. The wrist pin can be held in place temporarily using a hair pin clip.
18. Inspect the wrist pin, piston, connecting rod and the connecting rod bearing for signs of wear or damage.

NOTE: If there are any signs of wear or damage, short block the engine.

19. Clean the piston.

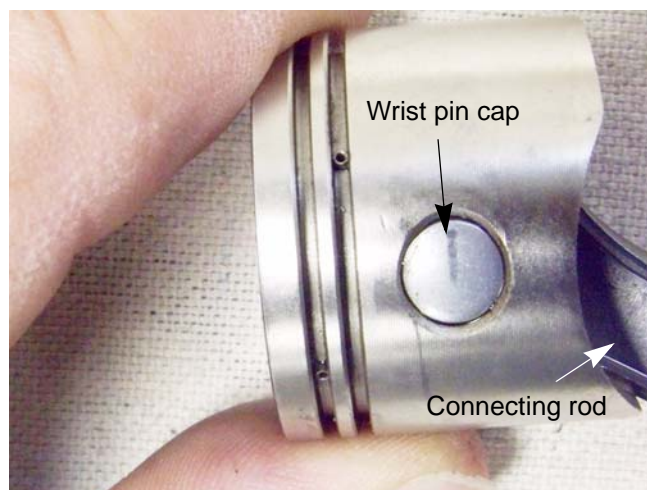

Figure 8.9

Engine Reassembly



Figure 8.10

1. Attach the piston to the connecting rod, if removed, by inserting the piston pin.

NOTE: The side of the connecting rod with the lettering on the bearing faces the side of the piston the cap is on. See Figure 8.10.

NOTE: The piston pin will only slide in from one side. After sliding the piston pin in, insert the piston pin cap.

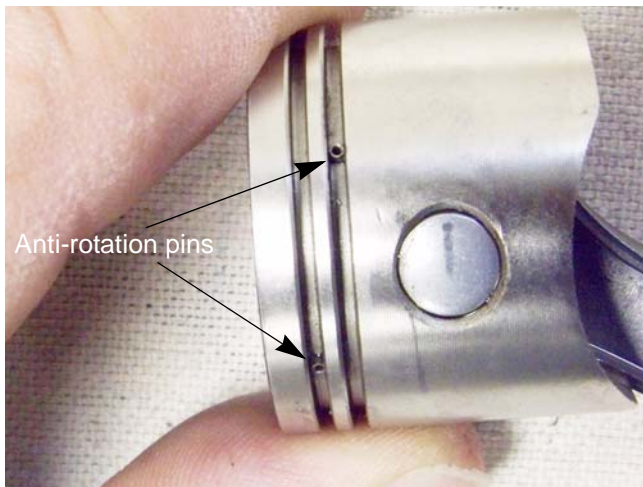

Figure 8.11

2. Install the piston rings on the piston.

NOTE: There is an anti-rotation pin in each piston ring groove to prevent the end of a ring from getting caught on a port. See Figure 8.11.

NOTE: When installing the piston rings, the ring gaps must line up with the pins.

NOTE: The piston rings are symmetrical.

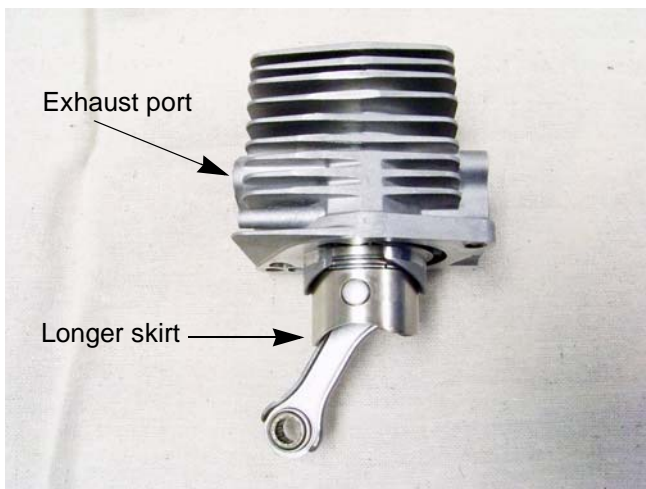

Figure 8.12

3. Lubricate the piston and cylinder wall with 10w30 motor oil.

4. Compress the piston rings and slide the cylinder over the piston just enough to cover the piston rings. See Figure 8.12.

NOTE: The side of the piston with the longer skirt face the exhaust side of the cylinder.

P25 Series of Engines

NOTE: Apply a coating of Slick 50® or similar product to the connecting rod bearing as a assembly lube.

5. Place the cylinder O-ring on the crankcase.
6. Slide the connecting rod onto the crankshaft pin.

NOTE: The lettering on the connecting rod bearing must face the crankshaft and the exhaust port must face the mounting arm of the ignition coil. See Figure 8.13.

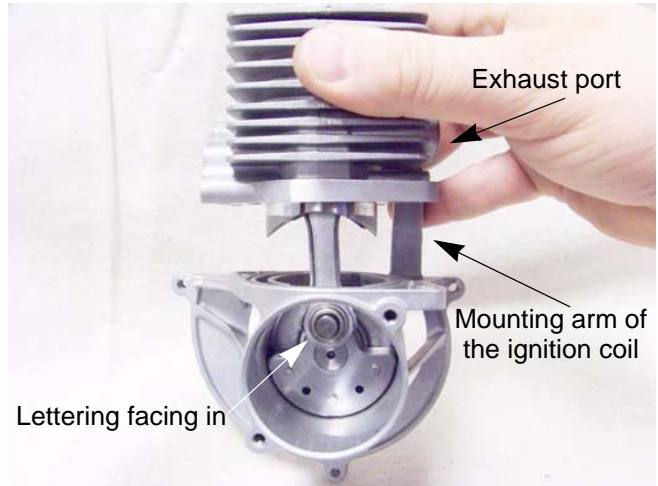

Figure 8.13

7. Apply a thread locking compound such as Loctite 266 to the cylinder bolts. Install the cylinder bolts using a T-30 torx driver and tighten them to a torque of 110 - 120 in lbs (12 - 14 Nm). See Figure 8.14.



Figure 8.14

8. Apply a light coat of oil to the O-ring on the engine cover. See Figure 8.15.
9. Install the engine cover and tighten the two screws to a torque of 30 - 40 in lbs (3 - 5 Nm).



Figure 8.15

10. Install the flywheel and module by following the procedures described in Chapter 4: Ignition.
11. Install the muffler.
NOTE: Apply a thread locking compound such as Loctite 266 to the muffler screws. Tighten the screws to a torque of 80 - 90 in. lbs (9 - 10 Nm).
12. Install the starter by following the procedures described in Chapter 6:Starter.
13. Install the carburetor spacer, the carburetor and the fuel tank by following the procedures described in Chapter 5: Fuel System and Carburetor.
14. Install the clutch, clutch housing and drive shaft assembly by following the procedures described in Chapter 7: Clutch and Drive Shaft.
15. Install the spark plug.
16. Test run the engine before returning it to service.

Torque Values

Torque Value	in lbs	Nm
Cylinder screws*	110 -120	12 - 14
Spark plug	160 - 220	18 - 25
Muffler screws*	80 - 90	9 - 10
Module screws	30 - 40	3 - 5
Clutch drum	38 - 40	4 - 5
Clutch rotor	210 - 230	24 - 26
Clutch housing screws	25 - 30	3
Carburetor screws	35 - 40	4 - 5
Insulator block screws*	45 - 50	5 - 6
Starter housing screws	30 - 40	3 - 5
Starter pressure plate	25 - 35	3 - 4
Fuel tank screws	17 - 23	2 - 3
Engine cover screws	30 - 40	3 - 5

* Apply a small amount of releasable thread locking compound such as Loctite® 242 (blue).

For Parts Call 606-678-9623 or 606-561-4983

P25 Series of Engines

For Parts Call 606-678-9623 or 606-561-4983

www.mymowerparts.com

For Parts Call 606-678-9623 or 606-561-4983

MTD Products Inc - Product Training and Education Department

FORM NUMBER - 769-06465

10/2010

www.mymowerparts.com