

Ref #	Part Number	Qty	S/P/F	Description
1	749-04292-0638	1	/P	Lower Handle Assembly
2	710-04605	1		Hex Screw, 5/16-18 x 1.50
3	710-0487	1	/P	Carriage Screw, 5/16-18 x 2.00
4	720-04072	1	S	Star Knob, 5/16-18
5	720-04091	1		Foam Grip, .970 x 25
6	781-04165-0638	1		Back Plate
7	936-0451	1	/P	Saddle Washer, .320 x .93 x .060
8	749-04291-0638	1		Upper Handle
9	734-04033	1	/P	Wheel, 8 x 2
10	734-04019	1		Wheel, 12"
11	712-04065	1	/P	Flange Lock Nut, 3/8 -16
12	726-0299	1	/P	Push Cap, 1/2"
13	936-0504	1	/P	Wave Washer, .510 x .750 x .017
14	738-0213	1	/P	Shoulder Screw, .498 x 1.445
15	781-04212-0637	1	/P	Guide Plate
16	710-04373A	1		Hex Screw, 12-16 x .75
17	731-05664	1		Blower Cover
18	631-04253	1		Chute Assembly
19	781-04175-0638	1		Chute Plate
20	631-04213	1		Impeler Assembly
21	712-1254	1		Hex Screw, 3/8 -24 x 2.25
22	936-0217	1	/P	Lock Washer, 3/8
23	731-05592	1		Blower Housing
24	681-04067-0638	1	S	Frame
25	710-0654A	1	/P	Sems Screw, 3/8 -16 x 1.000
26	712-04063	1	/P	Flange Lock Nut, 5/16-18
27	781-04181-0638	1		Lever Lever
28	710-0237	1	/P	Hex Bolt, 5/16-24 x .625
29	710-3008	1	/P	Hex Bolt, 5/16-18 x .75
30	712-04035	1		Hex Lock Nut, #8-32
31	712-04064	1	/P	Flange Lock Nut, 1/4-20
32	720-0426	1	/P	Height Adjustment Knob
33	731-05644	1		Louver Plate
34	932-3042	1		Comp. Spring, .515 x .641 x .95
35	736-0242	1	/P	Bell Washer, .340 x .872 x .060
36	738-04222	1		Shoulder Screw, .437 x .50 x 1/4-20
37	738-04223	1		Shoulder Screw, .18 x 4.8 x 8-32

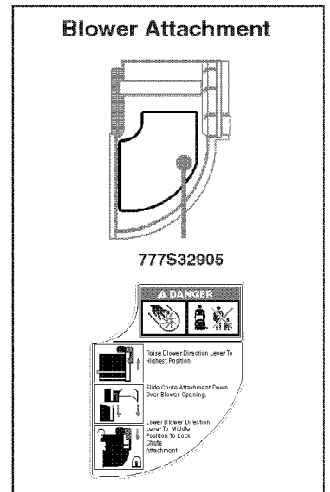
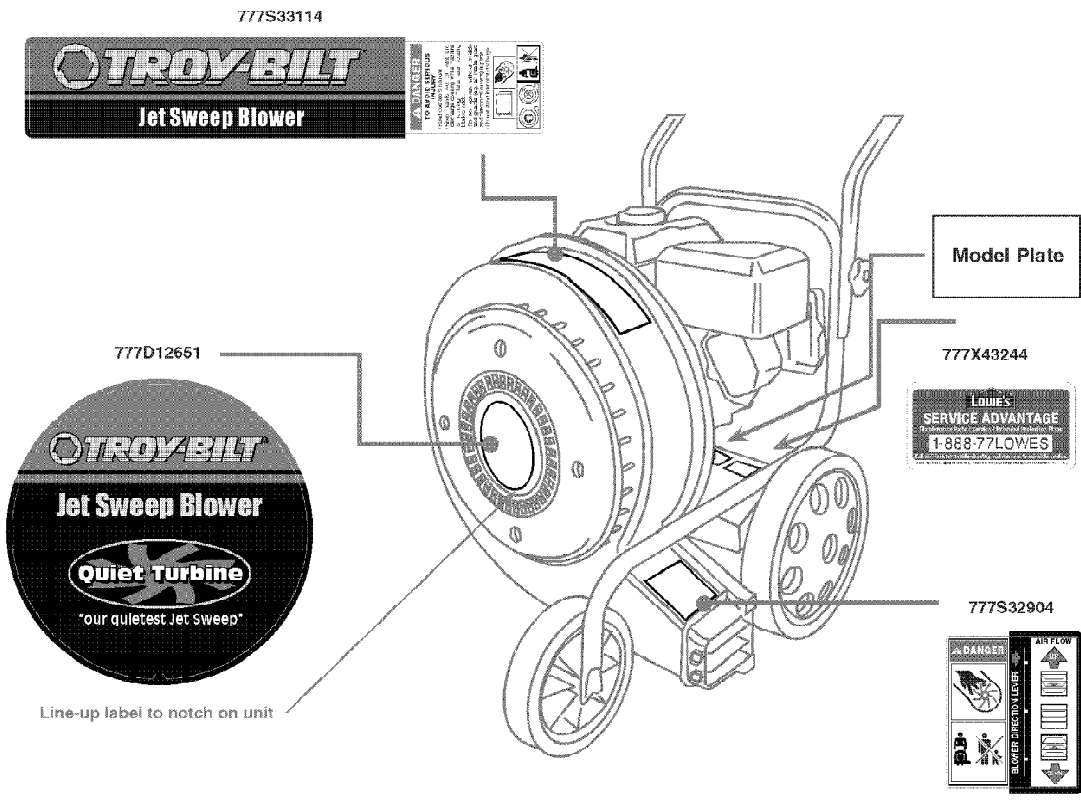

24A-672G066 Jet Sweep Blower (2009)
Label Map

Page 4 of 6

Ref #	Part Number	Qty	S/P/F	Description
777S33114	777S33114	1		LABEL-JETSWEP:TPBLWRHSG:DNGR
777D12651	777D12651	1		LABEL-JTSWP:FRNT:TBILT
777S32904	777S32904	1		LABEL-LOUVER LEVER JET SWEEP
777X43244	N/A	1		LABEL-LOWES:SERVICELBL
777S32905	777S32905	1		LABEL-BLOWER CHUTE

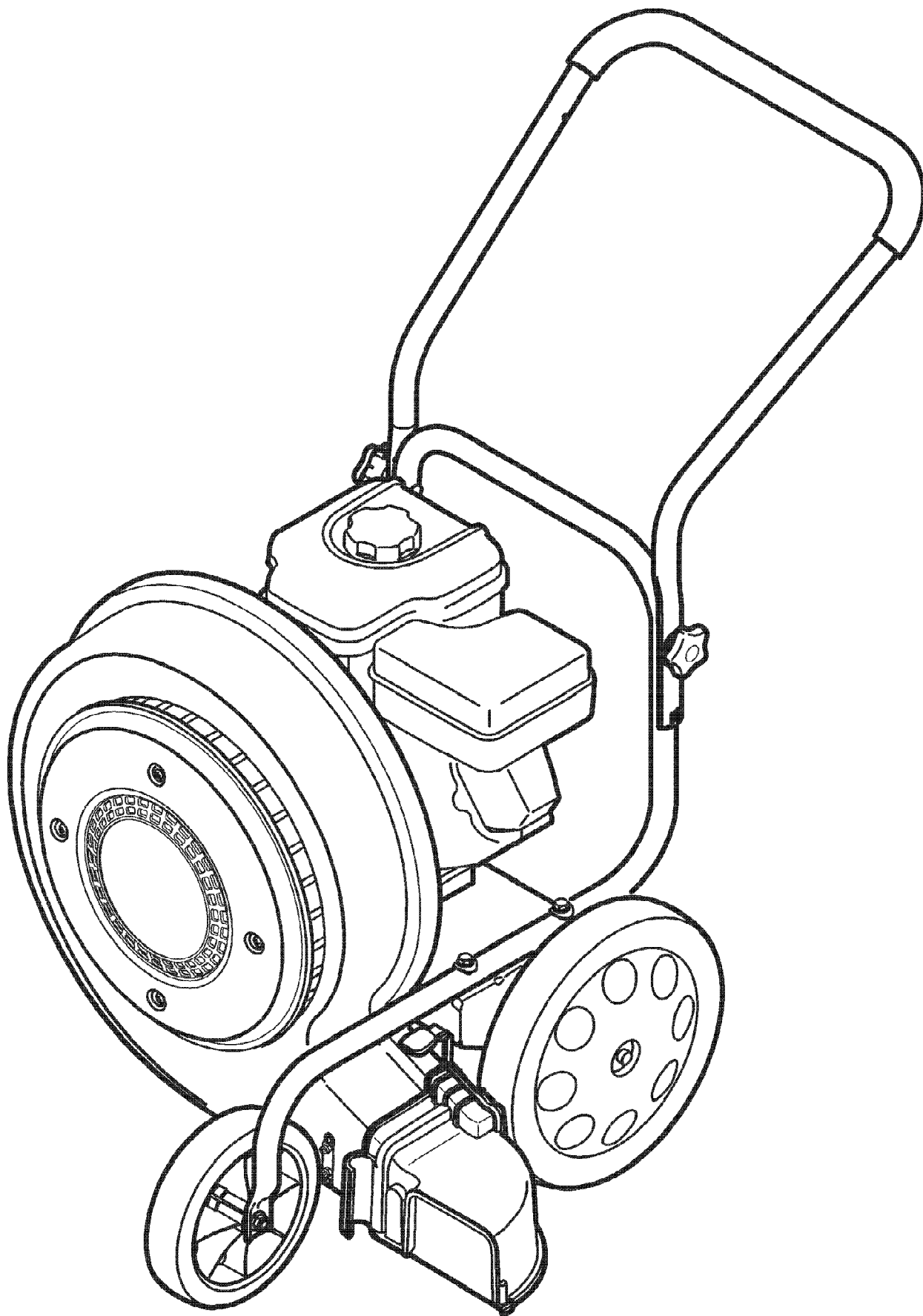

24A-672G066 Jet Sweep Blower (2009)
Quick Reference

Page 6 of 6

Ref #	Part Number	Qty	S/P/F	Description
	759-3336	1	/P	Spark Plug
	BS-493537S	1	/P	Pre Filter
	BS-491588S	1	/P	Air Filter
	BS-298090S	1	/P	Fuel Filter
	720-04091	1		Foam Grip
	720-0426	1	/P	Height Adjustment Knob
	720-04072	1	S	Handle Knob
	734-04019	1		Wheels
	734-04033	1	/P	Front Caster Wheel
	726-0299	1	/P	Push Cap (Wheel)