

ILLUSTRATION SHOWS TYPICAL PARTS ONLY. ORDER BY PART NUMBER. PARTS NOT LISTED ARE SUPPLIED BY OEM.



Ref #	Part Number	Qty	Description
1	34975		Cylinder Ass'y. (Incl. 2, 8, 9 & 20) (2-1/2")
2	26727		Pin, Dowel
6	33734		Element, Breather
7	34214A		Breather Ass'y. (Incl. 6, 8, 9, 12 & 12A)
8	33735		* Gasket, Breather
9	30200		Screw, 10-24 x 9/16"
12A	34695		Elbow, Breather tube
12	33886		Tube, Breather
14	28277		Washer
15	30589		Rod, Governor (Incl. 14)
16	31383A		Lever, Governor
17	31335		Clamp, Governor lever
18	650548		Screw, 8-32 x 5/16"
19	31361		Spring, Extension
20	32600		Seal, Oil
30	34441		Crankshaft Ass'y.
40	34514		Piston, Pin & Ring Set (Std.) (2-1/2" Bore)
40	34515		Piston, Pin & Ring Set (.010" OS)
40	34516		Piston, Pin & Ring Set (.020" OS)
41	32538B		Piston & Pin Ass'y. (Incl. 43)(Std.)( 2-1/2")
41	32548B		Piston & Pin Ass'y. (Incl. 43) (.010" OS)
41	32549B		Piston & Pin Ass'y. (Incl. 43) (.020" OS)
42	28986		Ring Set (Std.) (2-1/2" Bore)
42	28987		Ring Set (.010" OS)
42	28988		Ring Set (.020" OS)
43	20381		Ring, Piston pin retaining
45	30963B		Rod Assy., Connecting (Incl. 46)
46	32610A		Bolt, Connecting rod
48	27241		Lifter, Valve
50	33148A		Camshaft
52	29914		Oil Pump Assy.
69	35261		* Gasket, Mounting flange
70	35651B		Mounting Flange (Incl. 72, 72A, 73, 7 5 & 80)
72	30572		Plug, Oil drain (Incl. 73)
73	28833		* Drain Plug Gasket (Not req. W/plastic plug)
75	26208		Seal, Oil
80	30574		Shaft, Governor
81	30590A		Washer, Flat
82	30591		Gear Assy., Governor (Incl. 81)
83	30588A		Spool, Governor
84	29193		Ring, Retaining
86	650488		Screw, 1/4-20 x 1-1/4"
89	611004		Flywheel Key
90	611046A		Flywheel
92	650815		Washer, Belleville
93	650816		Nut, Flywheel
100	730207		Magneto-to-Solid State Conversion Kit (Includes solid state module, solid state flywheel key, and instructions.)(Use as required on external ignition engines only.)
100	34443A		Solid State Assy.
103	650814		Screw, Torx T-15, 10-24 x 1"
110	34231		Ground Wire
119	29953C		* Gasket, Cylinder head
120	34335		Head, Cylinder
125	29313C		Exhaust Valve (Std.) (Incl. 151)
125	29315C		Exhaust Valve (1/32" OS) (Incl. 151)
126	29314B		Intake Valve (Std.) (Incl. 151)

Ref #	Part Number	Qty	Description
126	29315C		Intake Valve (1/32" OS) (Incl. 151)
130	6021A		Screw, 5/16-18 x 1-1/2"
135	34251		Resistor Spark Plug (RJ17LM)
150	31672		Spring, Valve
151	31673		Cap, Lower valve spring
169	27234A		* Gasket, Valve spring box
172	32755		Cover, Valve spring box
174	650128		Screw, 10-24 x 1/2"
178	29752		Nut & Lockwasher, 1/4-28
179	30593		Clip, Magneto wire
182	6201		Screw, 1/4-28 x 7/8"
184	26756		* Gasket, Carburetor
185	31384A		Pipe, Intake (Incl. 224)
186	34337		Link, Governor spring
200	33970A		Control Bracket (Incl. 202 thru 206)
202	33802		Spring, Torsion
203	31342		Spring, Torsion
204	650549		Screw, 5-40 x 7/16"
205	650777		Screw, 6-32 x 21/32"
206	610973		Terminal (Use as required)
207	34336		Link, Throttle
209	30200		Screw, 10-24 x 9/16"
215	33971		Knob, Control
223	650451		Screw, 1/4-20 x 1"
224	34690A		* Gasket, Intake pipe
261	30200		Screw, 10-24 x 9/16"
262	650831		Screw, 1/4-20 x 15/32"
275	27181B		Muffler Kit (Incl. 274 & 277)
277	650795		Screw, 1/4-20 x 2-1/4"
290	30962		Fuel Line (Braided 32")(81cm)(Use as req.)
290	34357		Fuel Line (Epichlorohydrin 6-3/4") (1 7cm)
290	29774		Fuel Line (Braided 8-1/4")(21cm)(Use as req.)
290	30705		Fuel Line (Braided 16")(40cm)(Use as req.)
292	26460		Clamp, Fuel line
305	34264		Oil Fill Tube
306	34265		Gasket, Oil fill tube
306	34282		"O" Ring (This "O" ring is required with metal fill tube only when replacement mounting flange with .777 dia. oil fill hole has been used.)
307	33590		"O" Ring
309	650562		Screw, 10-32 x 1/2"
310	34267		Dipstick (Incl. 307)
313	34080		Spacer, Flywheel key
379	631021		Inlet Needle, Seat & Clip Assy.
380	632053		Carburetor (Incl. 184) (Refer to Division 5, Section A2-4, page 142 or Fiche 8, Grid E-13 for breakdown)
400	33238C		* Gasket Set (Incl. items marked *)
420	730225		SAE 30, 4-Cycle Engine Oil (Quart)

ILLUSTRATION SHOWS TYPICAL PARTS ONLY. ORDER BY PART NUMBER. PARTS NOT LISTED ARE SUPPLIED BY OEM.



Ref #	Part Number	Qty	Description
118	730194		Rope Guide Kit (Use as required with 34476 fuel tank)
246C	35705		Filter, Pre-Air (Optional)
260	34367		Housing, Blower
262	650831		Screw, 1/4-20 x 15/32"
287A	650735		Screw, 10-24 x 3/8" (Use as required)
287A			Pop Rivet, (3/16" Dia.)(Purchase locally)
287	650802		Screw, 1/4-20 x 5/8"
298	28763		Screw, 10-32 x 35/64"
300A	34369A		Fuel Tank (Incl. 292 & 301A) NOTE: These tanks (34369A) were built with different size fuel inlet openings. Tanks with the 1-3/16" I.D. opening use fuel cap 33032. Tanks with the 1-1/2" I.D. opening use fuel cap 35355.
301	33032		Fuel Cap
326	34113		Plug, Screen
350	34353		Primer Assy.
351	32180C		Line, Fuel primer
370A	34442A		Decal, Instruction
390	590531		Side Mount Rewind Starter (Refer to Division 5, Section C, page 32 or Fiche 8, Grid G-8 for breakdown)

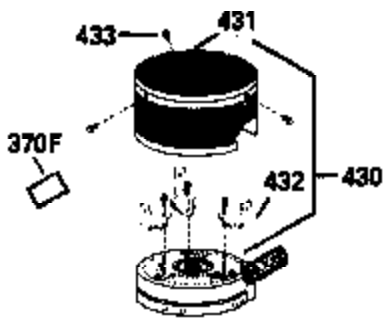

Ref #	Part Number	Qty	Description
274	26754A		* Gasket, Exhaust (Use as required)
277	650795		Screw, 1/4-20 x 2-1/4"
277A	30063		Screw, 1/4-20 x 1/2" (Use as required )
370F	34387		Decal, Instruction (Optional)
415	730162		Muffler Adap.Kit(Incl.274,277A)(Use a s req.)
430	730574		Debris Screen Kit (Incl. 370F,431-433 )(Opt.)
431	35596		Screen, Debris (Optional)
432	35597		Bracket, Debris screen (Optional)
433	650910		Screw, 8-32 x 1/4" (Optional)





Ref #	Part Number	Qty	Description
19	31361		Spring, Extension
69	35261		* Gasket, Mounting flange
182	6201		Screw, 1/4-28 x 7/8"
185	31384A		Pipe, Intake (Incl. 224)
186	34337		Link, Governor spring
209	30200		Screw, 10-24 x 9/16"
223	650451		Screw, 1/4-20 x 1"
245A	32972		Filter, Air cleaner
246B	35435		Filter, Pre-Air (Use as required)
247	33168		Clamp, Corbin
255	34371		Cover, Speed control
256	650807		Screw, 10-32 x 7/16"