

ILLUSTRATION SHOWS TYPICAL PARTS ONLY. ORDER BY PART NUMBER. PARTS NOT LISTED ARE SUPPLIED BY OEM.



## Engine Parts List #1

Ref #	Part Number	Qty	Description
1	34348B		Cylinder (Incl.2,20,72,72A) (3-1/8" B ore)
2	27652		Pin, Dowel
15	30699C		Rod Assy., Governor (Incl. 15A & 15B)
15A	30700		Yoke, Governor
15B	650494		Screw, 6-40 x 5/16"
16	33454		Governor Lever Assy.
17	29916		Clamp, Governor lever
18	650548		Screw, 8-32 x 5/16"
19	33578		Spring, Governor
20	32630		Seal, Oil
25	35256A		Baffle, Blower housing
26	650561		Screw, 1/4-20 x 5/8"
30	33720B		Crankshaft (Incl. 108 & 109)
32	33628		Washer, Thrust
35	29826		Screw, 10-32 x 3/4"
36	29918		Lockwasher, # 8 E.T.
37A	30322		Locknut, Hex "Keps", 8-32
37	29216		Nut & Lockwasher, 10-32 "Keps"
38	29642		Ring, Retaining
40	34552		Piston, Pin & Ring Set (Std.) (3-1/8" )
40	34553		Piston, Pin & Ring Set (.010" OS)
40	34554		Piston, Pin & Ring Set (.020" OS)
41	34329A		Piston & Pin Ass'y.(Std)(Incl.43)(3-1 /8")
41	34330A		Piston & Pin Ass'y. (.010" OS)(Incl. 43)
41	34331A		Piston & Pin Ass'y. (.020" OS)(Incl. 43)
42	34332		Ring Set (Std.) (3-1/8" Bore)
42	34333		Ring Set (.010" OS)
42	34334		Ring Set (.020" OS)
43	27888		Ring, Piston pin retaining
45	32591C		Rod Assy., Connecting (Incl. 49)
47	650662C		Bolt, Connecting rod (2 pieces)
48	34034		Lifter, Valve
49	34242		Dipper, Oil
50	34143		Camshaft (MCR)
60	33273A		Extension, Blower housing
65	650128		Screw, 10-24 x 1/2"
69	35262		* Gasket, Cylinder cover
70	33626B		Cyl. Cover (Incl.71,74,75,80,175,176, 311,312)
72	27642		Plug, Oil drain
75	33625		Seal, Oil
80	31845		Shaft, Mechanical governor
81	30590A		Washer, Flat
82	30591		Gear Assy., Governor (Incl. 81)
83	30588A		Spool, Governor
84	29193		Ring, Retaining
86	650833		Screw, 1/4-20 x 1-3/16"
87	650832		Screw, 1/4-20 x 1-11/16"
89	32589		Key, Flywheel
92	650815		Washer, Belleville
93	8116		Nut, Hex (1/2-20)
101	610118		Cover, Spark plug (Use as required)
103	650489		Screw, 1/4-20 x 5/8"
108	29783		Pin, Crankshaft gear
109	33245		Gear, Crankshaft
119	34041A		* Gasket, Head
120	34030A		Head, Cylinder
125	27878A		Exhaust Valve (Std.) (Incl. 151)
125	27880A		Exhaust Valve (1/32" OS) (Incl. 151)

Ref #	Part Number	Qty	Description
126	34035		Intake Valve (Std.) (Incl. 151)
126	34036		Intake Valve (1/32" OS) (Incl. 151)
127A	26073		Washer, Flat (Use as required)
127A	650570		Washer, Flat (Use as required)
127	650691		Washer (Use as req., but not w/6021A screw)
128	650690		Washer, Belleville
129	650727		Screw, 5/16-18 x 1-3/4" (Use as required)
130	650694A		Screw, 5/16-18 x 2" (Use as required)
130A	6021A		Screw, 5/16-18 x 1-1/2" (Use as required, but do not use with 650691 washer)
131	650802		Screw, 1/4-20 x 5/8" (Use as required)
131	650737		Screw, 1/4-20 x 1/2" (Use as required)
131	650738		Screw, 1/4-20 x 5/8" (Use as required)
131A	650713		Screw, 5/16-18 x 5/8" (Use as required)
131A	792028		Screw, 5/16-18 x 7/8" (Use as required)
135	33636		Resistor Spark Plug (RJ17LM)
139	33369		Bracket, Governor gear
140	650836		Screw, 10-24 x 1/2"
149	27882		Cap, Upper valve spring
149A	27882		Cap, Upper valve spring
150	27881		Spring, Valve
151	32581		Cap, Lower valve spring
169	27896A		* Gasket, Breather cover
170	28423		Body, Breather
171	28424		Element, Breather
172	28425		Cover, Valve spring
173	35350		Tube, Breather
174	650128		Screw, 10-24 x 1/2"
174	650597		Screw, 10-24 x 5/8"
178	29752		Nut & Lockwasher, 1/4-28
179B	30593		Clip, Primer line (Use as required)
182	30088A		Screw, 1/4-28 x 1"
184	33263		* Gasket, Carburetor
185	33877		Pipe, Intake
203	32924		Spring, Compression
204	650688		Screw, 10-32 x 1"
206	610973		Terminal Assy. (Use as required)
210	27793		Clip, Conduit
211	28942		Screw, 10-32 x 3/8"
223	650378		Screw, Torx T-30, 5/16-18 x 1-1/8"
224	27915A		* Gasket, Intake pipe
260	33375D		Blower Housing (For electric starter)
261	650788		Screw, 5/16-18 x 3/4" (Use as required)
262	29747B		Screw, 5/16-24 x 21/32"
265	33272B		Cover, Cylinder head
275	33280A		Muffler
275C	35824		Muffler (Optional quiet muffler)
276	31588		Plate, Muffler locking
277	650729		Screw, 5/16-18 x 3-3/16"
277A	650696		Screw, 5/16-18x2-3/4" (Used with 276A)
281	33013		Cover, Starter bubble
282	650760		Screw, 8-32 x 3/8"
286B	33662		Hub & Screen Assy., Starter
287	29752		Nut & Lockwasher, 1/4-28
290	29774		Fuel Line (Braided 8-1/4")(21 cm)(As req.)
290	30705		Fuel Line (Braided 16")(41 cm)(Use as req.)
290	30962		Fuel Line (Braided 32")(81 cm)(Use as req.)

Ref #	Part Number	Qty	Description
292	26460		Clamp, Fuel line (Use as required)
298	650665		Screw, 1/4-15 x 7/8"
300	34156A		Fuel Tank (Incl. 292 & 301) NOTE: These tanks were built with different size fuel inlet openings. Tanks with the 1-3/16" I.D. opening use fuel cap 34210. Tanks with the 1-1/2" I.D. opening use fuel cap 35355.
301	410144B		Fuel Cap (White Plastic)(Std)(1-1/2" I.D.)
301	33032		Fuel Cap (Red Plastic) (Spurt Resistant, Low Profile) (1-3/16" I.D.)
301	34210		Fuel Cap (Red Plastic) (Spurt Resistant, High Profile) (1-3/16" I.D.)
301	35355		Fuel Cap (Red plastic) (1-1/2" I.D.)
305	33893A		Tube, Oil fill
306	33590		"O" Ring
310	34011A		Dipstick (Incl. 306)
325	29443		Clip, Fuel line (Use as required)
325	34246		Clip, Ground wire (Use as required)
340	34154		Plate, Fuel tank mounting
341	34155		Bracket, Fuel tank mounting
342	650561		Screw, 1/4-20 x 5/8"
370J	34870		Decal, Instruction Can be used on HM80 with diecast starter.
370	34346		Decal, Instruction
370A	550223		Decal, Name
379	631021		Inlet Needle, Seat & Clip Assy.
380	631979		Carburetor (Incl. 184) (Refer to Division 5, Section A, page 150 for breakdown or Fiche 18A-1, Grid E-7)
390	590479		Rewind Starter (Refer to Division 5, Section C, page 30 for breakdown or Fiche 18A-1, Grid G-5)
400	33279G		Gasket Set (Incl. items marked*)
408	35570		Screen Seal (Can be used on HM80 with stamped steel recoil starter)
409	35569		Spacer (Can be used on HM80 with stamped steel recoil starter)
410	730573		Debris Screen Kit (Incl. 360, 370B, 387, 411 & 413) (Can be used on HM80 with stamped steel recoil starter)
411	35568		Debris Screen (Can be used on HM80 with stamped steel recoil starter)
413	650907		Screw, 5/16-18 x 1-5/8" (Can be used on HM80 with stamped steel recoil starter)
420	730225		SAE 30, 4-Cycle Engine Oil (Quart)
421	730226		SAE 5W30, 4-Cycle Engine Oil (Quart)
425	730572		Starter Muff Kit (Incl. 370J, 426 & 4 27) (Can be used on HM80 with die cast starter)
429	650868		Screw, 8-18 x 1-1/8" (3 Required) (Use as required) (Refer to Mechanics Handbook for installation instructions).
430	611077		Alternator, Add on (Use as required) (Refer to Mechanics Handbook for installation instructions).
431	590609		Centering tube (Use with engines equipped with die cast aluminum starter)(Use as required) (Refer to Mechanics Handbook for installation instructions)

Ref #	Part Number	Qty	Description
431	590610		Centering tube (Use as required) (Refer to Mechanics Handbook for installation instructions).
432	611078		A.C. Lighting Connector (Use as required) (Refer to Mechanics Handbook for installation instructions).
432	611079		D.C. Charging Connector (Use as required) (Refer to Mechanics Handbook for installation instructions).
433	590611		Alternator Shaft (4.00") (Use with engines equipped with cast aluminum starter)(Use as required) (Refer to Mechanics Handbook for installation instructions).
433	590636		Alternator Shaft (Use with engines equipped with stamped steel starter)(Use as required) (Refer to Mechanics Handbook for installation instructions).

ILLUSTRATION SHOWS TYPICAL PARTS ONLY. ORDER BY PART NUMBER. PARTS NOT LISTED ARE SUPPLIED BY OEM.

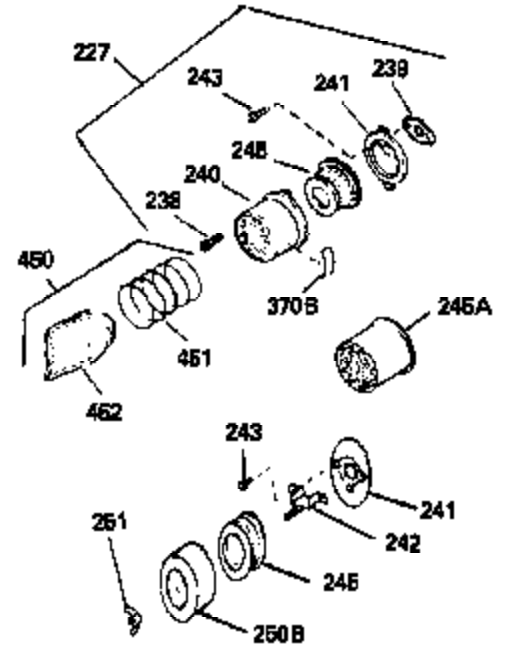
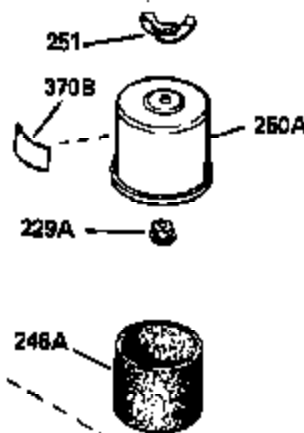
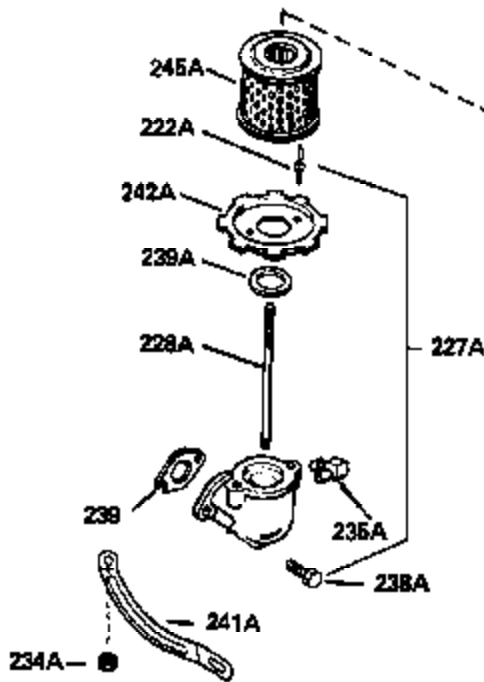
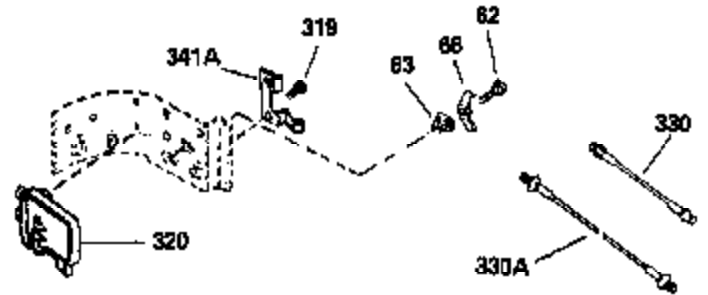
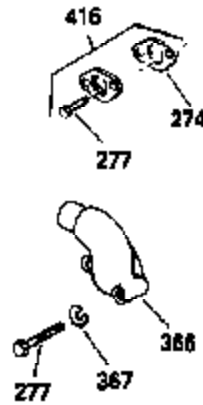
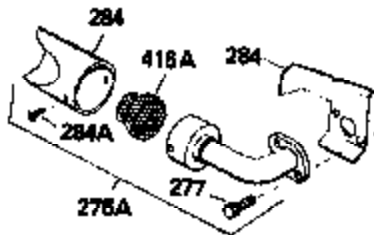
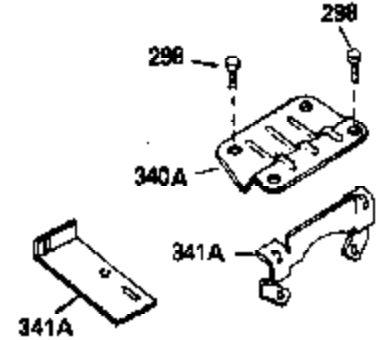
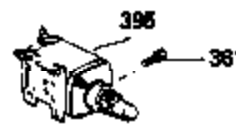
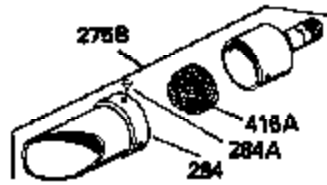
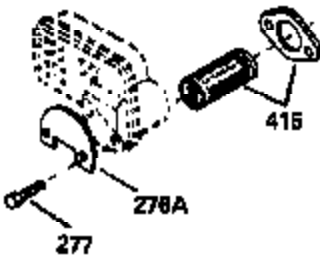
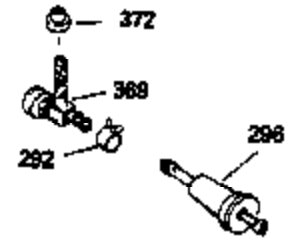
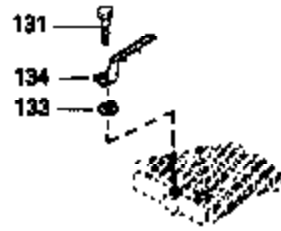
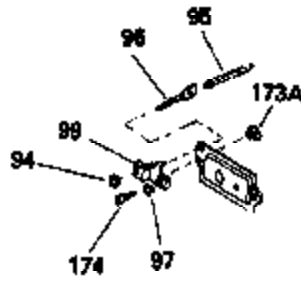
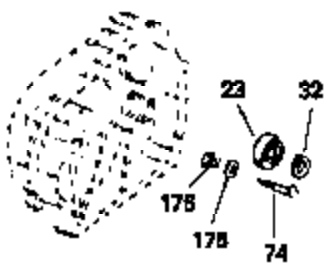

Ref #	Part Number	Qty	Description
23	33627		Bearing, Ball
32	33628		Washer, Thrust
74	31855		Retainer, Bearing
97			Lockwasher, Heavy split, #10 (Buy locally)
131	650802		Screw, 1/4-20 x 5/8" (Use as required)
131	650737		Screw, 1/4-20 x 1/2" (Use as required)
131	650738		Screw, 1/4-20 x 5/8" (Use as required)
133	650890		Washer, Lock, 5/16"
134	30747		Clip, Spark plug shorting
174	650128		Screw, 10-24 x 1/2"
174	650597		Screw, 10-24 x 5/8"
175	650778		Lockwasher
176	650580		Nut, Lock, 10-24
227	730127		Air Cleaner Ass'y. (Incl.238,239,240,241,243,245 & 370) (Use as required)
227	730164		Air Cleaner Ass'y. (Incl. 238, 239, 240, 241, 243 & 245) (Use as required)
228A	650824		Stud, 1/4-20 x 7.33 (Use as required)
228A	650851		Stud, 1/4-20 x 8.1 (Use as required) (Used with drilled thru elbow)
239	27272A		* Gasket, Air cleaner
239	27272A		* Gasket, Air cleaner
241	33266		Bracket, Air cleaner
242	33267		Bracket, Air cleaner
243	28820		Screw, 10-32 x 1/2"
245A	34700		Element, Air cleaner
245	33268		Element, Air cleaner
250B	33269A		Cover, Air cleaner
251	650513		Nut, Wing, 1/2-20
274	35865		Gasket, Exhaust (Use as required)
275C	35824		Muffler (Optional quiet muffler)
275B	391026		Muffler (Incl. 284, 284A & 416A) (This spark arresting muffler can be used on any model.)
277A	650696		Screw, 5/16-18x2-3/4" (Used with 276A)
277	650729		Screw, 5/16-18 x 3-3/16"
292	26460		Clamp, Fuel line (Use as required)
298	650665		Screw, 1/4-15 x 7/8"
369	35857		Valve, Fuel shut-off
370J	34870		Decal, Instruction Can be used on HM80 with diecast starter.
370B	34387		Decal, Instruction Can be used on HM80 with stamped steel recoil starter.
395	33329D		Starter Motor Kit (110-120 Volt) This 110-120 volt starter motor kit may have been added to this engine. It can be added only if cylinder has drilled and tapped starter mounting bosses and a ring gear flywheel. Refer to service number stamped on end cap of motor, or on decal for identification. Ref
408	35570		Screen Seal (Can be used on HM80 with stamped steel recoil starter)
409	35569		Spacer (Can be used on HM80 with stamped steel recoil starter)
410	730573		Debris Screen Kit (Incl. 360, 370B, 387, 411 & 413) (Can be used on HM80 with stamped steel recoil starter)

Ref #	Part Number	Qty	Description
411	35568		Debris Screen (Can be used on HM80 with stamped steel recoil starter)
413	650907		Screw, 5/16-18 x 1-5/8" (Can be used on HM80 with stamped steel recoil starter)
415	730130		Exh.Adapter Kit (Incl.274,277)(Use as req.)
425	730572		Starter Muff Kit (Incl. 370J, 426 & 4 27) (Can be used on HM80 with die cast starter)
429	650868		Screw, 8-18 x 1-1/8" (3 Required) (Use as required) (Refer to Mechanics Handbook for installation instructions).
430	611077		Alternator, Add on (Use as required) (Refer to Mechanics Handbook for installation instructions).
431	590609		Centering tube (Use with engines equipped with die cast aluminum starter)(Use as required) (Refer to Mechanics Handbook for installation instructions)
431	590610		Centering tube (Use as required) (Refer to Mechanics Handbook for installation instructions).
432	611078		A.C. Lighting Connector (Use as required) (Refer to Mechanics Handbook for installation instructions).
432	611079		D.C. Charging Connector (Use as required) (Refer to Mechanics Handbook for installation instructions).
433	590611		Alternator Shaft (4.00") (Use with engines equipped with cast aluminum starter)(Use as required) (Refer to Mechanics Handbook for installation instructions).
433	590636		Alternator Shaft (Use with engines equipped with stamped steel starter)(Use as required) (Refer to Mechanics Handbook for installation instructions).



ILLUSTRATION SHOWS TYPICAL PARTS ONLY. ORDER BY PART NUMBER. PARTS NOT LISTED ARE SUPPLIED BY OEM.

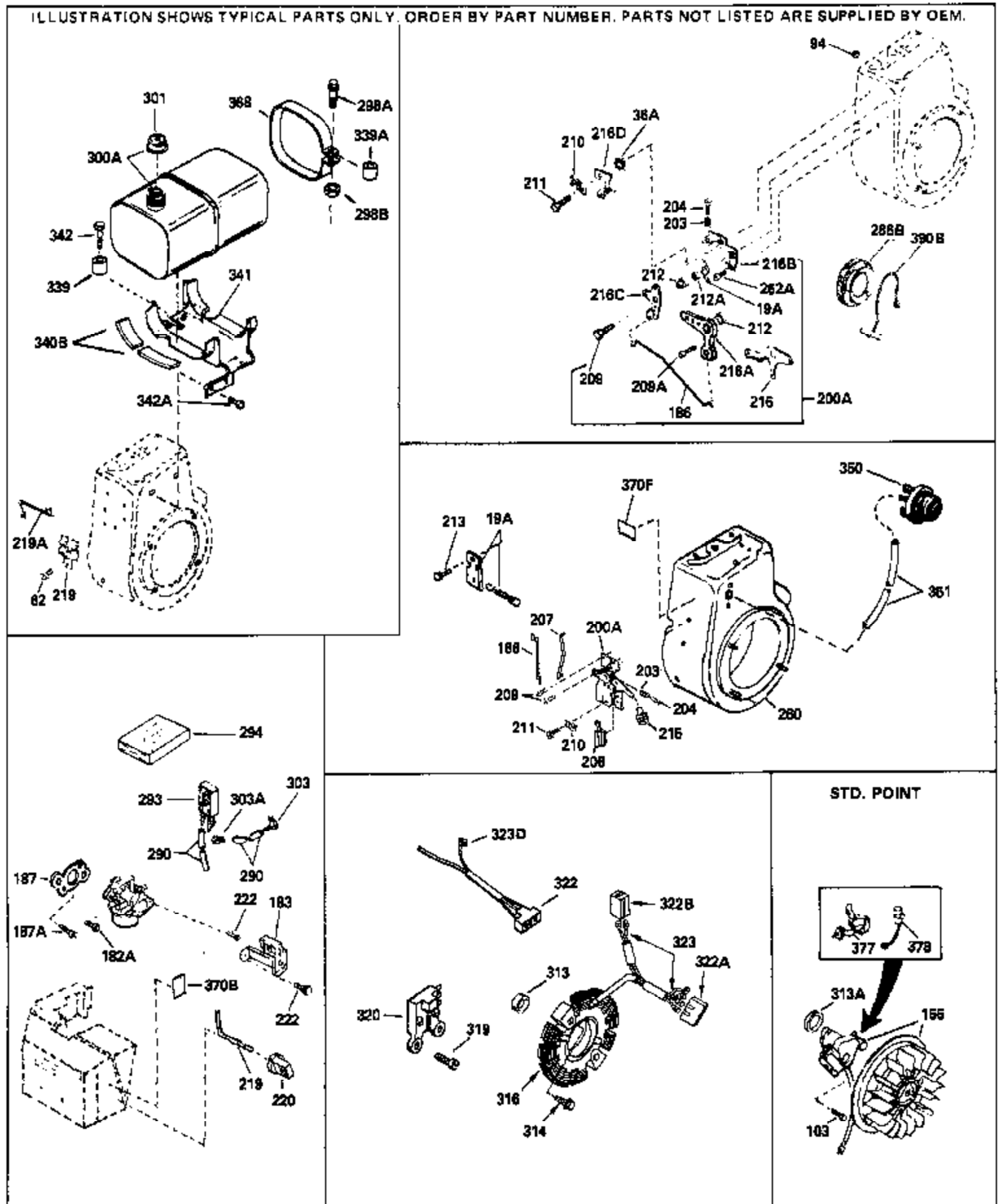

Ref #	Part Number	Qty	Description
103	650489		Screw, 1/4-20 x 5/8"
156	610842		Magneto (Incl. 377 & 378) NOTE: The complete magneto is not available as an assembly. The magneto number is shown for reference purposes only. Order component parts individually, as shown in parts list. (Refer to Division 5, Section B, page 28 for breakdown or Fiche 18A-1, Grid G-1)
186	33372		Link, Governor lever-to-bellcrank
200A	730152		Control Bracket (Incl. 19, 19A, 209A, 212, 212A, 216A, 216B, 216C & 262A)
203	32924		Spring, Compression
204	650688		Screw, 10-32 x 1"
206	610973		Terminal Assy. (Use as required)
207	33878		Link, Governor-to-throttle
209A	30312		Screw, 10-32 x 1/2"
210	27793		Clip, Conduit
211	28942		Screw, 10-32 x 3/8"
212A	28562		Bushing, R..M. adjusting lever
212	29530		Bushing, Bellcrank lever
216C	30201A		Lever, Speed control
216B	30199A		Bracket, Speed adjusting (Incl.100 & 324)
216A	30712		Lever, Bellcrank
260	33375D		Blower Housing (For electric starter)
262A	650399		Screw, 10-32 x 5/8"
275C	35824		Muffler (Optional quiet muffler)
277A	650696		Screw, 5/16-18x2-3/4" (Used with 276A )
286B	33662		Hub & Screen Assy., Starter
290	29774		Fuel Line (Braided 8-1/4")(21 cm)(As req.)
290	30705		Fuel Line (Braided 16")(41 cm)(Use as req.)
290	30962		Fuel Line (Braided 32")(81 cm)(Use as req.)
301	410144B		Fuel Cap (White Plastic)(Std)(1-1/2" I.D.)
301	33032		Fuel Cap (Red Plastic) (Spurt Resistant, Low Profile) (1-3/16" I.D.)
301	34210		Fuel Cap (Red Plastic) (Spurt Resistant, High Profile) (1-3/16" I.D.)
301	35355		Fuel Cap (Red plastic) (1-1/2" I.D.)
313A	33876		Gasket, Stator
339	35038		Spacer, Tank
341	34155		Bracket, Fuel tank mounting
342	650561		Screw, 1/4-20 x 5/8"
370B	34387		Decal, Instruction Can be used on HM80 with stamped steel recoil starter.
370J	34870		Decal, Instruction Can be used on HM80 with diecast starter.
377	30547A		Contact Assy., Breaker
378	30548B		Condenser
408	35570		Screen Seal (Can be used on HM80 with stamped steel recoil starter)
409	35569		Spacer (Can be used on HM80 with stamped steel recoil starter)
410	730573		Debris Screen Kit (Incl. 360, 370B, 387, 411 &413) (Can be used on HM80 with stamped steel recoil starter)
411	35568		Debris Screen (Can be used on HM80 with stamped steel recoil starter)

Ref #	Part Number	Qty	Description
413	650907		Screw, 5/16-18 x 1-5/8" (Can be used on HM80 with stamped steel recoil starter)
425	730572		Starter Muff Kit (Incl. 370J, 426 & 4 27) (Can be used on HM80 with die cast starter)
429	650868		Screw, 8-18 x 1-1/8" (3 Required) (Use as required) (Refer to Mechanics Handbook for installation instructions).
430	611077		Alternator, Add on (Use as required) (Refer to Mechanics Handbook for installation instructions).
431	590609		Centering tube (Use with engines equipped with die cast aluminum starter)(Use as required) (Refer to Mechanics Handbook for installation instructions)
431	590610		Centering tube (Use as required) (Refer to Mechanics Handbook for installation instructions).
432	611078		A.C. Lighting Connector (Use as required) (Refer to Mechanics Handbook for installation instructions).
432	611079		D.C. Charging Connector (Use as required) (Refer to Mechanics Handbook for installation instructions).
433	590611		Alternator Shaft (4.00") (Use with engines equipped with cast aluminum starter)(Use as required) (Refer to Mechanics Handbook for installation instructions).
433	590636		Alternator Shaft (Use with engines equipped with stamped steel starter)(Use as required) (Refer to Mechanics Handbook for installation instructions).