

**0-2202 22" Red Rotary Mower**

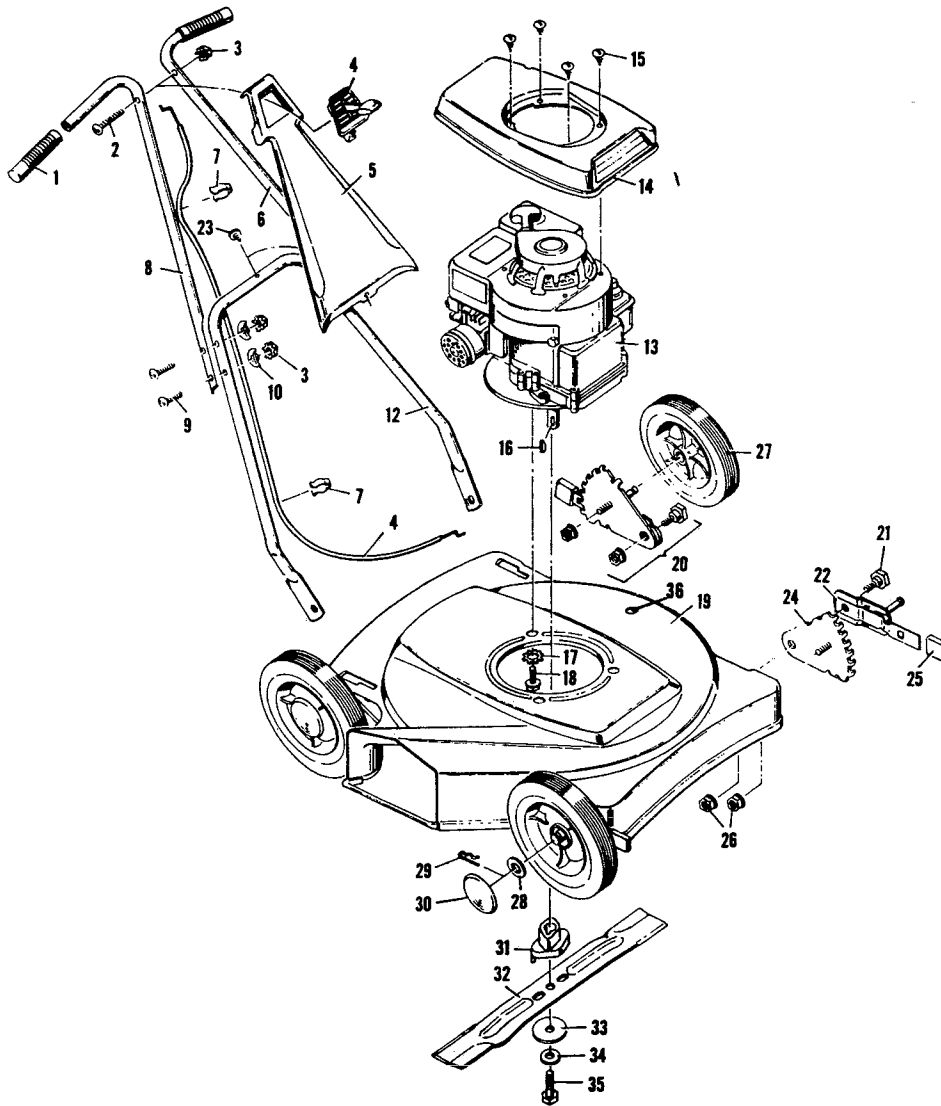

ITEM NO.	MODEL NO. 0-2202 PART NO.	DESCRIPTION	LIST PRICE EACH	ITEM NO.	MODEL NO. 0-2202 PART NO.	DESCRIPTION	LIST PRICE EACH
1	20140	Grip (2)	.60	18	20103	Engine Bolt (3)	.33
2	3x137	Screw	.20	19	20030E	Housing Assy.	22.93
3	15x66	Lock Nut (5)	.25	20	20088	Wheel Adjustor Assy. (4)	2.63
4	20230	Control Assy.	2.70	21	20064	Shoulder Bolt (4)	.30
5	20015E	Trim Panel	1.48	22	20109Z	Arm, Axle & Spring Assy. (4)	1.16
6	20061C	Upper Handle L. H.	1.79	23	26x11	Screw	.20
7	20089	Cable Clip (2)	.26	24	20113Z	Index Plate Assy. (4)	1.02
8	20060C	Upper Handle R. H.	1.79	25	20065	Lever Spring Knob (4)	.28
9	3x136	Screw (4)	.20	26	15x68	Flange Locknut (8)	.20
10	20087	Formed Washer (4)	.20	27	20104	Wheel & Tire (4)	3.78
12	20056C	Lower Handle	2.74	28	17x102Z	Washer (4)	.20
13	Engine	Briggs & Stratton 92908-1045-01 Repair & Replacement at Briggs & Stratton Service Center		29	20101	Hair Pin Cotter (4)	.20
14	20183E	Engine Shroud	3.20	30	20090	Hub Cap (4)	.55
15	26x159	Screw (4)	.20	31	20050	Blade Adapter	2.33
16	20062	Woodruff Key	.25	32	20046E	Blade	4.13
17	19x8	Shakeproof Washer (3)	.20	33	20094Z	Washer	.22
				34	17x101	Cup Washer	.41
				35	1x68	Adapter Bolt	.20
				36	20737	Plug Button	.20