

240 Super Chain Saw UT-10718-B
Carburetor Chamber/Rear Handle

Page 2 of 14

Ref #	Part Number	Qty	S/P/F	Description
1	A03151	1	/P	HANDGUARD w/Cover
2	95217	1		SCREW-Retaining
3	02661	1		DECAL-Warning
4	03128	1		DECAL-Warning
5	95089	1		AIR FILTER COVER (UT10713, A; UT10715-A, B, C; UT10635-D)
6	95211	1		COVER-Handle
7	82563	1	/P	SCREW-Thread Form. (10-24 X 3/4")
8	95038	1		INTERLOCK-Trigger
9	95222	1		SPRING-Torsion
10	95032	1		TRIGGER-Throttle
11	95036	1		ROD-Throttle
12	A96538A	1	/P	OIL PUMP-Complete
13	82312	1	/P	SCREW-Plastite (10 X 5/8")
14	93426	1	/P	CLAMP (Oil Outlet Line)
15	0745418	1		TUBING-Rubber (4 1/2")
16	0745425	1		TUBING-Rubber (6 1/4")
17	A954851	1		CARBURETOR CHAMBER
18	70810	4	S	NUT-Square
19	95337	2		RETAINER NOT
20	95375	2		RETAINER NUT
?21	96818	1	/P	SCREW-Socket Hd. (10-24 X 1 5/8")
22	A06391	1		VIBRATION ISOLATOR KIT (See "Engine Housing - Clutch" illustration and parts list.)
23	96210	1		GROMMET

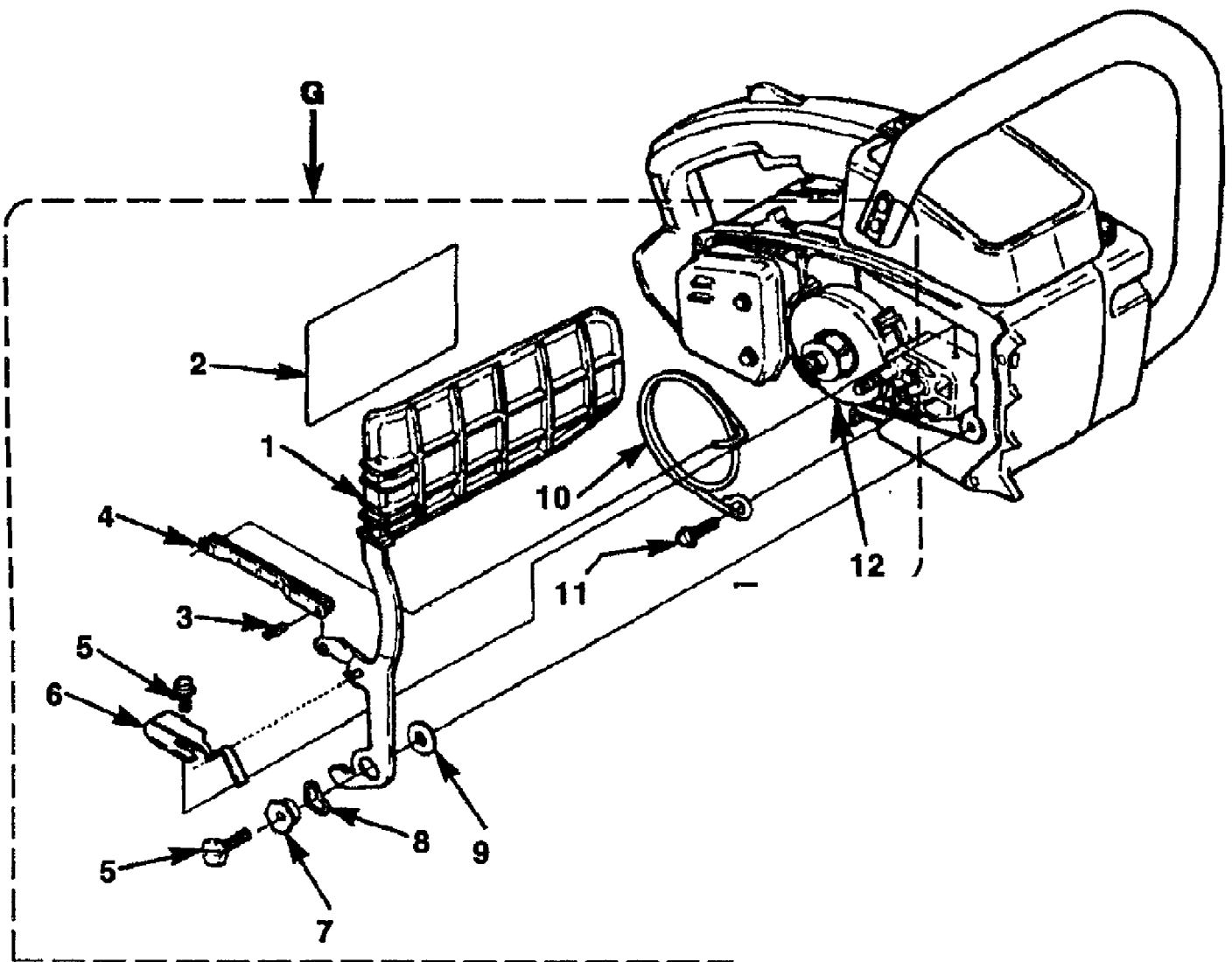

240 Super Chain Saw UT-10718-B
Chain Break

Page 4 of 14

Ref #	Part Number	Qty	S/P/F	Description
G	A97800A	1		CHAIN BRAKE KIT
1	A97179	1		HAND GUARD
2	95395A	1	/P	PIN-Roll
3	02261	1		DECAL-Warning
4	A70767	1		LINK-Pivot
5	80049	2	/P	SCREW-Hex Cap (1/4-20 X 5/8")
6	95406	1		CLIP-Retaining
7	96170	1		CAP-Brake Lever
8	95486	1		WASHER-Curved
9	95397	1		WASHER-Thrust
10	95482	1	S	BAND-Brake
11	88063	1	/P	SCREW- Hex (10-24 X 5/8")
12	A97056	1	/P	SPROCKET & DRUM

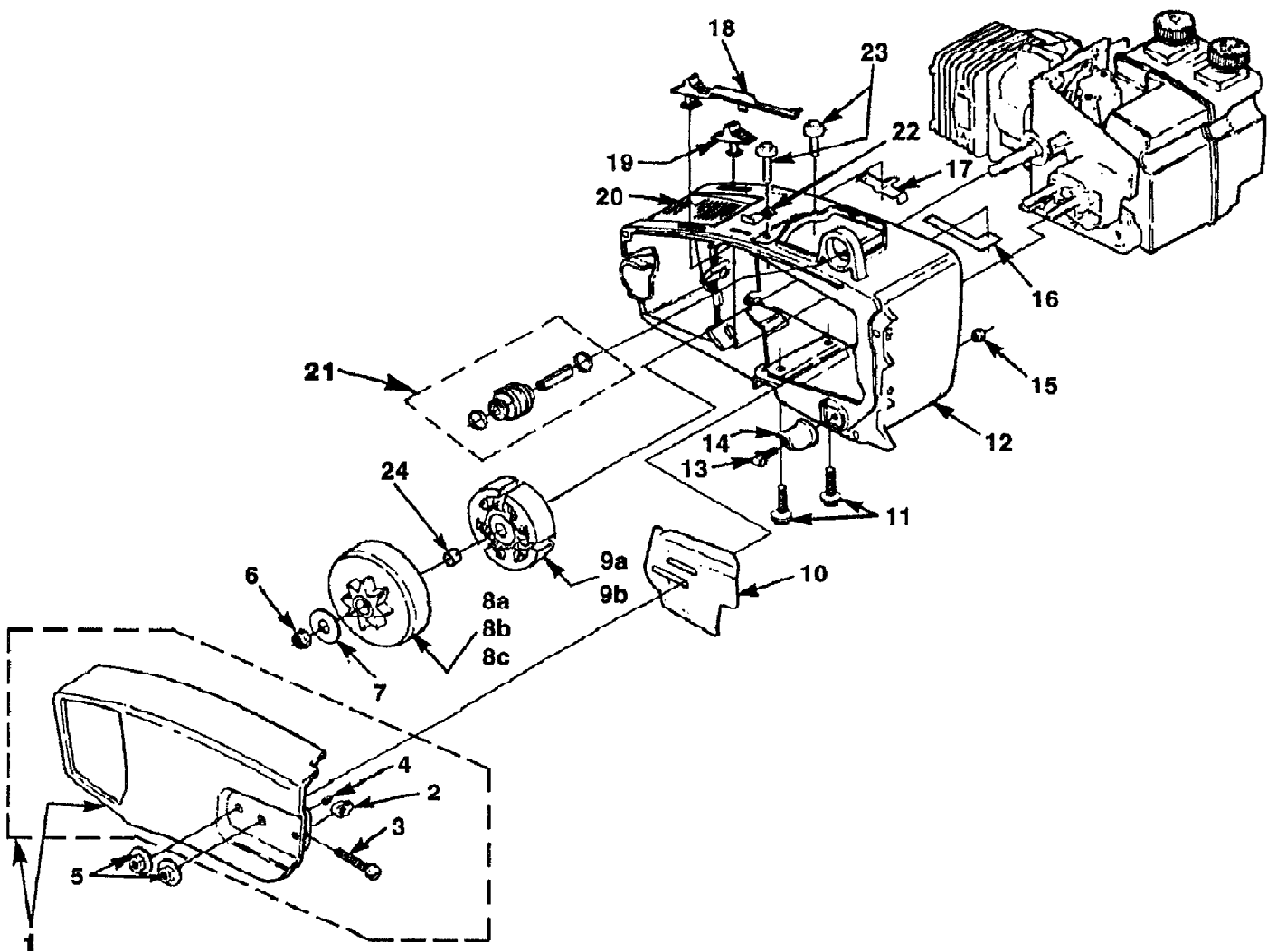

240 Super Chain Saw UT-10718-B
Engine Housing - Clutch

Page 6 of 14

Ref #	Part Number	Qty	S/P/F	Description
1	A01058B	1	/P	COVER-Drive Case
2	692542	1	/P	PIN-Guide Bar Adjusting
3	A00440	1	/P	SCREW & E-RING KIT
4	93574	1	S	E-RING
5	81258	2	S	NUT-Flange (1/4-20)
6	81229A	1	/P	NUT-Locking (5/16-24)
7	95299	1	/P	WASHER-Thrust
8A	A97172B	1	/P	SPROCKET, DRUM & BEARING (.375-6T) (2 11/16" I.D.)
8B	A97056	1	/P	SPROCKET, DRUM & BEARING (.325-8T) (2 11/16" I.D.)
8C	A95650B	1	S	SPROCKET, DRUM & BEARING (.375-6T) (2 7/16" I.D.)
9A	A98129	1	S	CLUTCH (2 11/16" O.D.)
9B	A979561A	1	/P	CLUTCH (2 7/16" O.D.)
10	95390	1		PLATE-Guide Bar
11	88051	1		SCREW-Hex Sems (10-24 X 3/4")
12	A96754B	1		HOUSING-Engine
13	82593	1	/P	SCREW-Mach. Hex Hd. (10-24 X 5/8")
14	95212	1	/P	STOP-Chain
15	81256	2	/P	NUT-Lock (10-24)
16	95091	1		CONTACT-Stop Switch
17	95087	1	/P	SPRING-Stop Switch
18	95050	1	S	BUTTON-Choke
19	95086A	1		BUTTON-Stop Switch
20	03154B	1		DECAL-Warning
21	A06391	1		VIBRATION ISOLATOR KIT
22	97993	1		BRACE-Clutch
23	88063	4	/P	SCREW-Hex Sems (10-24 X 5/8")
24	70277	1	S	BEARING-Clutch & Drum

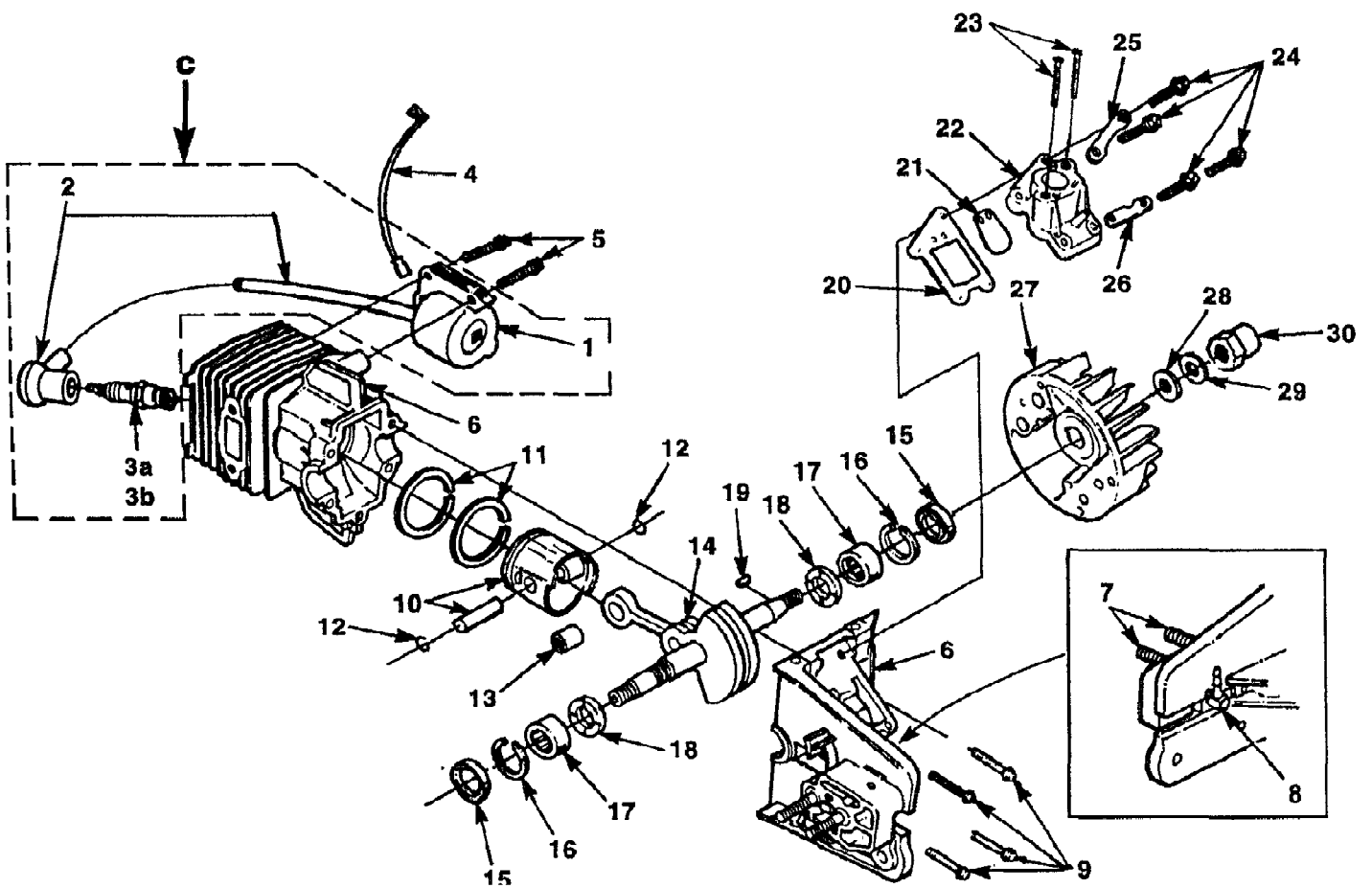

Ref #	Part Number	Qty	S/P/F	Description
C	A04446	1	S	IGNITION KIT
1	94711CS	1	/P	MODULE-Ignition
2	A94754	1		TERMINAL-High Tension Lead
3A	96169S	1	S	SPARK PLUG (DJ-7Y)
3B	79252	1	S	SPARK PLUG (RDJ-7Y) (UT10713, 10715-A)
4	A96378	1	S	LEAD-Ground
5	82430	2		SCREW-Machine Hex Hd. (8-32 X 7/8")
6	A96753A	1		CRANKCASE & CYLINDER
7	96083	2	/P	BOLT-Guide Bar
8	50558	1		FITTING-Tube
9	96624	4	/P	SCREW-Sems Hex Hd. (10-24 X 1 1/8")
10	A96751A	1		PISTON & PIN
11	94916	2		PISTON RING
12	65261	2	/P	RING-Retaining
13	97125	1		BEARING-Needle (After Lot #E229)
14	A96752A	1		CRANKSHAFT
13	95439	1		BEARING-Needle (Prior to Lot #E229)
15	07025	2	S	SEAL-Shaft
16	68514	2		RING-Retaining
17	12530	2		BEARING-Needle
18	95492	2		BEARING-Thrust
19	69250	1	/P	KEY-Woodruff
20	94873	1		GASKET-Manifold
21	95983	1	S	REED
22	A06326A	1	S/P	MANIFOLD-Intake
23	82545	2		SCREW-Plastite (#8-16 X 1 3/4")
24	82291	4		SCREW-Hex Washer (8-32 X 5/8")
25	96539	1		WASHER-Intake Manifold
26	96540	1		WASHER-Intake Manifold
27	A04158	1	S	ROTOR & STARTER PAWLS
28	84065	1	S	WASHER-Flat
29	83002	1	/P	WASHER- Lock
30	96255	1		NUT-Guide

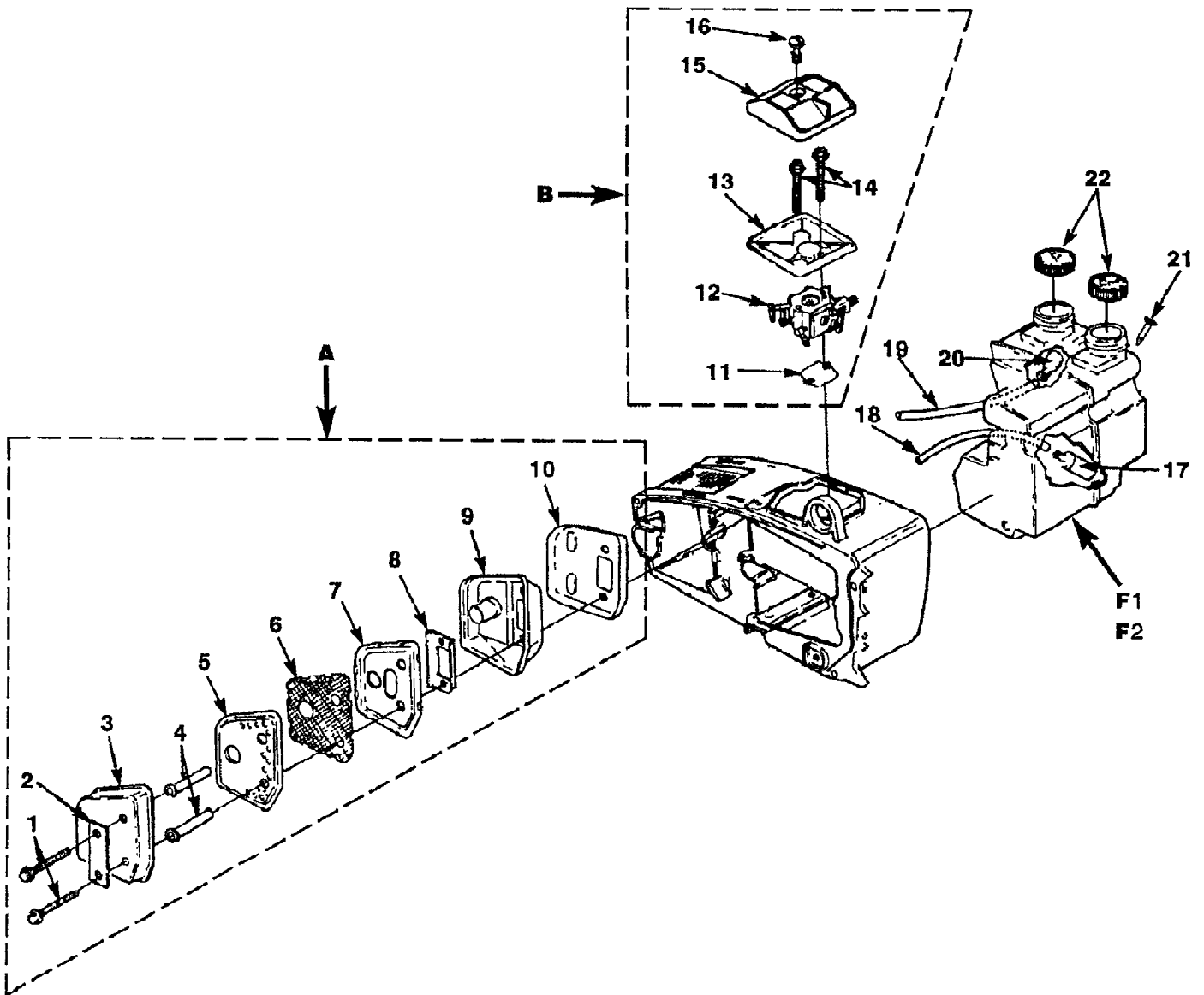

240 Super Chain Saw UT-10718-B
Muffler - Carburetor - Tank

Page 10 of 14

Ref #	Part Number	Qty	S/P/F	Description
A	A96931	1		MUFFLER-Complete
1	95005	2		SCREW-Mach. Sems Hex (10-24 x 2 1/16")
2	97751	1		BRACKET-Muffler
3	948871	1		CAP-Muffler
4	9398308	2		SPACER-Muffler
5	948811	1		BAFFLE-Muffler
6	956371	1		SCREEN-Spark Arrester
7	96928	1		BAFFLE-Muffler
8	94889	1		PLATE-Muffler
9	A96930	1		BODY-Muffler
10	96925	1		DEFLECTOR-Exhaust
B	A06438	1		CARBURETOR KIT
11	95022A	1	S	GASKET-Carburetor
12		1		UNKNOWN
?12A	07240	1	S	CARBURETOR-Walbro
13	95083	1	/P	CUP-Filter
14	96176	2		SCREW-Mach. Hex (10-24 X 1 5/8")
15	A96349	1		FILTER ELEMENT (Top)
16	95217	1		SCREW-Retaining
?12B	A96352B	1	S	CARBURETOR-Zama
F1	A02970A	1	/P	TANK-Fuel & Oil (UT10625-B,C,D; UT10630-A,B,C; UT10633-A,B; UT10635-D; UT10715,C,D; UT10717-A,B,C; UT10718-A,B,C)
F2	A01162A	1		TANK-Fuel & Oil (UT10635-C, UT10713, A; UT10715-A,B)
17	49422	1	S	FILTER-Fuel
18	0745426	1		TUBING-Rubber (6 1/2")
19	0745428	11	S	TUBING-Rubber (7")
20	A68593	1		FILTER-Oil
21	98819	2	/P	VALVE-Duck Bill
22	A97359A	2	S	CAP-Fuel & Oil

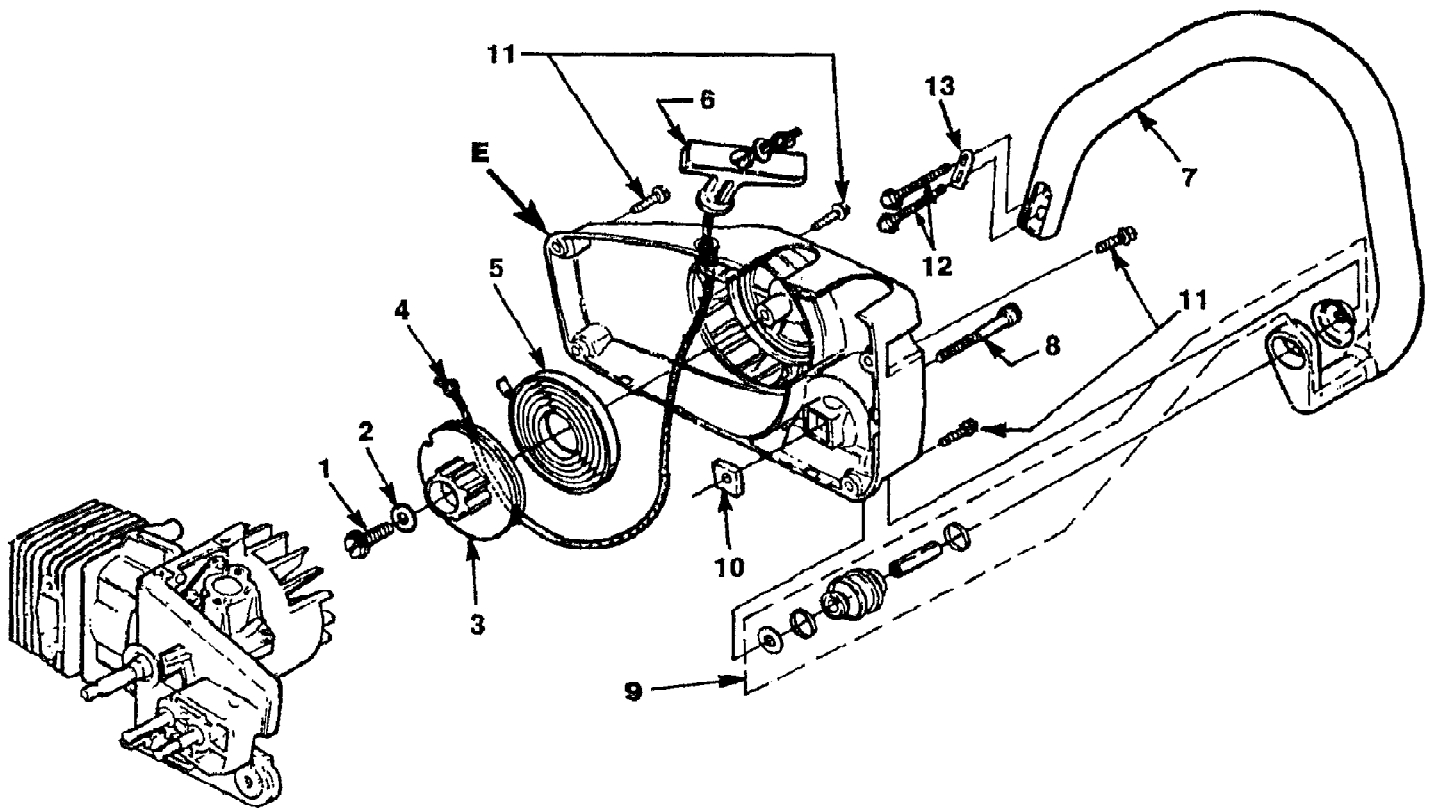

240 Super Chain Saw UT-10718-B
Starter - Front Handle

Page 12 of 14

Ref #	Part Number	Qty	S/P/F	Description
E	A98005B	1	/P	STARTER, Complete
1	82563	1	/P	SCREW- Thread Forming (#10 X 3/4")
2	94062	1	/P	WASHER-Retainer
3	97768B	1	S	PULLEY-Starter
4	9789901	1	/P	ROPE-Starter
5	A97908	1	/P	SPRING & CONTAINER
6	02264	1	S	GRIP-Starter
7	A06436	1		HANDLE BAR KIT
8	96818	1	/P	SCREW-Socket Hd. (10-24 X 5/8")
9	A06391	1		VIBRATION ISOLATOR KIT (See "Engine Housing Clutch Illustration and part list.)
10	95213	1		NUT-Square (10-24)
11	82563	4	/P	SCREW-Thread Form (10-24 X 3/4")
12	82218	2	/P	SCREW-Hex Washer (10-24 X 1 1/8")
13	96901	1		PLATE-Handle Bar

No
Diagram
Available

Parts List
Only

Ref #	Part Number	Qty	S/P/F	Description
24823	24823	1	S	SILASTIC (Crankcase Sealing)
23488C	23488C	1		LOCTITE
A24747A	A24747A	1		PULLER-Magneto Rotor
46130	46130	1		SCREW-Mach. Hex (5/16-18 2")
81196	81196	2	S/P	NUT-Hex (5/16-18)
A93791	A93791	1	/P	WRENCH-Spanner (Clutch)
23717A	23717A	1	/P	PIN-Clutch Spanner
A17705	A17705	1	S	WRENCH-Combination
18453	18453	1	/P	GREASE-Multi-Use
0745499	0745499	1	/P	TUBING-Rubber (10ft.)
A06439	A06439	1		FASTENER KIT
DA70776C	DA70776C	1		SAFE*T*TIP (Standard on units)
93695	93695	1		SCREW (Special)
9520199	9520199	1	/P	TUBING-Rubber (10ft)
68848	68848	1	/P	ROPE-Starter (250 ft. #4) (Prior to Lot #G080)
98052A	98052A	1	/P	ROPE-Starter (250 ft. #3 1/2") (After Lot #G080)
A97046	A97046	1		BUMPER-Spiked
82415	82415	1		SCREW-Mach. Flat (10-24 X 1/2")
80672	80672	1	S	SCREW-Mach. Pan (10-24 X 1/2")
81256	81256	2	/P	NUT-Locking Hex
GP203225	GP203225	1		IGNITION TEST KIT
17789	17789	1	S	CARBURETOR TOOL