

The Green Machine®

OWNERS MANUAL MODEL 700 (UT26010) MODEL 770 (UT26011) ELECTRIC WEEDER/CULTIVATOR

To ensure maximum performance and safe operation read and understand this manual before operating unit.

HMC — THE GREEN MACHINE ONE YEAR LIMITED WARRANTY

HMC warrants your HMC Product to be free from defects in material and workmanship under normal residential use for a period of one (1) year from date of purchase. This warranty expires in (45) days if the product is used commercially.

Should your HMC Product fail within the warranty period due to defective parts or workmanship, just return the unit transportation prepaid to either (1) the retailer who sold it to you or (2) directly to the HMC Factory Service Center, 20710 South Alameda Street, Long Beach, California 90810, U.S.A., or (3) to your regional distributor, whose address is available from HMC or your retailer. HMC will, at its option, repair or replace the unit at no charge. HMC assumes no obligation to pay the registered owner a cash refund under any circumstances.

Please return the enclosed warranty card within 10 days after purchase. If we do not have the card on file we will require other proof of purchase before completing the repairs. This warranty only extends to the original purchaser of the product.

This warranty does not apply if the product has been misused or used contrary to the instruction manual or if it has been repaired or altered by anyone other than an HMC authorized service center.

This warranty applies only to parts or components which are defective and does not cover repairs necessary due to normal wear, misuse, accidents, or lack of proper maintenance.

Regular, routine maintenance of the unit to keep it in proper operating condition is the responsibility of the owner.

HMC IS NOT LIABLE FOR INDIRECT OR CONSEQUENTIAL DAMAGES IN CONNECTION WITH THE USE OF THE PRODUCT INCLUDING ANY COST OF PROVIDING SUBSTITUTE EQUIPMENT DURING PERIODS OF MALFUNCTION.

Some states of the U.S.A. do not allow the exclusion of incidental or consequential damages, so the above exclusion may not apply to you.

Your HMC Product will perform as indicated in the instruction manual and in the accompanying literature. Your retailer may have sold you the machine with a promise that it would handle a particular task. You may return the machine to him if it does not perform that specific task, but we cannot be responsible for promises which are beyond the scope of the above instruction manual or literature.

THERE ARE NO EXPRESS WARRANTIES OTHER THAN AS CONTAINED IN THIS STATEMENT, AND ANY IMPLIED WARRANTIES SHALL EXPIRE 90 DAYS AFTER DATE OF PURCHASE. Some states of the U.S.A. do not allow limitations on how long an implied warranty lasts, so the above limitations may not apply to you.

This warranty gives you specific legal rights and you may also have other rights which vary from state to state or from country to country.

**CAUTION
READ OPERATING
PRECAUTIONS**

**CAUTION
READ OPERATING
PRECAUTIONS**



20710 ALAMEDA ST., LONG BEACH, CALIFORNIA 90810 • (213) 603-9888 • TELEX 696396

GM 715

ASSEMBLY

1. ATTACHING AND REPLACING BLADES (Figures 1&2)

- Install the blades exactly as shown in Figure 1. Incorrect assembly will cause the blades to loosen during use.
- **Note:** The blade plates must be assembled with the rounded edges facing the blade and the word "OUT" facing outward.
- Tighten the blade bolts as tight as possible using the method shown in Figure 2.

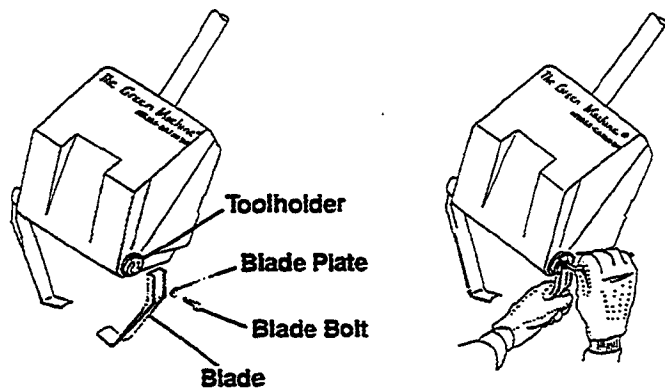

Fig. 1

Fig. 2

NOTE: The blade bolts must be checked for tightness and tightened if loose before each usage.

2. INSTALLING THE MID-HANDLE (Figures 3&4)

- Snap mid-handle over the handle tube (top of handle should angle back toward upper end of unit).
- Position handle support as shown. (Figure 3).
- Install bolt thru handle. Install flat washer and wingnut.
- Position handle for best operator comfort and tighten securely.

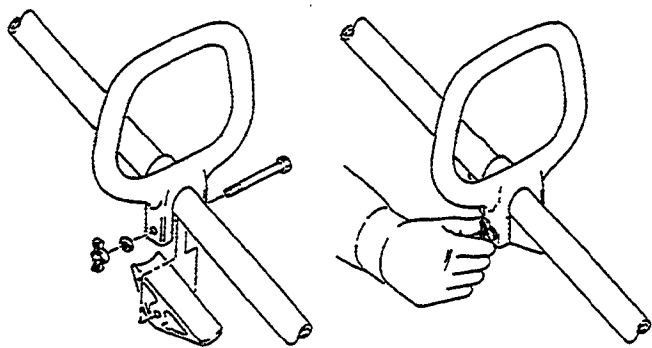

Fig. 3

Fig. 4

- The proper extension cord is a requirement for safe and efficient use of **THE GREEN MACHINE® WEEDER/CULTIVATOR**. Use only UL approved outdoor extension cord with maximum length of 100 feet (minimum 16 gauge).
- To secure the extension cord to your trimmer, loop the cord and push it through the plastic loop in the upper handle. (Figure 5).

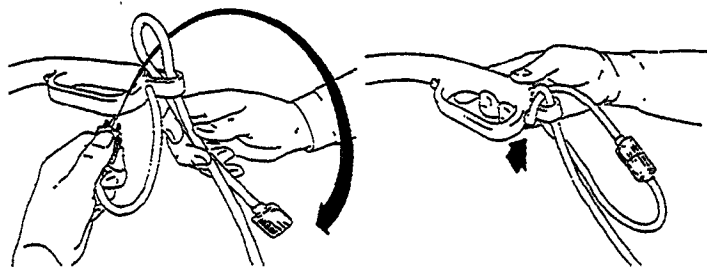

Fig. 5

Fig. 6

- Thread the supply cord of your **WEEDER/CULTIVATOR** through the extension cord loop and plug it in. This will ensure that the plugs will not become disconnected during operation. (Figure 6).
- Plug the extension cord into any wall receptacle. Hold your **WEEDER/CULTIVATOR** off the ground and pull the trigger. **CAUTION:** Do not use with 220 volt power or D.C. current.

OPERATING PRECAUTIONS

1. Read and understand Operator's Manual before using your **GREEN MACHINE**. Be thoroughly familiar with proper use of the **WEEDER/CULTIVATOR**.
2. Never allow children to operate the **WEEDER/CULTIVATOR**. It is not a toy. Never allow adults to operate unit without first reading the Operator's Manual.
3. Do not use in rain.
4. Keep the area of operation clear of all persons, particularly small children and pets.
5. Dress Properly — Do not wear loose clothing or jewelry. They can be caught in moving parts. Always wear substantial footwear and long pants.
6. Use the right appliance — Do not use the appliance for any job except that for which it is intended.
7. **WARNING.** To prevent the risk of electrical shock, use only with an extension cord suitable for outdoor use. You may obtain extension cords from your **GREEN MACHINE** retailer.
8. Extension cord — To prevent disconnection of the power supply cord from the extension cord during operation, properly connect cord as shown in Figures 5&6.
9. Avoid Unintentional Starting.
10. Don't abuse cord — Never yank cord to disconnect from receptacle. Keep cord away from heat, oil and sharp edges. Replace damaged cords.
11. Always be sure of your footing; keep a firm hold on the handle and walk, never run.
12. Stop the motor and unplug the power supply cord whenever you leave the **WEEDER/CULTIVATOR**, or when making any repairs or inspections.
13. When not in use, store your **WEEDER/CULTIVATOR** in a dry place out of the reach of children.
14. Keep all fasteners tight to be sure the **WEEDER/CULTIVATOR** is in safe working condition. Follow maintenance instructions provided in this manual.
15. Never operate without proper guards or protective safety devices in place.
16. If the **WEEDER/CULTIVATOR** should start to vibrate abnormally or become noisy, stop the motor and check immediately for the cause. Abnormal noise is generally a warning of trouble.
17. When servicing use only identical replacement parts. Replace or repair damaged cords.

18. Do not operate your **WEEDER/CULTIVATOR** after it has been dropped or damaged. Return it to your nearest authorized service dealer for inspection and repair.
19. Check the blade bolts for tightness before each usage.

OPERATING THE WEEDER/CULTIVATOR

NOTE: Read operating precautions before using **THE GREEN MACHINE® WEEDER/CULTIVATOR**.

- **THE GREEN MACHINE® WEEDER/CULTIVATOR** will weed, cultivate and mix soil in difficult and hard-to-reach places with surprising accuracy and control. This tool provides a totally new time-saving method of weeding and cultivating that will enable you to work closely under and around trees, shrubs, flowers, sidewalks, and garden plants that once required the most careful manual work. As you learn the techniques of this new and versatile tool, more and more uses for it will arise.
- Always wet the soil (preferably the night before), when using your **WEEDER/CULTIVATOR**, as this will loosen the soil and make the job easier. **Remember this tool is not a tiller for rock hard soil, but a cultivator intended for soil maintenance.**
- The more water you apply to the work area, the looser and easier the soil will be to work. The blades of your **WEEDER/CULTIVATOR** will not become clogged, even in the wettest soil conditions.
- Your **WEEDER/CULTIVATOR** should be used much like you would use a gardening hoe except that this tool does the work for you. Pull the trigger to start it and place it on the soil in front of you. With the least amount of pressure on the mid-handle, the blades will dig themselves into the soil.
- Then **PULL THE UNIT TOWARD YOU** while it is digging beneath the soil's surface. (Figure 7).



Fig. 7

PULL IT —
The Unit Works Like A Hoe

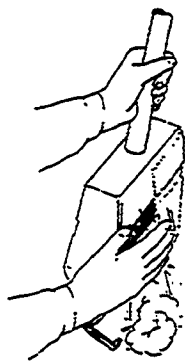

Fig. 8

- At the end of the pulling stroke, lift it slightly out of the soil and reach forward to begin another stroke with the unit still running. It is not necessary to release the trigger after each pass. (Figure 7).
- After each pass, move to the right or left to begin your next pass. Continue making passes in the same direction until you have covered the area you wish to work.

- Usually it takes two passes in the same path to thoroughly mix the soil and cut the weed roots, so your first pass may look as if you haven't mixed the soil at all. However, your first pass has cut the soil cleanly beneath the surface, including all the weed roots.
- For best cultivating results, your second pass over the soil should be at a perpendicular angle to your first pass. When you have made two passes over your work area in a crisscross pattern (Figure 7), you have effectively mixed every inch of soil, and removed all the weeds at the same time.
- Your **WEEDER/CULTIVATOR** will effectively cultivate to a depth of 4¾ inches (120.6 mm.). The action of the blades will bring any cut off weeds (and their roots) to the surface to be raked away, leaving a professionally manicured look to your flower beds or garden.
- Soil not cultivated for a period of time will be harder to work the first time. Regularly maintained soil will be much easier to cultivate and will give you the time-saving benefits of your **GREEN MACHINE WEEDER/CULTIVATOR**.
- Allow your **WEEDER/CULTIVATOR** to do the work for you. Forcing the unit will only wear out the operator and shorten its life expectancy.

GENERAL MAINTENANCE

- Be sure your **WEEDER/CULTIVATOR** is unplugged before any maintenance.
- Keep the exterior of your **WEEDER/CULTIVATOR** clean by wiping with a damp cloth. **DO NOT USE A HOSE OR ANY PETROLEUM MATERIAL. CLEAN AFTER EACH USE.**
- After each use, clean the air intake vent of any dirt or debris that might block the air flow by wiping your finger across the vents. (Figure 8).
- Before each use, re-tighten the blade bolts securely.
- Check and tighten all fasteners. If any parts are damaged, replace immediately.

DOUBLE INSULATION

Double Insulation is a concept in safety, replacing the standard grounded supply system in electric power tools. The construction of a double insulated tool affords compatible protection to a properly grounded tool without the necessity of using a grounded conductor. The double insulation system eliminates the need for the usual three wire grounded power cord and grounded supply system. Whenever there is electric current in the tool, there are two complete sets of insulation to protect the user. All exposed metal parts are isolated from the internal metal motor components with protecting insulation. The lead wires, switch, etc., with their functional insulation, have added protection of non-conductive sleeving or housings to complete the double insulation system.

WARNING: YOUR WEEDER/CULTIVATOR IS PROTECTED BY A MANUAL RESET OVERLOAD DEVICE. WHEN THE UNIT IS OVERLOADED, AS WHEN WORKING IN HARD OR ROCKY SOIL, THIS DEVICE WILL "OPEN", STOPPING THE MOTOR. WAIT 10 SECONDS THEN PUSH THE WHITE BUTTON TO RESUME USE OF THE MACHINE. DO NOT STALL THE MOTOR.

How to cultivate new territory.

MULTI-FUNCTION TOOL:

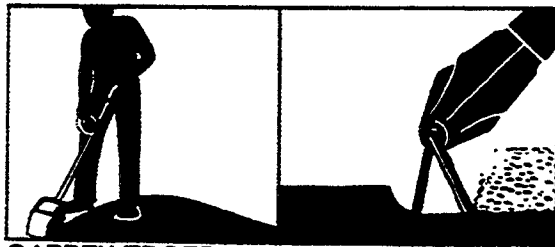

GARDEN-EDGER

CULTIVATOR

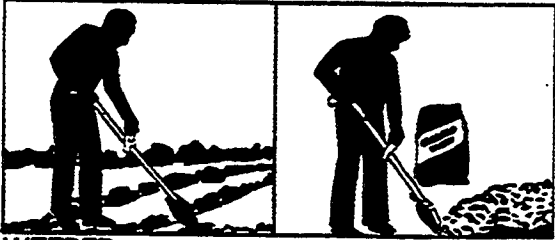

WEEDER

SOIL-MIXER

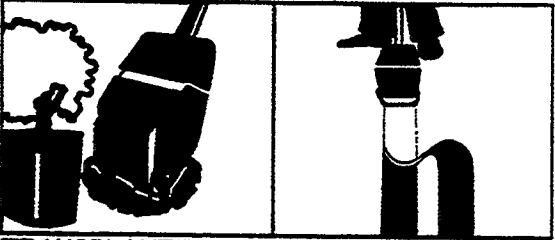

TRANSPLANTER

MINI-SOD CUTTER

- Unique multi-functional tool
- Removes weeds
- Aerates soil
- Edges gardens
- Transplants
- Plant food mixer
- Cuts sod
- Replaceable reciprocating blades
- Self-cleaning, non-clogging

HMC

20710 Alameda St., Long Beach, California 90810

(213) 603-9888